

# DM-18

## Manual Dough Press

### OWNER'S MANUAL



**doughXpress**®

For Customer Service, Call **1-800-835-0606 ext. 205**  
or Visit **www.doughXpress.com**

#### CONTENTS

Receiving & Setup .....	2
Operation .....	3
Setting Temperature & Time .....	4
Preference Settings .....	5
Machine Presets .....	6-7
Cycle Count .....	8
Temperature & Time Modes .....	9
Pressing Dough .....	10-11
Dough Weights & Shrinkage .....	12
FAQs .....	13
Troubleshooting .....	14
Cleaning & Maintenance .....	15
Warranty .....	16

**BEFORE warranty repair you MUST get Prior Authorization:**

# RECEIVING & SETUP

● ● ● ● PLEASE READ THIS MANUAL IN ITS ENTIRETY ● ● ● ●  
BEFORE OPERATING YOUR PIZZA PRESS.

## INSPECTION

Inspect your box and machine for hidden shipping damage. Contact the delivery company immediately, should you find damage.

## PLATEN SURFACE

Slight surface imperfections are a normal part of the aluminum casting process for the platens on your press. These are not considered a defect and do not affect the functionality of the machine in any way.

## SHIPPING OR RETURNS

**NOTE:** Save all of your shipping/packing materials.

**DO NOT RISK COSTLY SHIPPING DAMAGE!  
SHIP ONLY IN ORIGINAL BOX.**

1. Fasten machine to plywood shipping base with bolts provided.
2. Make sure handle is pressed down so that the heat platen will not swing around during shipment.
3. Place in original box, and put side liner and top liner in place. Fold in flaps and seal the box.

***\*Additional bottom boards, box and liners may be obtained from your supplier for a nominal cost.***

## INSTALLATION

1. Lift press from box and place on cart or counter top.
2. Remove plywood shipping base from press.

**CAUTION:** Heavy lifting can cause injury. We recommend two person lifting or use of a mechanical aid when handling this press. Remember to always maintain natural curves of back and bend knees to lift.

3. Plug the cord of the press into a correctly grounded electrical outlet. The correct voltage is indicated on the identification tag of the press.

**NOTE:** Upon receiving your new equipment, some debris or residue may be present on the aluminum platen(s). Clean the platens per the instructions provided prior to first use.

4. Remove wrap from handle and platens.

**WARNING:** Do not use an extension cord to supply power to your press.

This machine is designed in accordance with the NSF/ANSI standard for sanitation to be sealed to the countertop to prevent the harborage of vermin and the accumulation of dirt and debris. To comply with this standard the end customer must seal around the perimeter of the base of the machine to the countertop with a food grade RTV silicone sealant that is certified to the NSF/ANSI 51 standard such as Dow Corning #732 Multipurpose Sealant.

# OPERATION

## PREPARATION

1. Turn on the machine by pushing the on/off switch.

Startup/Splash screen is displayed as the controller boots up.

**NOTE:** The current program number and the software revision of the controller are displayed at startup. (*The default settings are program number P 11 for °F, P 12 for °C and software revision RV 1.0*)



Startup/Splash Screen

After boot up, the home screen is displayed showing the current heat platen temperature and set cycle time. The heat indicating lamp is represented by the snowflake in the upper left corner of the display. The heat indicating lamp will display anytime the heating element is heating and will cycle on and off after the set temperature is reached to maintain set temperature.

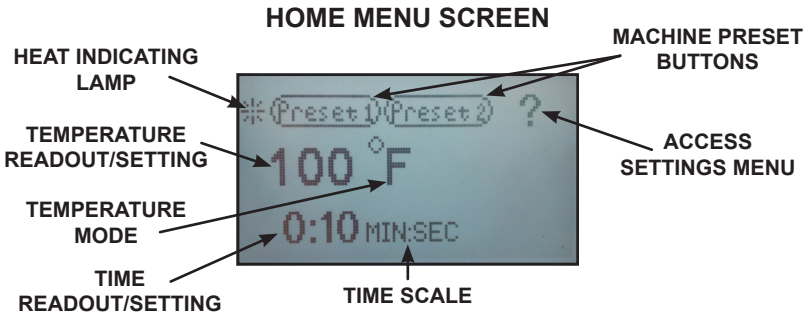

# SETTING TEMPERATURE & TIME

## ADJUST TEMPERATURE:

### TEMPERATURE ADJUSTMENT SCREEN



1. Touch the temperature readout on the display. “UP” ▲ and “DOWN” ▼ arrows will appear on the right side of the display and the temperature value will start flashing and to indicate it is in set mode.
2. Press the “UP” ▲ or “DOWN” ▼ arrow to change the temperature value. Holding down on an arrow will change the temperature in 1 degree increments for 10 values; then change to 10 degrees incremental changes.
3. Once the desired temperature value is set, either press the temperature value to lock the set temperature or simply wait for 2 seconds and it will lock in the new value automatically.

## ADJUST CYCLE TIME:

### TEMPERATURE ADJUSTMENT SCREEN

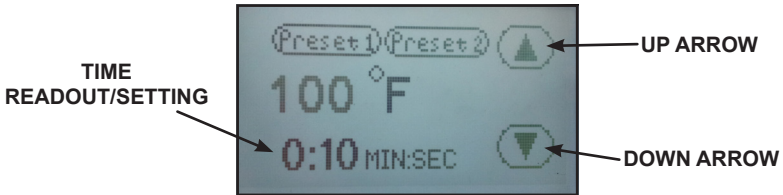

1. Touch the time readout on the display. “UP” ▲ and “DOWN” ▼ arrows will appear on the right side of the display and the cycle time value will start flashing and to indicate it is in set mode.
2. Press the “UP” ▲ or “DOWN” ▼ arrow to change the cycle time value. Holding down on an arrow will change the time in 1 second increments for 5 values; then change to 10 seconds incremental changes.
3. Once the desired cycle time value is set, either press the time readout to lock the cycle time or simply wait for 2 seconds and it will lock in the new value automatically.

# PREFERENCE SETTINGS

## SETTINGS:

1. Press the “?” on the upper right corner of the display on the **Home Menu Screen** to access the settings menu.
2. Press the settings sub menu title to be adjusted.

### SETTINGS MENU SCREEN

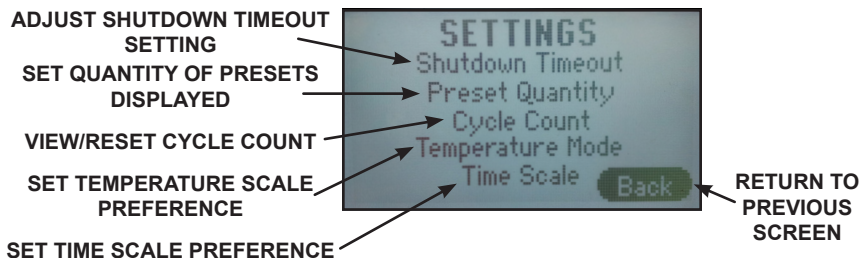

## SHUTDOWN TIMEOUT

The shutdown feature shuts off the heat to the press after a period of inactivity.

### SHUTDOWN TIMEOUT ADJUSTMENT SCREEN

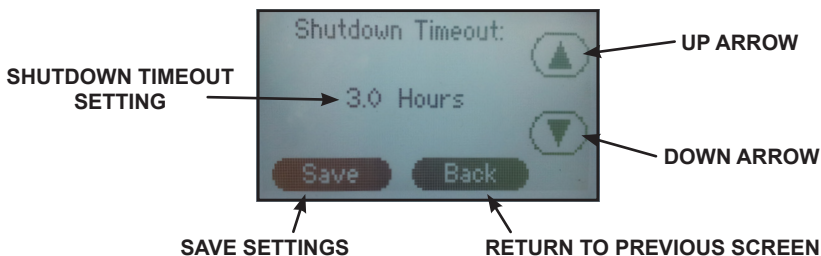

**NOTE:** The factory default is set at 3.0 hours.

1. From the settings menu press the “**Shutdown Timeout**” sub menu title.
2. Press the “UP” ▲ and/or “DOWN” ▼ arrows to set the desired shutdown time.

**NOTE:** Shutdown time adjusts in 1/2 hour intervals. Press the “Down” ▼ button until “Disable” is displayed will deactivate this setting.

3. Press “**Save**” to save the setting.
4. Press “**Back**” to return to the previous screen.

**NOTE:** After the shutdown time has elapsed with the press idle, the heating element will stop cycling to maintain the set temperature and the home screen will display “**SHUTDOWN.**” Touching the display or closing the press will take the machine out of shutdown mode.

# MACHINE PRESETS

## PRESET QUANTITY

Temperature presets can be stored in the memory for different transfer settings. By default two presets are displayed. This setting can be adjusted to display four presets.

### PRESET QUANTITY DISPLAYED PREFERENCE SCREEN

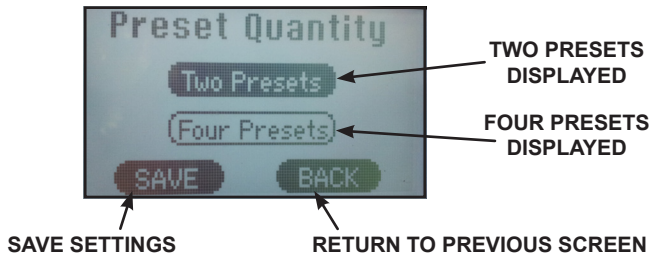

1. From the settings menu press the **“Preset Quantity”** sub menu title.
2. Press the number of presets to be displayed on the home screen, either **“Two Presets”** or **“Four Presets.”**

TWO PRESET DISPLAY  
ON HOME MENU SCREEN

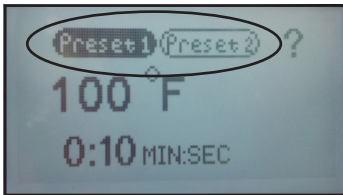

FOUR PRESET DISPLAY  
ON HOME MENU SCREEN

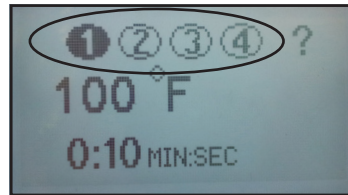

3. Press **“Save”** to save the setting.
4. Press **“Back”** to return to the previous screen.

# MACHINE PRESETS

## STORING PRESETS:

**NOTE:** The factory default settings for all presets is set to 200°F and 10 seconds.

### HOME MENU SCREEN

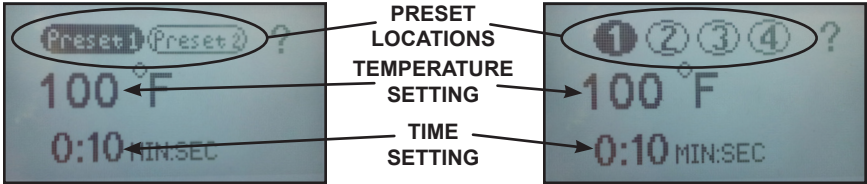

1. Set the desired temperature and/or cycle time using the temperature and time adjustment instructions in this document.
2. Press and hold the desired preset location for two seconds. The controller will beep and the preset location button will display in reverse indicating the preset is stored in memory.

## RECALLING PRESETS:



**PRESET 1 SELECTED**  
(two preset setting shown)

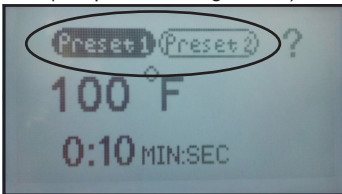

**PRESET 2 SELECTED**  
(two preset setting shown)

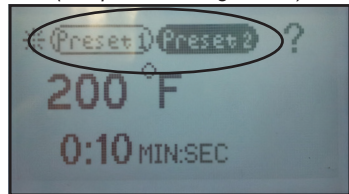

1. Press and release for approximately 1/2 second the preset button to recall. The controller will beep and the preset location button will display in reverse indicating the preset has been changed.

**NOTE:** The new set values will display for 1 second before the controller starts adjusting the temperature or time to match the new set-point.

# CYCLE COUNT

## CYCLE COUNT

The cycle count feature counts the number of cycles that the machine has undergone. A cycle is counted every time the countdown timer is activated by closing the press.

**NOTE:** The cycle count will maintain the total count even if the power has been turned off.

## CYCLE COUNT/CYCLE COUNT RESET SCREEN

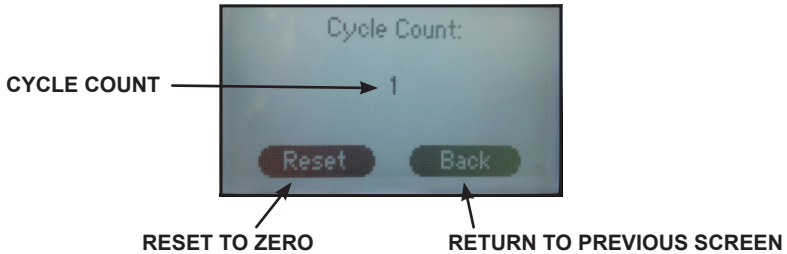

## TO RESET THE COUNTER:

1. From the settings menu press the **"Cycle Count"** sub menu title.
2. Press **"Reset."**
3. Press **"Back"** to return to the previous screen.



# TEMPERATURE & TIME MODES

## TEMPERATURE MODE

Temperature Mode controls which temperature scale is displayed on the controller home screen.

**F** = Fahrenheit

**C** = Celsius

### TEMPERATURE MODE PREFERENCE SCREEN

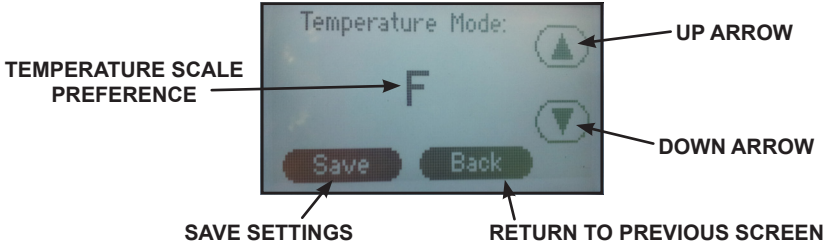

### TO CHANGE THE SCALE:

1. From the settings menu press the “**Temperature Mode**” sub menu title.
2. Press the “UP” ▲ or “DOWN” ▼ arrows to select the preferred temperature scale.
3. Press “**Save**” to save the setting.
4. Press “**Back**” to return to the previous screen.

## TIME SCALE

The time scale setting adjusts how the time is displayed on the home screen. There are three Time Scale display options available in the Time Scale menu:

- **MIN:SEC** (Factory Default)
- **SEC** (Seconds)
- **1/10 SEC** (1/10 Second Resolution)

### TIME MODE PREFERENCE SCREEN



### TO CHANGE THE SCALE:

1. From the settings menu press the “**Time Scale**” sub menu title.
2. Press the “UP” ▲ and/or “DOWN” ▼ arrows to select the preferred time scale.
3. Press “**Save**” to save the setting.
4. Press “**Back**” to return to the previous screen.

# PRESSING DOUGH

## PRESSING DOUGH

Your pizza press is designed for easy use and operation to reliably press dough balls. Thickness, shape, and size are directly related to your dough ball, its shape, the temperature of the dough, the recipe of your dough, type of lubricating food oil, as well as the settings of your machine. You should experiment with the following for the results you want.

1. Move on/off switch to “on”. Power light should come on.

**\*Up is “ON” and down is “OFF”**

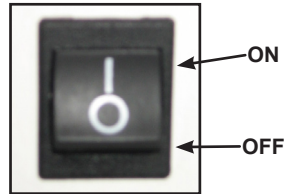

2. Set the desired temperature on the time/temperature control panel as instructed in this manual. Generally 110°-130°F for room temperature dough and 140°-150°F when using refrigerated dough. A temperature indicating alarm will sound once the set temperature has been reached.

**WARNING:** Never attempt to press frozen dough. Personal injury and damage to your machine could result!

**NOTE:** This symbol represents “Hot Surfaces”



3. With the press in the open position, adjust the press to the desired thickness by turning the thickness control knob located at the top/rear of the machine. Thickness is reduced by turning knob **clockwise** and increased by turning it **counterclockwise** as indicated below.

**Thickness knob**

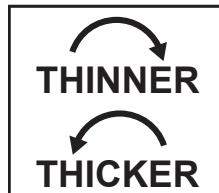
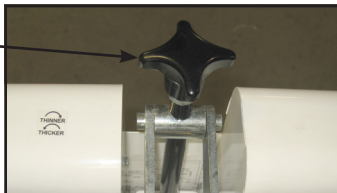

Thickness setting should be set so that the heat head will lock down firmly with your product in place.

**NOTE:** Adjustments may be required from one product to another and will vary to achieve the desired result.

## PRESSING DOUGH

**CAUTION:** Excessive pressure can cause structural damage, voiding the machine warranty!

**WARNING:** Make all adjustments while press is open. Adjusting the thickness while under pressure will result in damage to the press.

4. Lightly lubricate the lower platen with olive oil, food/cooking oil or other food release lubricant.
5. Place your preformed dough ball on the lower platen and add a small amount of your food lubricant to the top of the dough ball. **Do not add flour or dust with flour.**
6. Pull down the handle all the way, applying pressure, until it stops.
7. After the designated time has elapsed (generally, 3-10 seconds for room temperature dough, raise the handle all the way up to the open position.

**TIP:** Dough balls at room temperature gives you the best results.

8. Remove your flattened dough and place on screen or pan with the top side (side towards upper platen when pressed) face down. You are now ready for final shaping, edging, and toppings.
9. Move on/off switch to “OFF” when you are finished using the press for the day. This will turn power off to the entire machine.

# DOUGH BALL WEIGHTS

<u>PIZZA CRUST SIZE</u>	<u>WEIGHT OF THE DOUGH BALL</u>
6"	5-8 oz.
8"	6-10 oz.
10"	8-12 oz.
12"	16-18 oz.
14"	18-20 oz.
16"	20-22 oz.
18"	22-24 oz.

**NOTE:** Final Crust size is determined by combination of weight of dough ball and thickness setting.

## DOUGH SHRINKAGE

### WAYS OF OVERCOMING THIS PROBLEM:

Get an idea of the following:

#### 1. Recipe

- What is the percentage of water content in the dough?
- What is the percentage of oil content in the dough?

#### 2. Mixing

- Mixing procedure, such as water temperature and mixing speed.

#### 3. Dough Preparation

- What is the time between mixing and pressing?
- How is the dough being stored?

#### 4. Pressing

- What is the temperature of the dough when pressing?
- What is the temperature of the press when pressing?
- How long is the dough being pressed?

## **Q: Why won't my dough press to size?**

- Weight of the dough ball - *not enough dough*
- Temperature of the dough ball might be cold - *higher temp/ longer press time*
- Set to thick - *change thickness setting*

## **Q: When I press my dough it gets sticky? Why?**

- Very wet dough - *turn up temperature*
- Platens are not clean - *possible flour build up*

## **Q: Why won't my dough press out even?**

- Unlevel platens

## **Q: Why is my dough tearing when I press?**

- Usually this is caused by under mixing the dough in the mixer - *mix on slow speed for a minimum of 10 minutes*
- Cold or frozen particles in the dough

## **Q: What temperature should I be pressing the dough?**

- Cold dough could vary from 130°F to 170°F
- Warm dough or room temperature dough 100°-110°F

## **Q: How long should I be pressing the dough?**

- Warm dough 2-7 seconds
- Cold dough 5-10 seconds

## **Q: Will the heat kill the yeast?**

- NO - *yeast dies at 180°F for 2-minutes - The temperature we are pressing could range from 100°-170°F for a maximum pressing time of 10 seconds. This will not affect the yeast in the dough.*

## **Q: Is 18" the only size crust I can get with this press?**

- No - *The weight of the dough ball and your thick & thin setting will determine the size of your crust. Different dough ball weights will determine the size of your crust.*

## **Q: How do I get an edge with the press?**

- Press out dough normally - (2) ways you can get an edge...
  - a. *After pressing crust, form edge by hand*
  - b. *When saucing crust leave a 1/4" to 1/2" ring from the edge to let your oven bake the edge naturally for a nice handmade look.*

# TROUBLESHOOTING

## Timer Won't Count Down

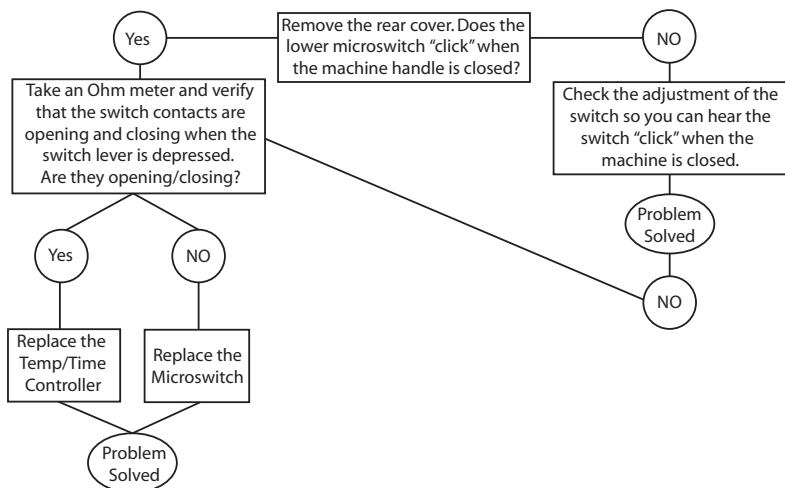

## Press is not Pressing Dough Evenly

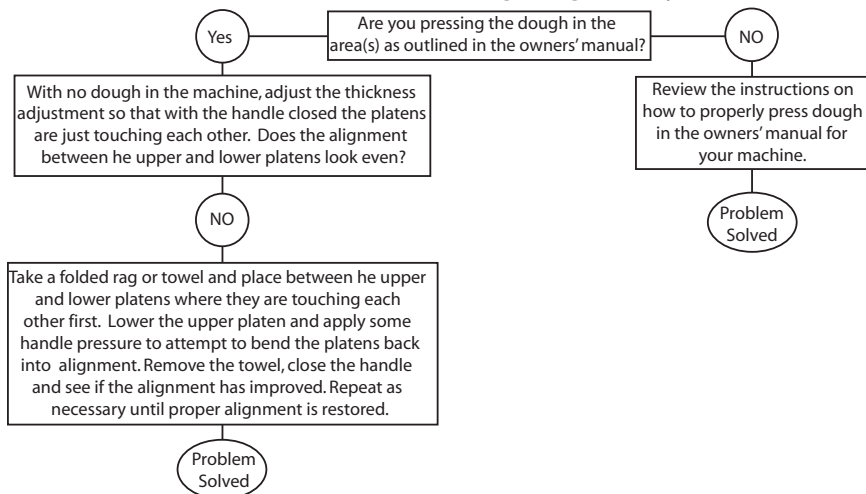

# CLEANING & MAINTENANCE

**WARNING:** Before cleaning, performing maintenance or repairs make sure the machine is turned off and the machine is unplugged.

**\*\*\*This appliance is not waterproof. Never spray or pour water or any other cleaning solution onto this appliance.\*\*\***

## CLEANING ALUMINUM UNCOATED HEAT PLATEN(S).

1. Unplug the machine and allow it to cool.
2. Open the heat platen for easier access.
3. Dampen a nonmetallic scrubbing sponge with a mild soap or detergent to remove any excess material from the heat platen(s).
4. Wipe clean with a dry cloth.

## CLEANING PTFE COATED PLATEN(S) (OPTIONAL FEATURE).

1. Unplug the machine and allow it to cool.
2. Open the heat platen for easier access.
3. Clean the PTFE coated platen with a mild soap and warm water applied with a soft cloth or sponge. Do not use steel wool, scrub sponges, kitchen or oven cleaners or any other kind of abrasive material. This will damage the coating.
4. Wipe clean with a dry cloth.

## CLEANING OUTSIDE SURFACES OF THE MACHINE

Use a mild soap and warm water applied with a soft cloth or sponge. Do not use steel wool, scrub sponges, kitchen or oven cleaners or other abrasives that will damage the painted surface.

## LUBRICATION

Your press requires lubrication every 15,000 cycles or every 6 months. Lubricate weekly in a heavy use production environment. Use NSF/NLG12 rated food grade grease (such as Bel-Ray No-Tox #2 or equivalent). A general purpose food grade machine oil spray is also acceptable such as CRC03055 lubricant (available from retailers such as Amazon). Lubricate all moving or hinged points.

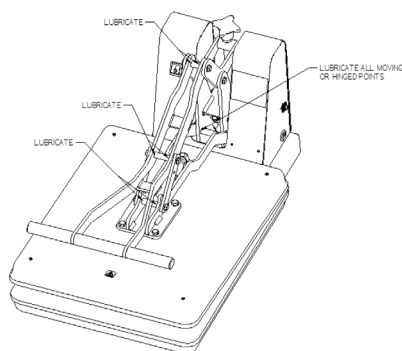

## CIRCUIT BREAKER RESETTING

Should the circuit breaker trip, simply allow the machine to cool for 2 minutes and then reset the circuit breaker by pressing the button back in to allow the machine to come back on. If the circuit breaker continues to trip, have an electrician diagnose the cause of the fault.

# WARRANTY



**BEFORE warranty repair you MUST get  
Prior Authorization: Call 1-800-835-0606**

**Warranty will be voided otherwise.**

## NOTICE

Our system will automatically register the equipment on the date it was shipped. If the equipment was not purchased directly from HIX, but through a distributor (either domestic or foreign), please keep a copy of their sales invoice showing the serial number and date it was sold/shipped to you with this warranty. In this case, we will use the distributor's invoice date as the beginning warranty date. **STAPLE A COPY OF YOUR RECEIPT TO THIS WARRANTY** and keep in a safe place to provide verification of your warranty should a problem occur. Thank you.

Please fill in the following information and attach a copy of your receipt for your records.

Date Purchased: \_\_\_\_\_ From: \_\_\_\_\_

Model #: \_\_\_\_\_ Serial #: \_\_\_\_\_

This warranty applies to equipment manufactured by the HIX Corporation (HIX), Pittsburg, Kansas, U.S.A. HIX warrants to the original purchaser its Dough, Tortilla and Poultry Presses against defects in workmanship and material, except for wear and tear for a period of "One Year" from the date of purchase. All dough press carts, compressors, and accessories are warranted for 90 days from the date of purchase.

In the event of a defect, HIX, at its option, will repair, replace or substitute the defective item at no cost during this period subject to the limitations of insurance and shipping costs stated below.

This warranty does not cover normal wear and tear, damages due to accident, misuse/abuse, alterations or damage due to neglect or lack of proper lubrication or maintenance. HIX shall not be responsible for repairs or alterations made by any person without the prior written authorization by HIX. This warranty is the sole and exclusive warranty of HIX and no person, agent, distributor, or dealer of HIX is authorized to change, amend or modify the terms set forth herein, in whole or in part.

In the case of a problem with the equipment identified herein, HIX Corporation should be contacted during regular business hours to discuss the problem and verify an existing warranty. HIX personnel will assist the customer to correct any problems which can be corrected through operation or maintenance instructions, simple mechanical adjustments, or replacement of parts. In the event the problem cannot be corrected by phone, and upon the issuance of a return authorization by HIX, the equipment shall be returned to HIX or an authorized service representative. All insurance and shipment/freight costs are solely the responsibility of the customer, and not that of HIX, and HIX shall not be responsible for improper handling or damage in transit. HIX customer service personnel may be contacted for complete return authorization and reconditioning information.

This expressed warranty is given in lieu of any and all other warranties, whether expressed or implied, including but not limited to those of merchantability and fitness for a particular purpose, and constitutes the only warranty made by HIX Corporation.

In no event shall HIX's liability for breach of warranty extend beyond the obligation to repair or replace the nonconforming goods. HIX shall not be liable for any other damages, either incidental or consequential, or the action as brought in contract, negligence or otherwise.

This warranty gives you specific legal rights and you may also have other rights which vary from state to state.

***HIX*** CORPORATION  
***Food Equipment Division***

1201 E. 27th Terrace • Pittsburg, KS 66762 • U.S.A.  
(620) 231-8568 • Fax: (620) 231-1598

E-Mail: [mail@hixcorp.com](mailto:mail@hixcorp.com) • Website: [www.doughxpress.com](http://www.doughxpress.com)

©2010 HIX Corp.