

# Continental

## Refrigerator

Project Name: \_\_\_\_\_  
 Model Specified: \_\_\_\_\_  
 Location: \_\_\_\_\_  
 Item No. \_\_\_\_\_ Quantity: \_\_\_\_\_

### Direct Draw Draft Beer Coolers

- Models:  KC50       KC59       KC69  
 KC79       KC90

### Standard Features

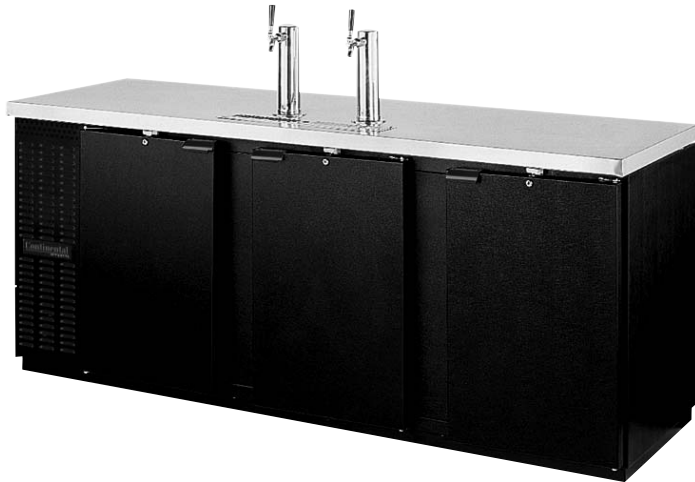

Model KC90

- Available in 50", 59", 69", 79", 90" Widths
- Modern, State-of-the-Art Styling
- Performance Rated Refrigeration System Utilizing Environmentally Safe R-134a Refrigerant
- Front Breathing
- Wear Resistant Black Painted Steel Exterior with 304 Series Stainless Steel Countertop
- Heavy-Duty, Long Lasting, Galvanized Steel Interior with Reinforced Stainless Steel Floor
- Stainless Steel Reinforced Threshold Sills for Ease of Loading
- Cylinder Keyed Security Lock and Magnetic Snap-In Gasket on Each Door
- Full Length, Extra Large, Non-Corrosive, Fin Evaporator Coil Provides Uniform Air Flow Distribution To Maintain Constant Keg Temperature and Quick Uniform Recovery
- Continuously Cooled 3" Diameter Beer Column with Dual Stainless Steel Lever Faucets (only for KC50), CO<sub>2</sub> Pressure Relief Distributor and Keg Line Tubing with Clamps
- Easily Removable Stainless Steel Drip Tray with Convenient Front Mounted Cleanout Drainage Hose
- Easily Accessible and Serviceable Slide-Out Condensing Unit
- Incandescent Interior Lighting
- Readily Removable Front, Rear and Side Venting Louvered Grills Allow Greater Condenser Air Flow for Tight Fit Installations
- Automatic, Energy Saving, Non-Electric Condensate Disposal
- High Density, Non-CFC Polyurethane Foamed-in-Place Insulation

### Options & Accessories

- 6" Adjustable Legs
- 4" Locking Casters
- Remote -R
- Stainless Steel Interior for NSF 7 - approved for open food
- Shallow Depth
- SS Models - Stainless Steel Exterior, Galvanized Steel Interior
- Electric Condensate Shelves and Pilasters
- Multiple Faucet Beer Columns
- Condensing Unit on the Right



Approval: \_\_\_\_\_



A Division of National Refrigeration & A/C Products, Inc.  
 539 Dunksferry Road Bensalem, PA 19020  
 (800) 523-7138 Fax: (215) 244-9579  
 www.continentalrefrigerator.com

Printed in U.S.A  
 March, 2009

Project Name: \_\_\_\_\_ Model Specified: \_\_\_\_\_  
 Location: \_\_\_\_\_ Item No. \_\_\_\_\_ Quantity: \_\_\_\_\_

**SPECIFICATIONS**

**DIMENSIONAL DATA**

	<b>KC50</b>	<b>KC59</b>	<b>KC69</b>	<b>KC79</b>	<b>KC90</b>
Net Capacity (cu. ft.)	16	22	26	28	35
Barrel Capacity (# of Barrel Type Kegs)	—	2	3	4	4
Straight Wall Capacity (# of Straight Wall Kegs)	2	3	3	4	5
Width, Overall (in.)	50	59	69	79	90
Depth, Overall, (in.)	27	27	27	27	27
Height, Overall (in.) (Not Incl. 12" Towers)	36 <sup>3</sup> / <sub>4</sub>	36 <sup>3</sup> / <sub>4</sub>	36 <sup>3</sup> / <sub>4</sub>	36 <sup>3</sup> / <sub>4</sub>	36 <sup>3</sup> / <sub>4</sub>
Number of Doors	2	2	2	3	3
Number of Beer Columns	1	2	2	2	2
Condensing Unit Size (H.P.)	1/3	1/3	1/3	1/3	1/2
Refrigerant	R-134a	R-134a	R-134a	R-134a	R-134a
Cabinet Electrical Specs	115/60/1	115/60/1	115/60/1	115/60/1	115/60/1
Total Amps	9.6	9.6	10.3	10.3	13.0
Power Supply Cord (10 ft.)	yes	yes	yes	yes	yes
Shipping Weight (lbs.)	355	385	415	455	505
Shipping Height (in.)	46	46	46	46	46
Shipping Length (in.)	58	65	78	88	109
Shipping Depth (in.)	42	42	42	42	42

**\*\*NOTE:** A minimum clearance of 3" on each side, front and rear of cabinet is required for optimum performance.

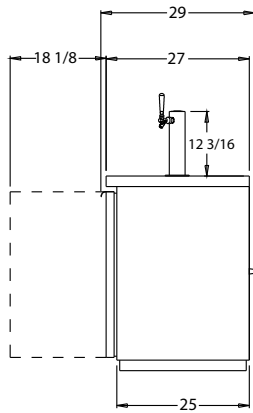

**KC50,59,69,79 & 90  
SIDE VIEW**

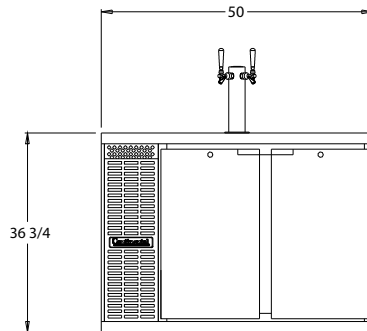

**KC50 FRONT VIEW**

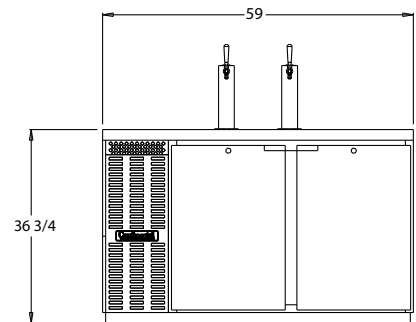

**KC59 FRONT VIEW**

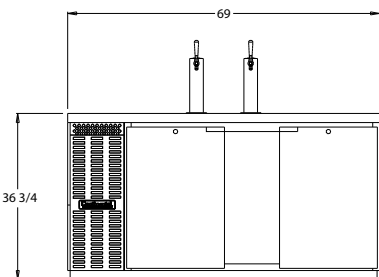

**KC69 FRONT VIEW**

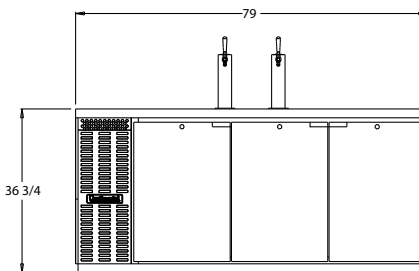

**KC79 FRONT VIEW**

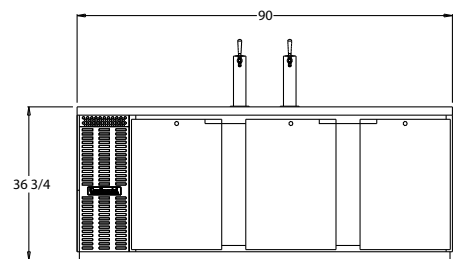

**KC90 FRONT VIEW**