



NOR-LAKE, INCORPORATED
727 Second Street
Hudson, Wisconsin 54016

800-955-5253
715-386-2323
866-961-5253 Parts
800-388-5253 Service
715-386-6149 FAX
www.norlake.com

KOLD LOCKER™ WALK-INS



Kold Locker™ models available with self-contained Capsule Pak™ or remote refrigeration systems.

Standard Model Coolers and Freezers In Stock for SAME DAY SHIPMENT

STANDARD FEATURES

- STANDARD MODELS SHIP THE SAME DAY*
- Cooler or freezer models
- Sizes from 3'6" x 6' to 10' x 14'
- Three heights: 6'7" & 7'7" with floor; 7'4" floorless
- Indoor or outdoor models
- Two temperatures: +35°F, -10°F
- Capsule Pak™ refrigeration system (ceiling or wall mount) (ordered separately)
- Air-cooled condensing unit (wall mount – 10 day ship)
- Automatic condensate vaporizer. No drain line required on indoor units
- Time clock or electronic control provided for automatic defrost on both coolers and freezers
- 26 gauge corrosion resistant stucco embossed coated steel on all surfaces except interior floor
- Smooth aluminum interior floor (on models with floor)
- Floorless models supplied with NSF listed vinyl sealers
- Full 4" thick panels foamed-in-place with EPA-compliant polyurethane insulation
- 26" wide, self-closing door
- Heavy duty adjustable cam-lift hinges
- Spring actuated door closer
- Deadbolt locking handle with independent key/padlock feature and inside safety release
- Magnetic gasket
- Digital thermometer and light switch
- Floor double sweep gasket
- Perimeter door heater wire
- High output low profile LED light positioned above the door to prevent interference with shelving or product
- NSF, UL flame spread 25 or less on all foam cores; UL and CSA electrical listing on door sections ****
- UL, C-UL listing on complete Capsule Pak™ refrigeration systems ***
- City of Houston listed

- California State listed
- CN UL flame spread listed
- DOE compliant
- Oregon State listed
- USDA accepted
- 15 year panel warranty
- 18 months parts & labor warranty

INDOOR MODELS:

- Hot gas condensate vaporizer available on many models

OUTDOOR MODELS:

- White membrane roof and trim
- Refrigeration hood
- -20°F ambient controls

OPTIONAL FEATURES**

- U-shaped shelving system
- Floor tread plate kit
- Exterior ramp
- Condensing unit air deflector kit
- Door hood (outdoor models)
- Heater kit for outdoor use where ambient conditions may go below 32°F
- Leak detector/alarm (may be a requirement in some areas)
- Three phase electrical
- Remote Capsule Pak™ refrigeration systems
- Heights: 8'7" with floor, 8'4" without floor
- Electric vaporizer
- Five year compressor warranty

* Some models ship in 5 or 10 days

** Most options are available two weeks from receipt of order. Please contact us for specific questions.

*** C-UL is Underwriters Laboratories Safety Certification Mark which indicates that UL has tested the equipment to applicable CSA Standards.

**** UL Sanitation is Underwriters Laboratories Sanitation Mark which indicates that UL has tested the equipment to applicable NSF Standards.

KOLD LOCKER™ WALK-INS

KOLD LOCKER™ WALK-INS

WALK-IN SPECIFICATIONS

Kold Locker™ walk-ins are built of modular panels, and are insulated with foamed-in-place EPA-compliant polyurethane insulation. Each panel is designed to ensure ease of installation, long term reliability and high insulating efficiency.

A. All panels are manufactured with male and female mating rails to ensure proper alignment during installation. The polyurethane insulation wraps around the return bend metal seams on both section to create a lightweight panel of exceptional strength and durability. All panels are a full four (4) inches thick and provide a superior insulating value.

B. The foamed-in-place cam locking fasteners ensure an airtight seal for maximum energy efficiency.

C. Kold Locker™ panel gaskets located around the outer perimeter of the panel are continuous, without cuts or breaks at corners. The Nor-Lake patented gasket design provides a foamed-in-place gasket as an integral part of the panel. Gaskets cannot fall off or pull off during shipment or installation.

D. Panels lock together tightly to assure an energy efficient walk-in.

E. Edge caps for ends of floor and ceiling panels are foamed-

in-place rather than overlapped or mechanically fastened. Edge caps cannot come loose, and they stay in place through the life of the walk-in.

F. Panel Finishes: Interior and exterior panels are fabricated with 26 gauge corrosion resistant stucco embossed coated steel. Models supplied with a floor will include a smooth aluminum interior floor surface.

G. Insulation: Panels are four (4) inches thick, metal clad and foamed-in-place with HFO polyurethane insulation which is HFC free.

The R-values for 4" HFO panels are:

Cooler:

Walls/Ceilings R-value 25

Doors R-value 25

Freezer:

Walls/Ceilings R-value 32

Doors R-value 32

Floors R-value 28

Mini Kold Locker™ Walk-ins

3'6" x 6'0" x 6'7" and 3'6" x 7'0" x 6'7"

Similar floor space as 3 door reach-in but with 20%-30% more capacity. Modular, easy to get into existing building, through doors and hallways.

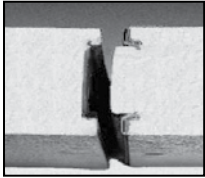

A.

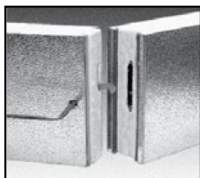

B.

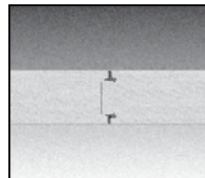

C.

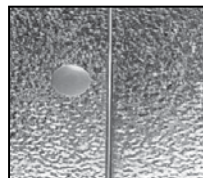

D.

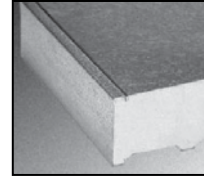

E.

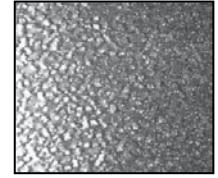

F.

KOLD LOCKER™ WALK-IN AVAILABLE SIZES

The 45 Series is available in one size which is 4' wide x 5' long x 6'-0" high. This model is supplied with a walk-in floor. This series ships in 5 days.

The Standard Series of Kold Locker™ walk-ins are all 6'-7" high and are all supplied with a floor. The sizes available are as follows: 4' wide x 6' long, 6' wide x 6' long, 6' wide x 8' long, 6' wide x 10' long, 6' wide x 12' long, 8' wide x 8' long, and 8' wide x 10' long.

The 77 Series of Kold Locker™ walk-ins are all 7'-7" high and are all supplied with a floor. The sizes available are as follows: 6' wide x 6' long, 6' wide x 8' long, 6' wide x 10' long, 6' wide x 12' long, 8' wide x 8' long, and 8' wide x 10' long.

The 74 Series of Kold Locker™ walk-ins are all 7'-3 5/8" high and are all supplied without a floor. Wall panels are installed on top of NSF listed vinyl sealers provided. The sizes available are as follows: 6' wide x 6' long, 6' wide x 8' long, 6' wide x 10' long, 6' wide x 12' long, 8' wide x 8' long, and 8' wide x 10' long.

OUTDOOR MODELS

All Kold Locker™ walk-ins installed outdoors include a weather protection kit consisting of: One piece, 35 mill, white membrane roof material which requires no seaming or gluing to the top of the Kold Locker™ walk-in ceiling panels.

Metal trim for flashing the membrane roof material to the side of the Kold Locker™ walk-in wall panels is included.

Trim is secured to the Kold-Locker™ wall panels with self-drilling and self-tapping TEK screws. In applications where the Kold Locker™ walk-in is installed next to a building, the trim can be used to secure the turned up membrane roof material to the building wall, with fasteners supplied. Door rain hoods are an option and should be included on installations where the door panels are exposed to the outdoor weather.

DOOR

Door sections manufactured at Nor-Lake are factory tested to assure proper fit, performance and alignment. All doors feature a stepped profile design that serves as a barrier to air flow which results in an energy efficient door system. Door sections are 4" thick, metal clad and foamed-in-place with EPA-compliant polyurethane insulation.

Each Kold Locker™ walk-in compartment is equipped with a 26" wide door opening. The height of the door opening varies with the series of Kold Locker™ walk-in ordered. The 45 Series has a 59" high door, the Standard Series (6'7" high) has a 66" high door opening and the 74 and 77 Series Kold Locker™ walk-ins have a 78" high door opening. The door is self-closing, flush mounted, infitting and constructed to incorporate heavy duty, molded ABS breaker which is permanently foamed-in-place.

Doors are available with right or left side hinges and include two field adjustable cam-lift hinges with locking set screw, top hinge spring loaded, spring actuated door closer, NL 9800 deadbolt locking handle with independent key/padlock feature and inside safety release. The doors are pre-hung in a four foot wide frame panel which is equipped with replaceable perimeter heater wire, magnetic stainless steel trim, digital thermometer, vapor proof LED light fixture and switch with exterior pilot indicator light.

The door section is completely pre-wired within concealed conduit inside the door frame panel. 120/60/1 electrical is field wired to a junction box which is surface mounted next to the interior frame above the vapor proof LED light fixture.

Hinges and door handle are mounted to 1/2" synthetic insulated tapping plates. Each door section is complete with a fiberglass reinforced plastic heated threshold.

DOOR OPENING SIZE		
W	H	MODEL
26"	59"	45 Series
26"	66"	STD Series
26"	78"	74 Series
26"	78"	77 Series

These doors are designed and certified for use in walk-in cooler applications.

DOOR MODEL NUMBER	ENERGY CONSUMPTION (KWH/DAY)	DOOR SURFACE AREA (SQ. FT.)	ELECTRICAL	WATTS	AMPS
KL26X59	2.30	12.00	120/60/1	97.73	0.81
KL26X66	2.37	13.40	120/60/1	100.80	0.84
KL26X78	2.49	15.80	120/60/1	106.07	0.88



Deadbolt-locking handle



Spring actuated door closer



LED Light Fixture

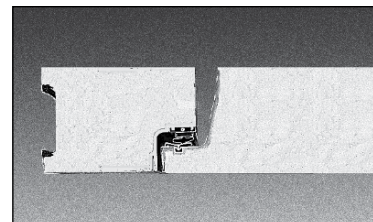

Doors feature a stepped profile design



Digital Thermometer/ Light Switch

These doors are designed and certified for use in walk-in freezer applications.

DOOR MODEL NUMBER	ENERGY CONSUMPTION (KWH/DAY)	DOOR SURFACE AREA (SQ. FT.)	ELECTRICAL	WATTS	AMPS
KL26X59	6.48	12.00	120/60/1	189.69	1.58
KL26X66	6.68	13.40	120/60/1	196.07	1.63
KL26X78	7.01	15.80	120/60/1	207.07	1.73

KOLD LOCKER™ WALK-INS

FLOOR CONSTRUCTION

Floor panels (when supplied) are similar in construction to the wall panels except they are made to withstand uniformly distributed floor loads of up to 800 pounds per square foot. The interior floor metal is smooth aluminum.

The 74 Series, floorless models, are supplied with a patented vinyl floor sealer to stop conductivity at floor level. This unique sealer sits flat on existing floors and fits tightly against the interior/external wall panels. The walk-in wall panel is supported on the shoulder of the sealer so the foam edge is free of compressing weight. The vinyl floor sealer is NSF listed.

SHELVING KITS

Shelving kits specifically designed for each Kold Locker™ walk-in configuration are offered as an optional extra. These kits are shipped with the Kold Locker™ walk-in and Capsule Pak™ refrigeration system so that all necessary components are at your location promptly when you need them. The shelving sets are coded to correspond to the Kold Locker™ walk-in configuration ordered and are offered in either three or four tier.

SHELVING SYSTEM TYPES

A. Green Kote™ Shelving: Electrostatically applied green baked epoxy over zinc steel and brite basic wire. Thickness: 2-3 mill. 15 year guarantee against corrosion.

B. Nor-Lake Standard Chrome Kote™ Shelving: Plated quality wire and steel. Surface nickel chrome plated.

Select the shelving FINISH of your choice. Shelving posts are engineered for maximum strength. Shelves are adjustable on 2" centers. All shelves are NSF listed and are zinc coated with a heavy layer of Protoxy for a maximum life span under humid storage conditions. Special clips are utilized to gain the maximum square footage of storage space for each Kold Locker™ model. 14", 18" and 24" wide shelves are used as required for maximum storage capacity in each set. This wire shelving is ideal for storage of all refrigerated or frozen products.

SHELVES

Shelves to have #9 (.148") ga. crosswires spaced 3/4" on centers with crossbraces 1/4" (.192") minimum of 4-3/4" on center.

Shelf Frames: Channel to be 9/16" x 1" x .075" thick.

Shelf Collars: A round tapered 1-5/16" high steel collar to be welded at each corner.

POSTS

Posts to be .062" thick 1" O.D. round tubing notched every 2" on each corner of the post.

POST LEVELERS

Installed on the bottom of each post is nylon housing for a steel leveler 3/8"-16 x 1-3/4".



Floorless models are supplied with a patented vinyl floor sealer



Shelving system types include Green Kote™ and Chrome Kote™

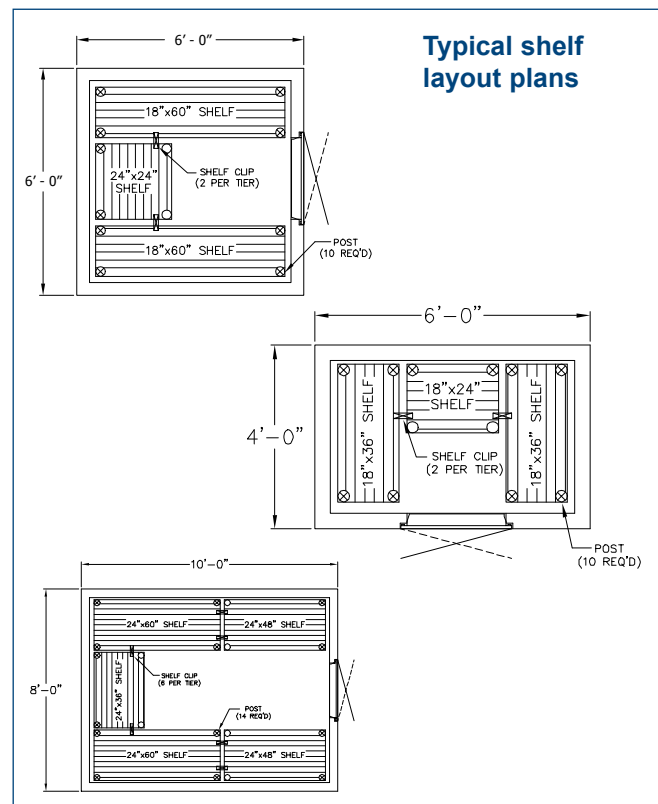

STANDARD CAPSULE PAK™ REFRIGERATION SYSTEMS



INDOOR CEILING MOUNT



WALL MOUNT

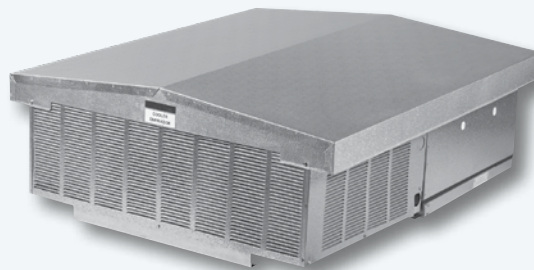

OUTDOOR CEILING MOUNT

Capsule Pak™ refrigeration systems are an ideal solution for simple and rapid installation. Each system consists of a condensing unit and evaporator coil together in one housing. All models are factory assembled, wired, charged, tested and fully equipped for fast and easy insertion into a factory prepared walk-in opening.

With Capsule Pak™ systems, installation costs are greatly reduced because there's no piping or other components requiring field installation. Certain models also come with a power cord so the unit can be plugged in.

STANDARD FEATURES

- Available for coolers or freezers
- Indoor or outdoor models
- Two temperatures: +35°F and -10°F
- Ceiling or wall mount
- Air cooled condensing unit
- Automatic condensate vaporizer. No drain lines required on indoor units
- Time clock or electronic control provided for automatic defrost on both coolers and freezers
- UL and C-UL electrical listing on complete Capsule Pak™ refrigeration systems**
- -20°F ambient controls (outdoor models)
- 18 months parts and labor warranty

OPTIONAL FEATURES*

- Condensing unit air deflector kit
- Heater kit for outdoor use where ambient conditions may go below 32°F
- Three phase electrical
- Remote Capsule Pak™ refrigeration system
- Electric condensate vaporizer
- 5 year compressor warranty

* Most options are available two weeks from receipt of order. Please contact us for specific questions.

** C-UL is Underwriters Laboratories Safety Certification Mark which indicates that UL has tested the equipment to applicable CSA Standards.

KOLD LOCKER™ WALK-INS

CAPSULE PAK™ REFRIGERATION SYSTEM SPECIFICATION

Capsule Pak™ refrigeration systems consist of a unitized system which is factory assembled, wired, charged, tested and fully equipped for insertion into a factory prepared walk-in opening. The Capsule Pak™ system has a flush coil which keeps all components outside the walk-in storage area, allowing more storage inside. Models are available for wall or ceiling mounting for use on indoor or outdoor installations. Models are available for interior compartment design temperatures of +35°F and -10°F. Installation is fast and easy. No plumbing required on indoor units.

The Capsule Pak™ evaporator section is an integral factory assembled component of the complete Capsule Pak™ refrigeration system. The evaporator section is designed to be located entirely outside the walk-in with no intrusions into the refrigerated space. The evaporator enclosure is constructed utilizing foamed-in-place polyurethane insulation and equipped with a removable, gasketed access cover. Capsule Pak™ models use high efficiency EC evaporator fan motors to circulate air throughout the walk-in.

All indoor Capsule Pak™ models are equipped with a discharge gas condensate vaporizer or optional electric condensate vaporizer. All outdoor Capsule Pak™ models are equipped with low ambient controls consisting of crankcase heater, flooded condenser head pressure control and pump down cycle.

All standard Capsule Pak™ refrigeration systems are stocked for same day shipment.

All standard Capsule Pak™ refrigeration systems are UL and C-UL listed.

Note: Allow minimum of 6" clearance above the Capsule Pak™ system for installation. Consideration should be given to accessibility for service and free condenser air flow. Consult factory with installation questions.



CEILING MOUNT CAPSULE PAK™ SYSTEM

Ceiling Mount Capsule Pak™ systems are conveniently located on top of the walk-in to maximize available floor space. Available in indoor and outdoor models for single or dual walk-in compartments. Ceiling mount systems are available for same day shipment.



WALL MOUNT CAPSULE PAK™ SYSTEM

The Wall Mount Capsule Pak™ System provides easy access for service and installation where there is not enough room for a ceiling mounted application. Available in indoor models for single or dual walk-in compartments. Wall Mount Systems are available to ship in ten days.

FLOOR PLAN LAYOUTS FOR SINGLE ROOM COOLERS OR FREEZERS

Model numbers indicate the door location on the standard Kold Locker layouts

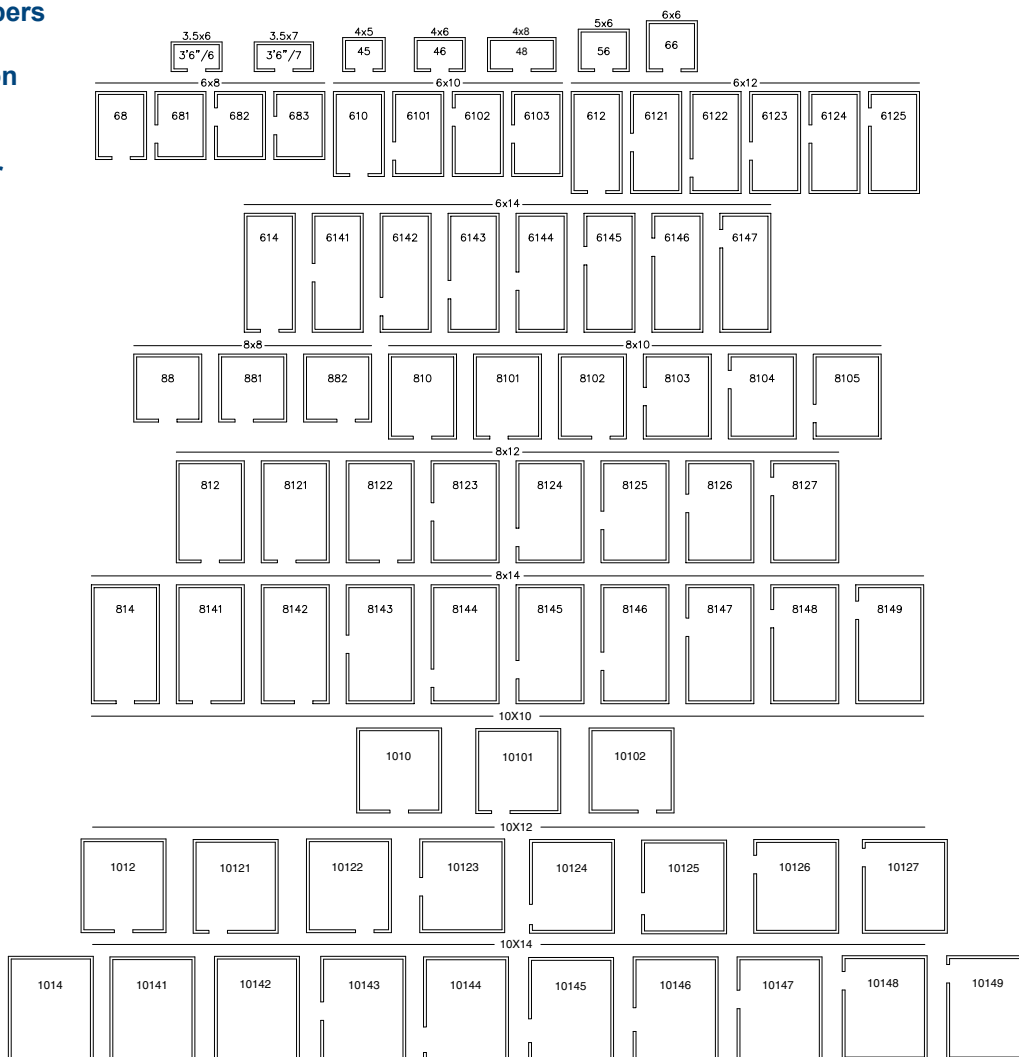

PHYSICAL SPECIFICATIONS

6'7" HIGH		7'4" HIGH & 7'7" HIGH	
UNIT INTERIOR	CAPACITY CU. FT.	UNIT INTERIOR	CAPACITY CU. FT.
KL45 (6'0" High)	77	KL7745	100
KL46 (4' x 6')	105	KL7746	123
KL56 (5' x 6')	137	KL7756	159
KL66 (6' x 6')	168	KL7766	196
KL68 (6' x 8')	231	KL7768	270
KL610 (6' x 10')	295	KL77610	344
KL612 (6' x 12')	357	KL77612	418
KL614 (6' x 14')	420	KL77614	490
KL88 (8' x 8')	318	KL7788	372
KL810 (8' x 10')	404	KL77810	473
KL812 (8' x 12')	490	KL77812	574
KL814 (8' x 14')	578	KL77814	675
KL1010 (10' x 10')	515	KL771010	602
KL1012 (10' x 12')	625	KL771012	731
KL1014 (10' x 14')	736	KL771014	860

KOLD LOCKER™ WALK-INS

MATCHING CAPSULE PAK™ REFRIGERATION SYSTEMS

KOLD LOCKER™ MODEL SYSTEM MOUNT	-10°F CEILING MOUNT	+38°F to +35°F CEILING MOUNT	+38°F to +35°F WALL MOUNT	-10°F WALL MOUNT
6'0" HIGH WITH FLOOR				
KL45	CPF060DC-A	CPB050DC-A	CPB050DW	N/A
KOD45	CPF060DCO-A	CPB050DCO-A	N/A	N/A
6'7" HIGH WITH FLOOR				
KL366	CPF050DC-A	CPB050DC-A	CPB050DW	N/A
KL367	CPF050DC-A	CPB050DC-A	CPB050DW	N/A
KL46	CPF060DC-A	CPB050DC-A	CPB050DW	N/A
KL56	CPF075DC-B	CPB050DC-A	CPB050DW	N/A
KL66	CPF075DC-B	CPB050DC-A	CPB050DW	N/A
KL68	CPF100DC-A	CPB050DC-A	CPB050DW	CPF100DW
KL610	CPF100DC-A	CPB050DC-A	CPB050DW	CPF100DW
KL612	CPF150DC-A	CPB075DC-A	N/A	N/A
KL614	N/A	CPB100DC-A	N/A	N/A
KL88	CPF100DC-A	CPB050DC-A	CPB050DW	CPF100DW
KL810	CPF150DC-A	CPB075DC-A	CPB075DW	CPF150DW
KL812	CPF150DC-A	CPB100DC-A	N/A	N/A
KL814	CPF151DC-A	CPB100DC-A	N/A	N/A
KL1010	CPF151DC-A	CPB100DC-A	N/A	N/A
KL1012	CPF151DC-A	CPB100DC-A	N/A	N/A
KL1014	CPF151DC-A	CPB100DC-A	N/A	N/A
6'7" HIGH WITH FLOOR OUTDOOR				
KOD46	CPF075DCO-A	CPB050DCO-A	N/A	N/A
KOD56	CPF075DCO-A	CPB050DCO-A	N/A	N/A
KOD66	CPF100DCO-A	CPB075DCO-A	N/A	N/A
KOD68	CPF100DCO-A	CPB075DCO-A	N/A	N/A
KOD610	CPF150DCO-A	CPB075DCO-A	N/A	N/A
KOD612	CPF150DCO-A	CPB075DCO-A	N/A	N/A
KOD614	N/A	CPB100DCO-A	N/A	N/A
KOD88	CPF150DCO-A	CPB075DCO-A	N/A	N/A
KOD810	CPF150DCO-A	CPB075DCO-A	N/A	N/A
KOD812	CPF151DCO-A	CPB100DCO-A	N/A	N/A
KOD814	CPF151DCO-A	CPB100DCO-A	N/A	N/A
KOD1010	CPF151DCO-A	CPB100DCO-A	N/A	N/A
KOD1012	CPF151DCO-A	CPB100DCO-A	N/A	N/A
KOD1014	CPF200DCO-A	CPB100DCO-A	N/A	N/A
7' 4" HIGH LESS FLOOR - INDOOR ONLY				
KL7446	N/A	CPB050DC-A	CPB050DW	N/A
KL7456	N/A	CPB050DC-A	CPB050DW	N/A
KL7466	N/A	CPB050DC-A	CPB050DW	N/A
KL7468	N/A	CPB075DC-A	CPB075DW	N/A
KL74610	N/A	CPB075DC-A	CPB075DW	N/A
KL74612	N/A	CPB075DC-A	N/A	N/A
KL74614	N/A	CPB100DC-A	N/A	N/A
KL7488	N/A	CPB075DC-A	CPB075DW	N/A
KL74810	N/A	CPB075DC-A	CPB075DW	N/A
KL74812	N/A	CPB100DC-A	N/A	N/A
KL74814	N/A	CPB100DC-A	N/A	N/A
KL741010	N/A	CPB100DC-A	N/A	N/A
KL741012	N/A	CPB100DC-A	N/A	N/A
KL741014	N/A	CPB100DC-A	N/A	N/A

MATCHING CAPSULE PAK™ REFRIGERATION SYSTEMS

KOLD LOCKER™ MODEL SYSTEM MOUNT	-10°F CEILING MOUNT	+38°F to +35°F CEILING MOUNT	+38°F to +35°F WALL MOUNT	-10°F WALL MOUNT
7' 7" HIGH WITH FLOOR				
KL7746	CPF075DC-B	CPB050DC-A	CPB050DW	N/A
KL7748	CPF100DC-A	CPB050DC-A	N/A	N/A
KL7756	CPF100DC-A	CPB050DC-A	CPB050DW	CPF100DW
KL7766	CPF100DC-A	CPB050DC-A	CPB050DW	CPF100DW
KL7768	CPF100DC-A	CPB050DC-A	CPB050DW	CPF100DW
KL77610	CPF150DC-A	CPB075DC-A	CPB075DW	CPF150DW
KL77612	CPF150DC-A	CPB075DC-A	N/A	N/A
KL77614	N/A	CPB100DC-A	N/A	N/A
KL7788	CPF150DC-A	CPB075DC-A	CPB075DW	CPF150DW
KL77810	CPF150DC-A	CPB075DC-A	CPB075DW	CPF150DW
KL77812	CPF150DC-A	CPB100DC-A	N/A	N/A
KL77814	CPF151DC-A	CPB100DC-A	N/A	N/A
KL771010	CPF151DC-A	CPB100DC-A	N/A	N/A
KL771012	CPF151DC-A	CPB100DC-A	N/A	N/A
KL771014	CPF151DC-A	CPB100DC-A	N/A	N/A
7' 7" HIGH WITH FLOOR OUTDOOR				
KOD7746	CPF075DCO-A	CPB075DCO-A	N/A	N/A
KOD7756	CPF100DCO-A	CPB075DCO-A	N/A	N/A
KOD7766	CPF100DCO-A	CPB075DCO-A	N/A	N/A
KOD7768	CPF150DCO-A	CPB075DCO-A	N/A	N/A
KOD77610	CPF150DCO-A	CPB075DCO-A	N/A	N/A
KOD77612	CPF150DCO-A	CPB075DCO-A	N/A	N/A
KOD77614	N/A	CPB100DCO-A	N/A	N/A
KOD7788	CPF150DCO-A	CPB075DCO-A	N/A	N/A
KOD77810	CPF151DCO-A	CPB075DCO-A	N/A	N/A
KOD77812	CPF151DCO-A	CPB100DCO-A	N/A	N/A
KO77B814	CPF200DCO-A	CPB100DCO-A	N/A	N/A
KOD771010	CPF151DCO-A	CPB100DCO-A	N/A	N/A
KOD771012	CPF200DCO-A	CPB100DCO-A	N/A	N/A
KOD771014	CPF200DCO-A	CPB100DCO-A	N/A	N/A
8'4" HIGH LESS FLOOR				
KL8466	N/A	CPB050DC-A	N/A	N/A
KL8468	N/A	CPB075DC-A	N/A	N/A
KL84610	N/A	CPB075DC-A	N/A	N/A
KL84612	N/A	CPB075DC-A	N/A	N/A
KL84614	N/A	CPB100DC-A	N/A	N/A
KL8488	N/A	CPB075DC-A	N/A	N/A
KL84810	N/A	CPB075DC-A	N/A	N/A
KL84812	N/A	CPB100DC-A	N/A	N/A
KL84814	N/A	CPB100DC-A	N/A	N/A
8'7" HIGH WITH FLOOR				
KL8766	CPF100DC-A	CPB050DC-A	N/A	N/A
KL8768	CPF100DC-A	CPB050DC-A	N/A	N/A
KL87610	CPF150DC-A	CPB075DC-A	N/A	N/A
KL87612	CPF150DC-A	CPB075DC-A	N/A	N/A
KL87614	N/A	CPB100DC-A	N/A	N/A
KL8788	CPF150DC-A	CPB075DC-A	N/A	N/A
KL87810	CPF150DC-A	CPB075DC-A	N/A	N/A
KL87812	N/A	CPB100DC-A	N/A	N/A
KL87814	N/A	CPB100DC-A	N/A	N/A
8'7" HIGH WITH FLOOR OUTDOOR				
KOD8766	CPF100DCO-A	CPB075DCO-A	N/A	N/A
KOD8768	CPF150DCO-A	CPB075DCO-A	N/A	N/A
KOD87610	CPF150DCO-A	CPB075DCO-A	N/A	N/A
KOD87612	CPF150DCO-A	CPB075DCO-A	N/A	N/A
KOD87614	N/A	CPB100DCO-A	N/A	N/A
KOD8788	CPF150DCO-A	CPB075DCO-A	N/A	N/A
KOD87810	CPF151DCO-A	CPB075DCO-A	N/A	N/A
KOD87812	N/A	CPB100DCO-A	N/A	N/A
KOD87814	N/A	CPB100DCO-A	N/A	N/A

KOLD LOCKER™ WALK-INS

CAPSULE PAK™ PHYSICAL SPECIFICATIONS

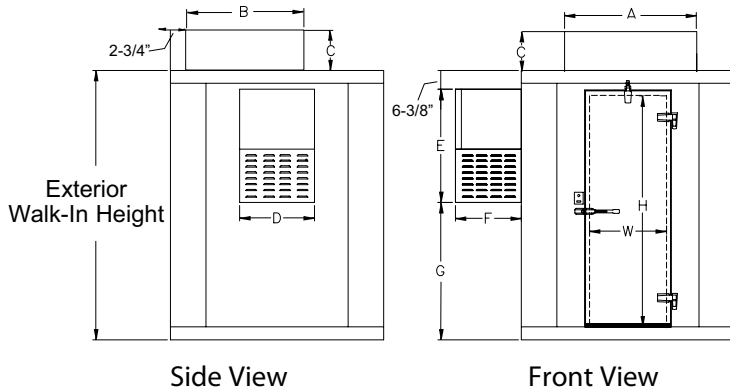

Door Opening Size

W	H	Model
26"	59"	45 Series
26"	66"	STD Series
26"	78"	74 Series
26"	78"	77 Series

CEILING MOUNT MODEL NO.	"A" DIMENSION	"B" DIMENSION	"C" DIMENSION
CPB050DC-A	29"	44-1/2"	14-3/4"
CPB075DC-A	37"	44-1/2"	14-3/4"
CPB100DC-A	34-1/2"	59"	21-1/4"
CPB150DC-A	34-1/2"	59"	21-1/4"
CPF050DC-A	28"	44-1/2"	14-3/4"
CPF060DC-A	37"	44-1/2"	14-3/4"
CPF075DC-B	37"	44-1/2"	14-3/4"
CPF075DC-B	54"	24-1/4"	14-3/4"
CPF100DC-A	34-1/2"	59"	21-1/4"
CPF150DC-A	34-1/2"	59"	21-1/4"
CPF151DC-A	34-1/2"	59"	21-1/4"
CPF200DC-A	34-1/2"	59"	21-1/4"
CPB050DCO-A	32"	44-1/2"	16-1/8"
CPB075DCO-A	43"	48-1/4"	16-1/8"
CPB100DCO-A	40-1/2"	59"	22-7/8"
CFB150DCO-A	40-1/2"	59"	22-7/8"
CPF060DCO-A	43"	48-1/4"	16-1/8"
CPF075DCO-A	43"	48-1/4"	16-1/8"
CPF100DCO-A	40-1/2"	59"	22-7/8"
CPF150DCO-A	40-1/2"	59"	22-7/8"
CPF151DCO-A	40-1/2"	59"	22-7/8"
CPF200DCO-A	40-1/2"	59"	22-7/8"

WALL MOUNT MODEL NO.	"D" DIMENSION	"E" DIMENSION	"F" DIMENSION	"G" DIMENSION			
				EXTERIOR WALK-IN HEIGHT			
				6'	6'7"	7'4"	7'7"
CPB050DW	25-1/4"	38"	22-1/4"	27-3/8"	34-3/8"	43"	46-3/8"
CPB075DW	44-1/8"	45"	30"	N/A	27-5/8"	36-1/4"	39-5/8"
CPF100DW	44-1/8"	45"	30"	N/A	27-5/8"	36-1/4"	39-5/8"
CPF150DW	44-1/8"	45"	30"	N/A	27-5/8"	36-1/4"	39-5/8"

NOTE:

- Consideration must be given to accessibility for service & free condenser air flow. Consult factory with installation questions.
- +90°F ambient or less and 50% RH
- Subject to change without notice

CAPSULE PAK™ ELECTRICAL DATA (ALL SYSTEMS USE R-404A REFRIGERANT)

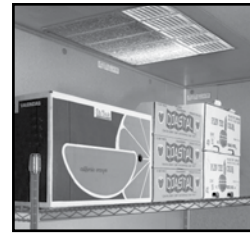
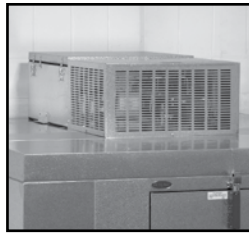
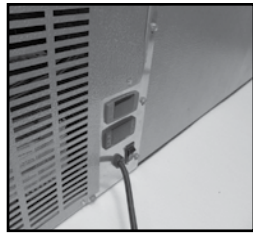

MODEL	ELECTRICAL	TOTAL SYSTEM AMPS	TOTAL DEFROST AMPS	MCA	NEMA PLUG OR FUSE SIZE	CORD & PLUG SYSTEM
CEILING MOUNT						
CPB050DC-A	115/60/1	14.3	N/A	N/A	5-20P	X
CPB075DC-A	208-230/60/1	7.7	N/A	N/A	6-20P	X
CPB100DC-A	208-230/60/1	7.7	N/A	N/A	6.15P	X
CPB150DC-A	208-230/60/1	10.4	N/A	15.4	25	
CPF050DC-A	115/60/1	11.6	5.84	13.5	20	
CPF060DC-A	208-230/60/1	7.7	N/A	N/A	6.20P	X
CPF075DC-B	208-230/60/1	8.1	N/A	9.7	6-15P	X
CPF075DC-B	208-230/60/1	8.1	N/A	9.7	6-15P	X
CPF100DC-A	208-230/60/1	7.5	N/A	N/A	6-15P	X
CPF150DC-A	208-230/60/1	12.0	12.2	13.9	20	
CPF151DC-A	208-230/60/1	10.0	10.2	13.4	20	
CPF200DC-A	208-230/60/1	15.7	11.4	17.7	20	
CPB050DCO-A	115/60/1	12.0	N/A	15.3	20	
CPB075DCO-A	208-230/60/1	8.6	N/A	12.0	15	
CPB100DCO-A	208-230/60/1	8.2	N/A	11.2	20	
CFB150DCO-A	208-230/60/1	10.4	N/A	15.8	25	
CPF060DCO-A	208-230/60/1	7.4	7.2	11.4	15	
CPF075DCO-A	208-230/60/1	7.0	6.7	9.65	15	
CPF100DCO-A	208-230/60/1	8.6	8.8	10.3	15	
CPF150DCO-A	208-230/60/1	9.6	10.9	12.0	15	
CPF151DCO-A	208-230/60/1	11.7	8.45	13.95	20	
CPF200DCO-A	208-230/60/1	14.2	10.3	16.4	20	
WALL MOUNT						
CPB050DW	115/60/1	11.2	N/A	N/A	5-20P	X
CPB075DW	208/230-60-1	8.7	N/A	N/A	6-15P	X
CPF100DW	208-230/60/1	11.4	7.1	14.9	20	
CPF150DW	208-230/60/1	11.2	7.1	14.2	20	

KOLD LOCKER™ WALK-INS

REMOTE CAPSULE PAK™ REFRIGERATION SYSTEMS (ALL SYSTEMS USE R-449A REFRIGERANT)

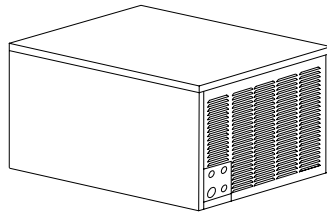
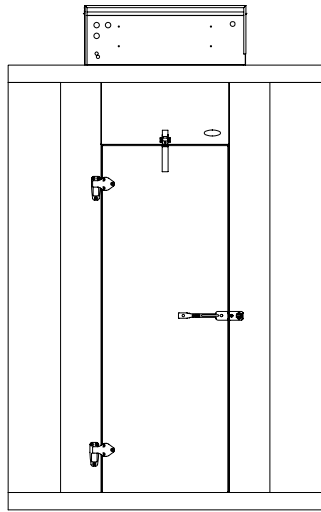

These systems include ambient controls, weather-proof hoods, precharged systems with quick connects for simple field connections to precharged lines of your choice. Consult factory for application, pricing and ship date availability.

MODEL NUMBER	REFRIG. OPENING SIZE	CONDENSING UNIT				
		VOLTAGE	COND. AMPS	MIN. CIRCUIT AMPS	MAX FUSE SIZE	AWEF

CEILING MOUNT 35°F COOLER SYSTEMS

RCPB075JC-A-EV	MEDIUM	208-230/60/1	5.24	7.18	15	3.62
RCPB100JC-A-EV	LARGE	208-230/60/1	7.1	9.8	15	5.01

CEILING MOUNT -10°F FREEZER SYSTEMS

RCPF075JC-A-EV	MEDIUM	208-230/60/1	5.74	7.93	15	N/A
RCPF100JC-A-EV	LARGE	208-230/60/1	6.32	8.43	15	N/A
RCPF150JC-A-EV	LARGE	208-230/60/1	12.4	16.3	20	N/A

EVAPORATOR UNIT				
VOLTAGE	DEFROST AMPS	EVAP AMPS	MIN. CIRCUIT AMPS	MAX FUSE SIZE

230/60/1	N/A	1.1	1.3	15
230/60/1	N/A	1.0	1.3	15

230/60/1	6.7	2.2	6.7	15
230/60/1	8.8	1.2	8.8	15
230/60/1	10.7	1.1	10.7	15

Optional Electric Condensate Vaporizer

Exclusive to Nor-Lake is the Electric Condensate Vaporizer for Remote Capsule Pak™ Systems. This UL and C-UL approved product requires no drain lines on indoor applications, which makes installation fast and easy and allows equipment to be operational in a shorter time frame.

