



BEVERAGE-AIR

Project: _____

AIA#

Item: _____

Location: _____

SIS#

Approved: _____

NC SLANT TOP BUNKERS

NC68HC Novelty Freezers

Hydrocarbon Series

MODELS:

NC68HC-1-W



NC68HC-1-W

**3 Year Parts/Labor Warranty
Additional 2 Year Compressor Warranty**

CABINET CONSTRUCTION

- Exterior is white coated steel
- Interior is white powder coated surface
- Low energy consumption
- LED lighting
- Adjustable thermostat
- Operating temperature of -10°F
- Angle top design with LowE tempered glass lids
- Lids are easily removable with lid lock & keys standard
- Round exterior edges
- Integrated tag molding
- 2" heavy duty casters
- Drain plug for easy cleaning
- 7 Removable baskets, standard

OPTIONS & ACCESSORIES

- 2 Ring Tub

REFRIGERATION SYSTEM

- Refrigeration system uses R290 refrigerant to comply with all environmental concerns

NC68HC Novelty Freezer: Slant Top Bunkers



3779 Champion Blvd., Winston-Salem, NC 27105
1-888-845-9800 Fax: 1-336-245-6453
Beverage-Air.com sales@bevair.com



BEVERAGE-AIR

Slant Top Bunkers - Novelty Freezers

Models: NC68HC-1-W

MODEL	NC68HC-1-W
EXTERNAL DIMENSIONAL DATA	
Width Overall	68 2/7"
Depth Overall	26 2/5"
Height Overall	34 1/5"
Number of Lids	2
Number of Baskets	7
INTERNAL DIMENSIONAL DATA	
NET Capacity (cubic ft.)	21.0
ELECTRICAL DATA	
Full Load Amperes 115/60/1	4
REFRIGERATION DATA	
Horsepower	1/3
WEIGHT DATA	
Gross Weight (Crated lbs)	251 lbs
Height - Crated	35.3"
Width - Crated	69.5"
Depth - Crated	27.7"

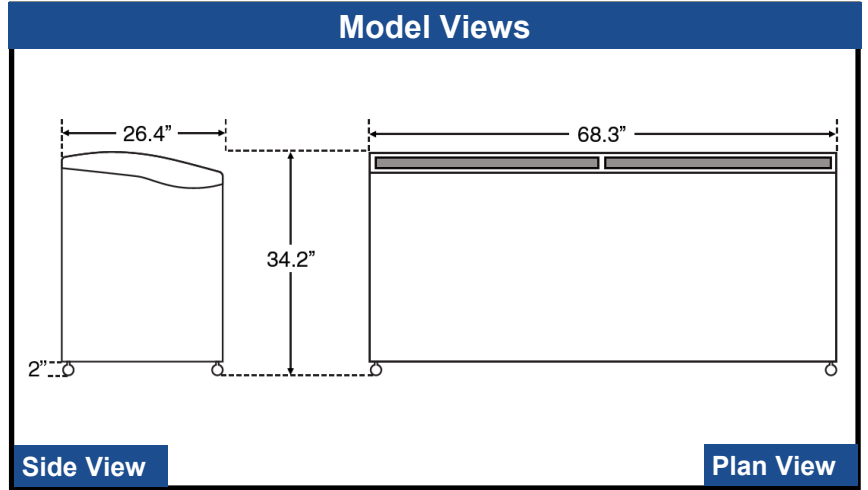

ELECTRICAL CONNECTION



115/60/1
NEMA-5-15P

Units pre-wired at factory and include 8' long cord and plug set.



an Ali Group Company



The Spirit of Excellence

3779 Champion Blvd., Winston-Salem, NC 27105
1-888-845-9800 Fax: 1-336-245-6453
Beverage-Air.com sales@bevair.com