

iT0500 Ice Cube Machine

Models

- IRT0500A
 IDT0500A
 IYT0500A
 IRT0500W
 IDT0500W
 IYT0500W



Indigo NXT Series iT0500 Ice Machine on D570 Bin
*Ice machine and Bin sold separately

Designed for operators who know that ice is critical to their business, the Indigo NXT Series ice machine's preventative diagnostics continually monitor itself for reliable ice production. Improvements in cleanability and programmability make your ice machine easy to own and less expensive to operate.

- **New levels of Performance** - Showcasing an average of 12% lower energy consumption and a 23% reduction in condenser water usage. This translates into lower cost of ownership over the life of your machine.
- **easyTouch® Display** - New icon based touch screen takes the guess work out of owning and operating an ice machine.
- **Programmable Ice Production** - Now its super easy to program your ice machine to be off at certain times of the day to save money with fluctuating electrical rates. Also programmable by daily ice production volume and night time programming.
- **Easy to Clean Food Zone** - Hinge front door swing out for easy access. Removable water-trough, distribution tube, curtain, water probe and water pump for fast and efficient cleaning. Selected components are made with AlphaSan® antimicrobial.
- **Intelligent Diagnostics** - Provides 24 hour preventative maintenance and diagnostic feedback for trouble free operation.
- **Acoustical Ice Sensing Probe** - Unique patented technology allows for reliable operation in challenging water conditions and environments
- **DuraTech® Exterior** - Provides superior corrosion resistant above stainless steel. Innovative clear-coat resists fingerprints and dirt making it easier to keep clean.
- Available **LuminIce® II Virus and Bacteria Inhibitor** - Controls viruses, bacteria, mold and yeast within the food zone to keep the ice machine clean longer. A new sanitation icon lets you know the operational status.
- **Active Sense** - insures consistent ice harvest in all environmental conditions. This software works in conjunction with the acoustical ice sensing probe improving reliability and performance.

Ice Machine Electric

115/60/1 standard
(208-230/60/1 also available)

Minimum circuit ampacity:

Air-cooled: 115v : 11.5, 208-230v : 5.1
Water-cooled: 115v : 10.8

Maximum fuse size:

Air Cooled: 15 amps
Water cooled: 15 amps



Specifications

BTU Per Hour:
3,800 (average),
and 6,000 (peak)

Refrigerant:

R410A CFS - Free
Lowers global warming
by 48%

Operating Limits:

- Ambient Temperature Range: 40 to 110 F (4.4 to 43.3 C)
Water Temperature Range: 40 to 90 F (4.4 to 32.2 C)
- Potable Water Pressure: Min. 20 psi (137.9 kPa)
Max. 80 psi (551.1 kPa)
- Condenser Water Pressure: Min. 20 psi (137.9 kPa)
Max. 276 psi (1902.95 kPa)

Ice Shape

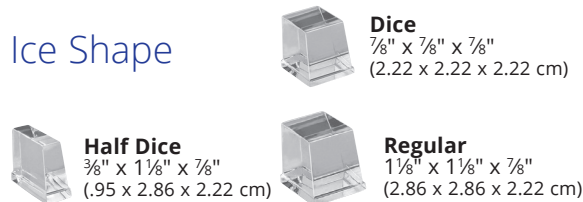

iT0500 on D-570 Storage Bin

- (A) Electrical Entrance (2) Options
- (B) 3/8" (0.95 cm) F.P.T. Water Condenser Inlet (water-cooled units)
- (C) 1/2" (1.27 cm) F.P.T. Water Condenser Outlet (water-cooled units)
- (D) 1/2" (1.27 cm) Auxiliary Base Drain Socket
- (E) 3/8" (0.95 cm) F.P.T. Ice Making Water Inlet
- (F) 1/2" (1.27 cm) F.P.T. Ice Making Water Drain
- (G) 3/4" (1.91 cm) Bin Drain

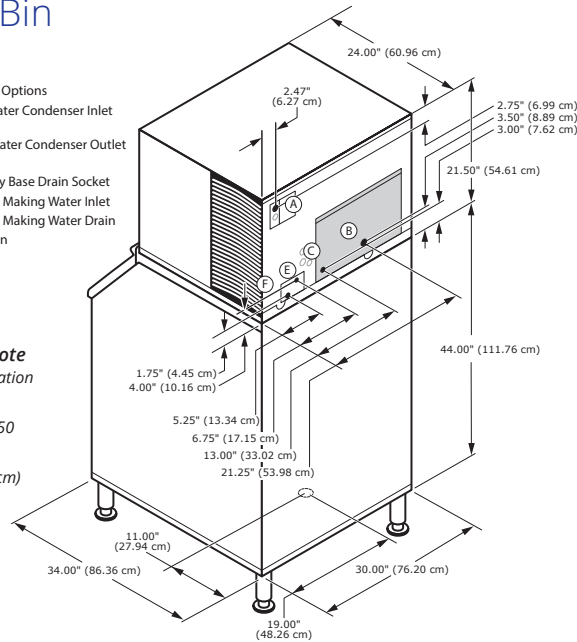

Installation Note

Minimum installation clearance:

Top/side: 8" (30.50 cm)
Back is 5" (12.7 cm)

Space-Saving Design



	iT0500 D-400	iT0500 D-570
Height	59.50" 151.13 cm	71.50" 181.61 cm
Width	30.00" 76.2 cm	30.00" 76.2 cm
Depth	34.00" 86.30 cm	34.00" 86.30 cm
Bin Storage	365 lbs. 165.7 kgs.	543 lbs. 241.1 kgs.

Height includes adjustable bin legs 6.00" to 8.00", (15.24 to 20.32 cm) set at 6.00" (15.24 cm).
Bin capacity is based on 90% of the volume x 33 lbs/ft³ average density of ice.

Specifications

	Model	Ice Shape	Ice Production 24 Hours		Power Usage kWh/100 lbs. @90°Air/70°F 1 Ph	Potable Water Usage/100 lbs. 45.4 kgs. of Ice
			70°Air/ 50°F Water	90°Air/ 70°F Water		
AIR COOLED	IRT0500A	Regular	500 lbs.	386 lbs.	5.04 ★	19 Gal. 71.9 L
			227 kgs	175 kgs		
	IDT0500A	dice	520 lbs.	400 lbs.	5.25 ★	19 Gal. 71.9 L
WATER COOLED	IYT0500A	half-dice	550 lbs.	440 lbs.	4.58 ★	19 Gal. 71.9 L
			249 kgs	200 kgs		
	IRT0500W	Regular	500 lbs.	406 lbs.	4.30	19 Gal. 71.9 L
IDT0500W	dice	500 lbs.	400 lbs.	4.41	19 Gal. 71.9 L	
		227 kgs	181 kgs			
IYT0500W	half-dice	535 lbs.	460 lbs.	3.90	19 Gal. 71.9 L	
		243 kgs.	209 kgs			

* Water-cooled Condenser Water Usage / 100 lbs. /45.4 kgs. Of Ice: 130 gal/ 492 L.
*Water-cooled models are excluded from ENERGY STAR qualification.

Order the ice storage bin separate from the ice machine.
★ ENERGY STAR® 3.0

Accessories

LuminIce® II Virus and Bacteria Inhibitor
controls viruses and bacteria in the ice machine.



External Scoop holder
protect the ice scoop with the NSF approved versatile scoop holder.



Arctic Pure® Water Filters
reduces sediment and chlorine odors for better tasting ice.



iAuCS®
schedules and performs routine ice machine cleaning automatically.



Welbilt reserves the right to make changes to the design or specifications without prior notice.