



SUIM-160 ICE MACHINE

INCLUDE 2 YEAR PARTS + LABOR / 5 YEAR COMPRESSOR WARRANTY

Dimensions

Dimensions (WxDxH)	26" x 27" x 38.1"
Output (lb/24hr)	160 lbs
Bin Capacity	80 lbs
Net Weight	121 lbs
Gross Weight	144 lbs
Packaging Dimensions (WxDxH)	30.7" x 29.3" x 35.4"
Ice Cube Size half cube	.86"x.86".86"

Construction

Exterior Material	304 stainless steel
Interior Material	Polyethylene
Water Filter Capacity	2.2 GPM
UV Light Included For Sanitation	

Cooling

Refrigerant	R290
Temperature Display	Yes
Temperature Controller	Digital
Condenser Unit	Air
Compressor	Secop

Electrical

Voltage	115
Power	451W
Hz	60

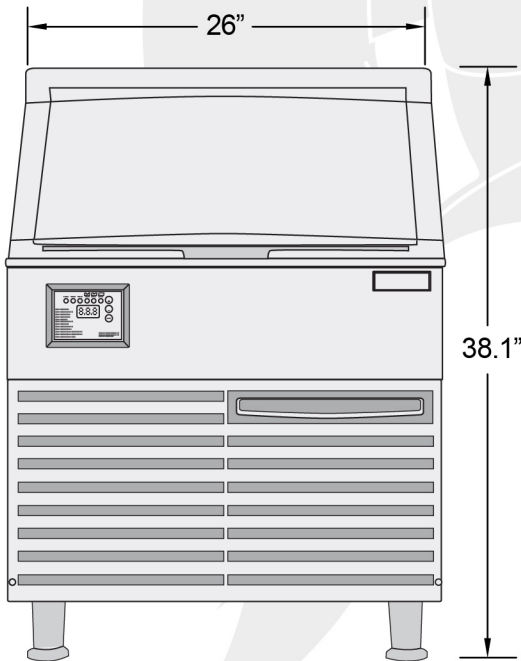

Front View

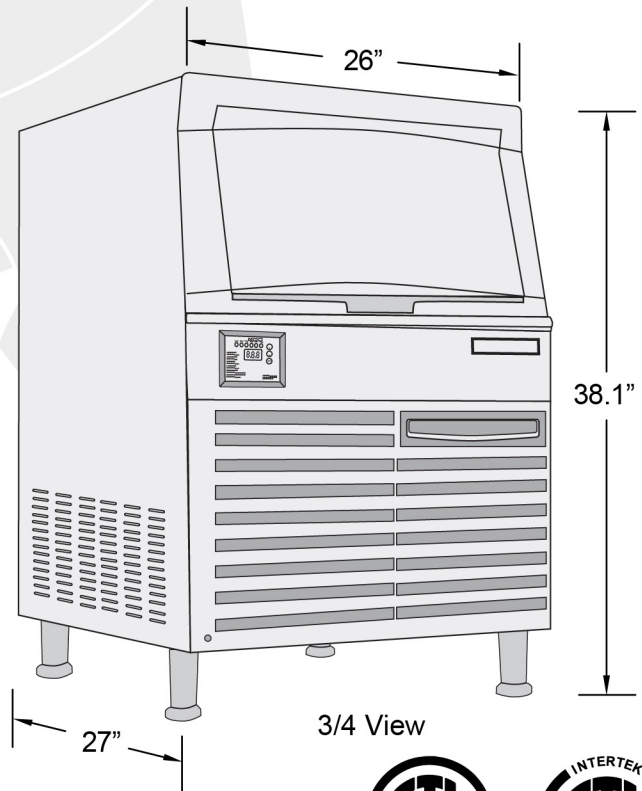

3/4 View



NEMA 5-15P



Intertek

COMPLIES WITH ANSI/NSF 7
FOR FOOD SERVICE