



Item # _____

Job _____



WIRE SHELVING ACCESSORIES

Decorator Shelf Inlays

Hardboard mats prevent small items from falling through wire shelves. Fit between posts and level with top of shelf edge. Single packed.

Material — 1/8" (3.2mm) thick cardboard with textured vinyl laminate on each side.

Cleaning instructions — May be wiped with damp cloth. Cannot be immersed in liquid.

Model No.	Width/Length		Description
	(in.)	(mm)	
1436BWI	14x36	355x914	Reversible, Black and White
1448BWI	14x48	355x1219	Reversible, Black and White
1824BWI	18x24	457x610	Reversible, Black and White
1836BWI	18x36	457x914	Reversible, Black and White
1848BWI	18x48	457x1219	Reversible, Black and White
2424BWI	24x24	610x610	Reversible, Black and White
2436BWI	24x36	610x914	Reversible, Black and White
2448BWI	24x48	610x1219	Reversible, Black and White

Note: Inlays interfere with the attachment of ledges and dividers. The user may modify the inlay to accommodate these accessories.

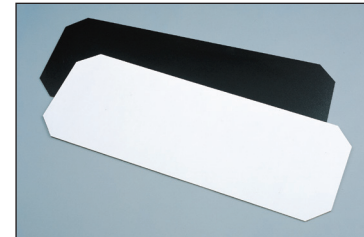

Decorator Shelf Inlays

Clear Shelf Inlays

Nearly invisible solid plastic mat retains the open-wire look of shelves and allows light penetration. Sold in packages of 4.

Material — 0.02" (0.5mm) thick PETG

Model No.	Width/Length	
	(in.)	(mm)
1436CI-4	14x36	355x914
1448CI-4	14x48	355x1219
1460CI-4	14x60	355x1524
1836CI-4	18x36	457x914
1848CI-4	18x48	457x1219
1860CI-4	18x60	457x1524
2136CI-4	21x36	530x914
2148CI-4	21x48	530x1219
2160CI-4	21x60	530x1524
2436CI-4	24x36	610x914
2448CI-4	24x48	610x1219
2460CI-4	24x60	610x1524



Clear Shelf Inlays

Triangle Shelves

Put unused corner space to work while keeping traffic aisles clear.

- Shelf sizes correspond to width (depth) of Super Erecta Shelving for add-on capability.
- Shelves attach to standard Super Erecta or quikSLOT posts.
- Weight capacity — 100 lb. (45.4kg)

Model No. Chrome	Model No. Black	Size Width		Approx. Pkd. Wt.	
		(in.)	(mm)	(lbs.)	(kg)
H18TRC	H18TRB	18	457	15 1/2	7
H24TRC	H24TRB	24	610	21 1/2	10

Not intended for mobile applications.
Maximum allowable usage height for free-standing unit is 54" (1370mm).



Triangle Shelf



InterMetro Industries Corporation
North Washington Street
Wilkes-Barre, PA 18705
www.metro.com





WIRE SHELVING ACCESSORIES

Aluminum Split Sleeves

Improved design is easier to install. For high temperature, over the road, or conductive applications. Zinc or stainless steel retainer rings available to secure shelf. One bag required per shelf; 4 pairs per bag.

Model No.	Description
9986Z	Aluminum Split Sleeves with Zinc Rings
9986S	Aluminum Split Sleeves with Stainless Rings

Note: Cannot be used with Super Adjustable shelves.



High Temperature Usage

Aluminum split sleeves — high temperature usage (Stationary Unit)

- A chrome plated Super Erecta wire shelving unit can be used to a maximum of 250°F (121°C).
- A stainless steel Super Erecta wire shelving unit can be used to 500°F (260°C).

For mobile units, please factor the usage requirements of the caster.

Replacement Plastic Split Sleeves for Super Erecta Shelves

One bag required per shelf; 4 pairs per bag.

Black. Model No. **9985**

White. Model No. **9985W**

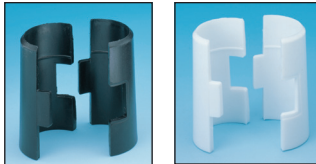

Note: White post caps and white split sleeves are standard with white designer shelving only.

Replacement Super Adjustable Super Erecta Corner Releases, Wedges, and Sleeves

Replacement parts for Super Adjustable and original Super Adjustable. One bag required per shelf. Each kit includes (4) corner releases, (4) wedges, and (4) sleeves.

Model No. **SAKITA2**



“S” Hooks

Use to eliminate two posts per adjacent unit. Sold individually. Two are required per shelf. Model No. **9995Z**

Notes:

- May only be used in stationary applications.
- Must use a minimum of (2) posts per adjacent add-on unit.
- Weight capacities of adjacent shelving units connected by “S” hooks – standard weight capacities of shelves and stationary units apply. For the most common configurations involving 54" (1370mm) or taller posts and 4-tiers of shelving, weight capacities are as follows: starter unit with (4) posts = 2,000 lbs. (907kg) evenly distributed; add-on unit with (2) posts and (2) “S” hooks per level = 2,000 lbs. (907kg) evenly distributed.
- The distance between two adjacent shelving units — collar to collar — connected by “S” hooks is 1/16" (1.6mm).



Security Shelf Connector Kit

Kit includes (2) “S” hooks, (2) screws, and (2) bolts. Used for added security to “add-on” shelving units. One connector kit required for each connection.

Chrome.

Model No. **H9995C**

Black.

Model No. **H9995B**

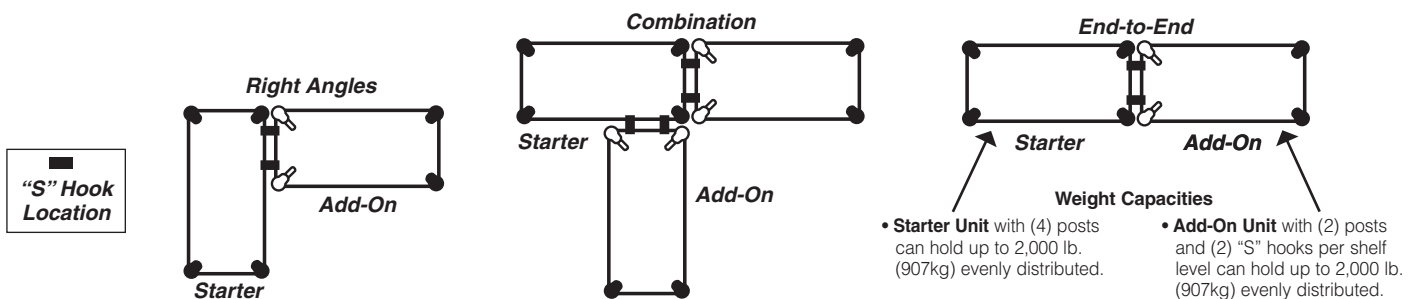

WIRE SHELVING ACCESSORIES

Post Clamps

Joins units together for maximum strength.
Zinc-plated. Model No. **9994Z**
Black. Model No. **9994BL**

Notes:

A post clamp adds 5/32" (4mm) between the base of the collars on adjacent units.
The distance between the snake frames on the adjacent units is 7/32" (6mm).
Enclosure panels CANNOT be attached on the ends where post clamps join adjacent units.



Hole Plugs (for Shelves)

This chrome-plated cover is used to fill shelf-corner openings.
Use whenever posts have been eliminated by "S" hooks.
Model No. **9997C**

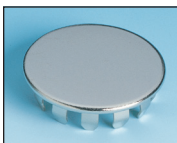

Foot Plates

Use to bolt units to the floor, or when a broader, more stable foot is desired. Replaces standard post leveling bolt.
Zinc. Model No. **9993Z**
Stainless Steel. Model No. **9993S**
Black. Model No. **9993BL**



Wall Clamps

Give single units greater stability.
Model No. **9984C**



Glides

Smooth polymer cover fits over leveling bolt to protect floors.
Material — HDPE
Model No. **9991P**

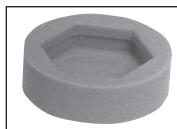

Decorative Leveling Foot

Decorative alternative for post. Compensates for uneven surfaces.
Chrome. Model No. **HDFC**
Black. Model No. **HDFB**



Decorative Casters

- Black nylon housing with non-marking polymer tread.
- 2 1/2" (63mm) models have threaded stem and attach to standard stationary shelving posts. Weight capacity of unit with (4) HDC3BB casters is 300 lb. (136kg).
- 4" (100mm) casters have a non-threaded stem and attach to standard mobile (-UP) posts. Weight capacity of a unit is 675 lb. (306kg)

Model No.	Type	Diameter	
		(in.)	(mm)
HDC3BB	Swivel/Brake	2 1/2	63
HDC5B	Swivel	4	100
HDC5BB	Swivel/Brake	4	100



HDC5B

HDC5BB



Keyboard Tray

Attaches to all Metro wire shelves, 36" (914mm) length or longer. Mouse Tray adapts to left or right of Keyboard Tray. Flip-top compartment provides convenient storage. Constructed of durable high-impact polystyrene. Assembles easily.

- Hardware included for attachment to Metro wire shelves; template provided for attachment to solid desk surfaces.
 - Keyboard Tray Dimensions: 22" L. (559mm) x 15 1/2" W. (394mm).
 - Dimension with Mouse Tray fully extended: 29 1/2" L. (749mm) x 15 1/2" W. (394mm).
- Model No. **CKS1522BL**



Keyboard Tray

Wire Management Device

Keeps wires and cables neatly organized both horizontally and vertically. Easily snaps over the edge of any Super Erecta wire or qwikSLOT shelf. Black epoxy finish.

Model No.	Width (in.) (mm)	Length (in.) (mm)	Approx. Pkd. Wt. (lbs.) (kg)
CWM	2 51	2 51	.5 .25



Wire Management Device

Power Strip

- Mounts quickly and easily to either a Super Erecta or qwikSLOT post.
- Includes a 15 foot (4572mm) long cord.
- Mounting brackets and hardware included.
- UL/CSA approved.
- 15 Amp Circuit Breaker.
- Illuminated Power Switch. 15A/125VAC.60Hz/1875 W.
- Gray/blue finish.
- 14/3 SJT Molded Power Supply Cord.

Model No.	Width (in.) (mm)	Length (in.) (mm)	Approx. Pkd. Wt. (lbs.) (kg)
CPS48	1 1/2 38	48 1219	6 2.72

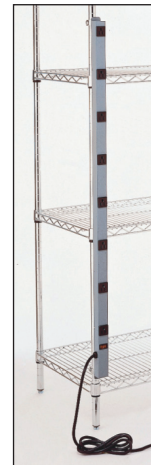

Power Strip

Surface Mount Swing Arm for Flat Monitor

Model No. **LTFMA**

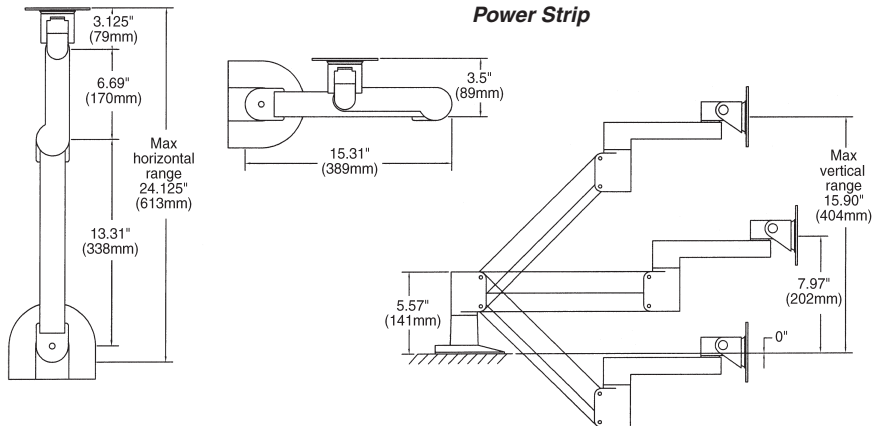

All Metro Catalog Sheets are available on our website: www.metro.com



InterMetro Industries Corporation
 North Washington Street, Wilkes-Barre, PA 18705
 Phone: 570-825-2741
 Product Information. U.S. and Canada: 1.800.992.1776
 Outside U.S. and Canada: www.metro.com/contactus

L02-009
 Printed in U.S.A. Rev. 03/14

Information and specifications are subject to change without notice. Please confirm at time of order

Copyright © 2014 InterMetro Industries Corp.

