



## Model: ARS-9

Belt Driven Forward Curved Centrifugal Blower Type

### Specification:

The supply fan unit shall be of the belt-driven, double inlet, forward curved centrifugal blower type. The blower assembly shall be mounted on vibration insulators. Drives shall be sized for a minimum of 150% of driven horsepower. Motor shall be continuous duty, double sealed bearings, thermally protected, and UL recognized. All exterior housing components of the supply unit shall be constructed of heavy gauge galvanized steel. No painting is required. The unit shall have a service access. The inlet of the unit shall contain a bank of washable, removable air filters. Filters shall be aluminum mesh type. The total fan package shall be furnished with a prewired disconnect for main power connection. All electrical components shall be UL listed, approved or classified where applicable and wired in compliance with the National Electrical Code. Wiring shall be complete, requiring only one-point field connection for power service. Supply fan unit shall be ETL-705 Listed. Supply fan unit shall be model ARS series as manufactured by Larkin Industries, Inc. 1-800-322-4036

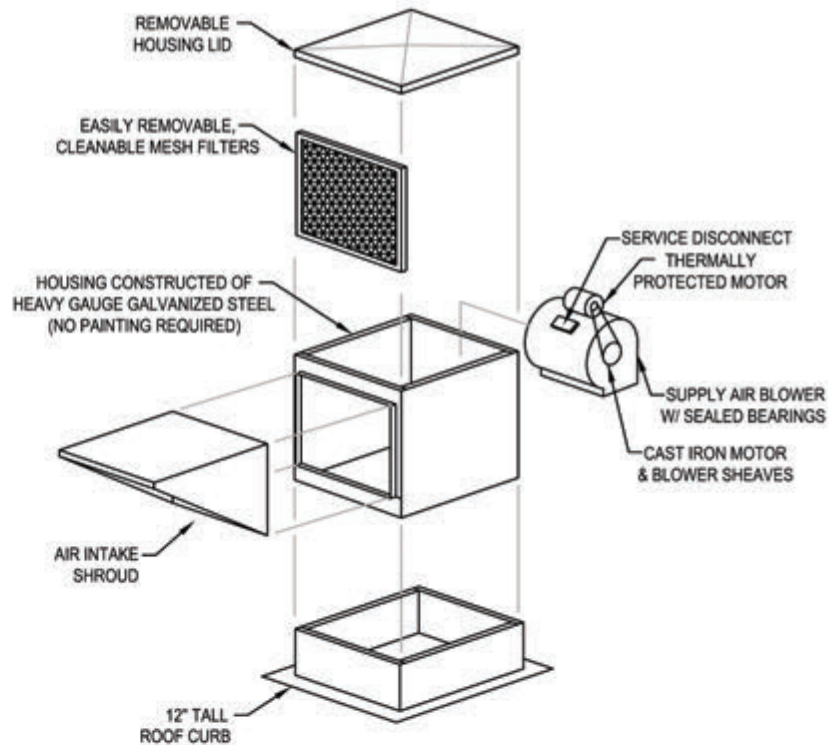
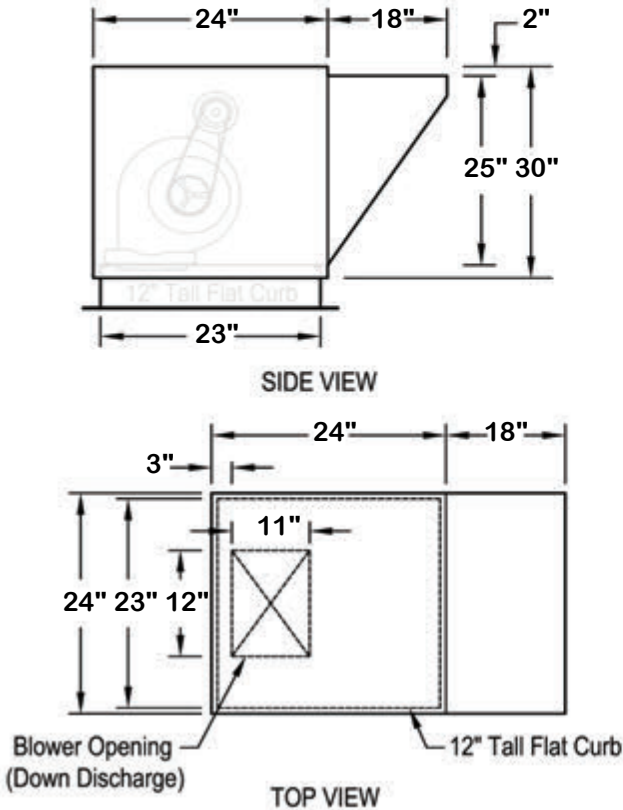

### Dimensional

Qty.	Weight (lbs)	Supply Fan Curb Size (in)	Roof Opening (in)	Filter Size (in)
1	195	23x23	21x21	(1)20x20x1

### Performance

Requested Volume (CFM)	Actual Volume (CFM)	Requested SP (in wg)	Actual SP (in wg)	Fan RPM
1442	1442	0.125	0.125	564

### Motor

Motor Mounted	Size (hp)	V/C/P	Encl.	Motor RPM	NEC FLA* (Amps)
Yes	1/4	115/60/1	ODP	1725	5.8

### Optional accessories:

- Auto back draft dampers
- Motorized back draft dampers
- Side discharge
- Wall mount platform
- Sloped roof curb
- Extended intake



### Features:

- Heavy gauge screwed together housing
- Easily removable cover
- Constructed of galvanized steel (painting not required)
- Double inlet supply blower, belt driven, mounted on vibration insulators
- Cast iron motor and fan drives
- Factory mounted disconnect switch
- Permanent lubricated bearings
- Cleanable aluminum mesh filters
- ETL listed
- Flat roof curb