

Safe-Serv™ Condiment Station

Hands-Free Foot Operated



Model 159870



Model 159867



Model 159868



Model 159869

Models

159867, 159868, 159869, 159870

Hands-Free Solution For Safe Volume Condiment Dispensing*

Benefits

- Cost-efficient, sanitary, and precise condiment serving for front-of-house or kitchen
- Converts hand operated pumps to foot operated
- Mechanical operation - **no power required**

Features

- Durable welded stainless steel construction is easy to clean and sanitize
- Field-adjustable pump shelf accommodates various hand operated dispensers
- Removable catch tray(s) for easy cleaning
- Single-, two-, three-, and four-pump stations available
- Single- and two-pump models move easily on 3" swivel wheels
- Floor space-saving compact 18" depth
- Convenient overhead storage shelf

Warranty

- Limited one-year on materials and workmanship

Condiment pumps shown are by Server Products, Inc.® and are not included.

Specifications:

Unit is of all-stainless steel construction, with cabinet of 16-gauge front and sides, and 20-gauge back. A 14-gauge flat stainless steel floor base extends on three sides of cabinet providing upright stability. Unit features foot pedal mechanism to convert hand operated bulk condiment pumps (not included) to hands-free foot operation. No power is required for dispensing operation. Dispenser shelf is height-adjustable in the field, with a 6¾" height range to accommodate various commercial hand pump dispensers. Cabinet back is easily removable for access to pump shelf adjustment. Catch tray(s) of 16-gauge stainless steel positioned under pump spout are removable for easy cleaning.

Models 159867 & 159868:

Includes two each 3" rear mounted wheels and a top handle for easy tilt-and-move mobile positioning.

* Patent Pending

Spec. #

AIA #

Lakeside Manufacturing, Inc.

4900 West Electric Avenue • West Milwaukee, WI 53219 U.S.A.

800-558-8565 • 414-902-6400 • Fax 414-902-6446 • info@eLakeside.com • www.eLakesideFoodservice.com

Safe-Serv™ Condiment Station

Hands-Free Foot Operated

Models

- 159867
- 159868
- 159869
- 159870

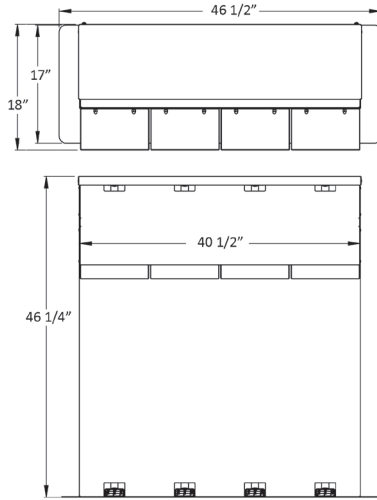

Model 159870

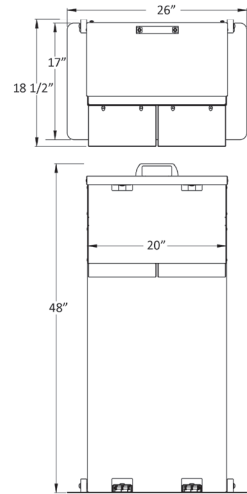

Model 159868

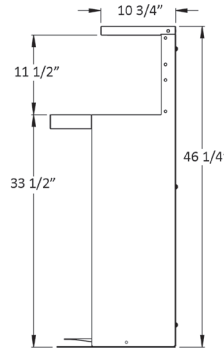

Side Elevation

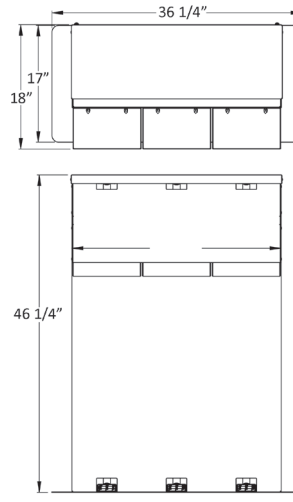

Model 159869

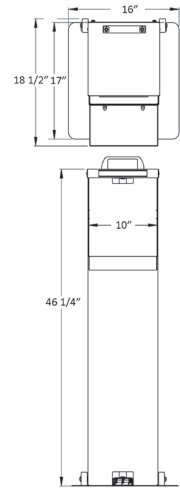

Model 159867

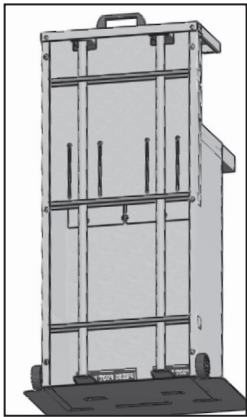

Opened Back Showing Mechanism And Access To Dispenser Shelf Adjustment

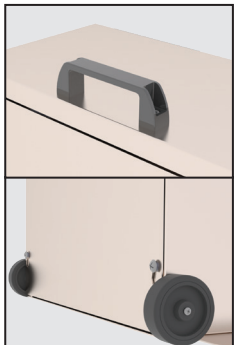

Top Handle & 3" Wheels on Models 159867 & 159868

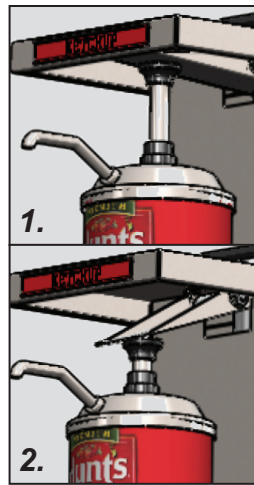

Pressing foot pedal activates overhead lever, pushing down on dispenser pump.

Model Information:

Model	Accommodates	Overall Dimensions*			3" Wheels	Ship Weight
		W	D	H		
□159867	1 Pump	16"	18½"	48"	Yes	72 lbs
□159868	2 Pumps	26"	18½"	48"	Yes	105 lbs
□159869	3 Pumps	36¼"	18"	46¼"	No	140 lbs
□159870	4 Pumps	46½"	18"	46¼"	No	170 lbs

* Includes floor base.



Condiment labels included, plus blank.



Lakeside Manufacturing, Inc.
 4900 West Electric Avenue • West Milwaukee, WI 53219 U.S.A.
 800-558-8565 • 414-902-6400 • Fax 414-902-6446
 info@eLakeside.com • www.eLakesideFooservice.com