

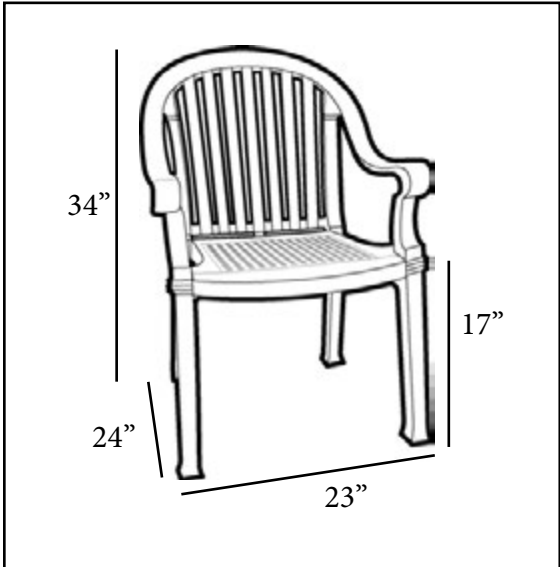

Colombo Classic Stacking Armchair



Passes ASTM F 1561-96 Class B performance standard for commercial outdoor seating

Features & Benefits **Warranty: 3 Yrs.**

- Comfortable highback armchair with firm back support and a true metal texture and finish.
- Made of Kevring® cast synthetic resin, a proprietary resin composite specifically developed to build durable replicas of metal furniture without the maintenance and at a fraction of the cost.
- Will stay cool in the hot sun.
- 2" x 2" legs with hard wearing footpads for structural rigidity.
- Rated to 300 pounds for safe use in commercial environments.
- Will retain its original color, texture, and finish without rusting, even when exposed to the rigors of the outdoor elements.
- Stacks for easy storage.

Product Specifications						
Product Description	Reference Number	Color	UPC Code 014306	Weight Each (lbs.)	Master Pack	Master Pack Volume (cu. ft.)
Colombo Classic Stacking Armchair	US650002	Charcoal	123479	11.50	12	40.25
	US496502	Charcoal	123479	11.50	4	20.76
	US650037	Bronze Mist	129761	11.50	12	40.25
	US496537	Bronze Mist	129761	11.50	4	20.76