



3.0 LITER | 1.0 GALLON AIRPOT COFFEE BREWING SYSTEM

CBS-2130 TOUCHSCREEN SERIES



CBS-2132XTS
Set up for 3.0L Brewing*

CBS-2131XTS
Set up for 3.0L Brewing*

The 3 Liter and 1 Gallon CBS-2131 / 2132 XTS Touchscreen Series Airpot Coffee Brewers are a perfect hot beverage solution for high volume self-service environments such as convenience stores, cafeterias, specialty coffee shops or office coffee service (OCS). Now experience total control of this fully featured Extractor® Brewing System via an inviting touchscreen interface display that is intuitive, easy to read and simple to navigate.



CBS-2132XTS
Set up for 1.0G Brewing*

CBS-2131XTS
Set up for 1.0G Brewing*

* Dispensers sold separately.

Perfect taste begins with a simple touch...

User Friendly Touchscreen

Access all controls via an inviting touchscreen interface display that blends intuitive icons with dynamic time and volume data to provide instant visual feedback at any point during programming, diagnostics or the brew cycle.



Streamlined Programming, Diagnostics and Metrics

The Extractor® Touchscreen Operating System (ETOS) was engineered for quick and efficient navigation through set-up, programming, diagnostics and daily operational brewing modes.



Customizable Screens

Customize the start screen to tie your equipment and product offerings into a consistent brand message. You can also create and display individual recipe names for quick and easy access to your most used coffee blends.



XTS™ Series

Driven by a user friendly touchscreen interface and intuitive software, the XTS series represents the next step in the evolution of FETCO's renown EXTRACTOR brewing technology.



Cascading Spray Dome™

Hot tank water flows over clog-free channels built into the dome and virtually eliminates spray head scale buildup – a leading reason for service calls.



Legendary Extractor® Control

Although designed specifically for smaller batch airport dispensing, these high quality brewers possess the legendary features and reliable performance you've come to expect from Extractor® branded products.

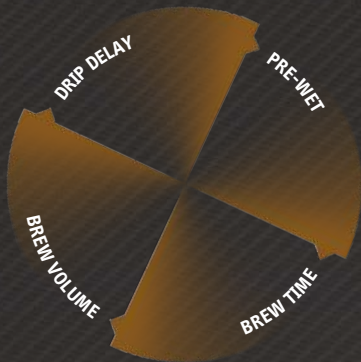

Efficient Design & Construction

FETCO equipment is designed and built to standards well above most others on the market today and can deliver significant energy savings when compared to similar competitor's products.



Modern Convenience

Duplicate profiles and parameters to and from any of the batch buttons on a single machine or copy the information to an unlimited number of brewers via a removable SD card (sold separately).



Contemporary Style

Sleek European cabinet design is attractive and fits well in any front-of-house decor found in cafes, lounges, OCS or corporate breakrooms.



Water Specification

Water Inlet 3/8" male flare fitting	Minimum Flow Rate 1 1/2 gpm [5.7 lpm]	Water Pressure 20-75 psig [138-517 kPa]
--	--	--

Electrical Configuration

Configuration Code	Heater Configuration	Voltage	Phase	Wires	KW	Electrical Connection	Max Amp Draw	Gallon [Liter] / Hour
E213153	1 x 1.5 kW	100-120	1	2+G	1.1-1.6	NEMA 5-15P ⁽³⁾	10.9-13.0	3.9 [14.8] ⁽¹⁾
E213151	1 x 2.3 kW	100-120	1	2+G	1.7-2.4	NEMA 5-20P ⁽³⁾	16.5-19.7	5.8 [22.0] ⁽¹⁾
E213157	1 x 3.0 kW	200-240	1	2+G	2.2-3.1	NEMA 6-15P ⁽³⁾	10.9-13.0	9.7 [36.7] ⁽¹⁾
UNIVERSAL VOLTAGE OPTIONS								
E213172	1 x 1.7 kW	120	1	2+G	1.8	NEMA 5-15P ⁽³⁾	14.7	4.4 [16.7] ⁽¹⁾
Optional ⁽²⁾	2 x 1.7 kW	120/208-240	1	3+G	3.5	L1 / L2 / N+G	14.7	8.7 [33.0] ⁽¹⁾
E213173	1 x 2.3 kW	120	1	2+G	2.4	NEMA 5-20P ⁽³⁾	19.7	5.8 [22.0] ⁽¹⁾
Optional ⁽²⁾	2 x 2.3 kW	120/208-240	1	3+G	4.7	L1 / L2 / N+G	19.7	11.0 [41.6] ⁽¹⁾

(1) Based on standard factory settings: 5.5 minute brew time; 0% prewet; 200°F water. 3 liters per batch.

(2) Sold with factory cord & plug for 120 Volt configuration. Optional user connection to a terminal block requiring L1, L2, N and ground to 120/208-240 VAC. No airpot locator for this group. User selectable for optional, dual in-series heater configuration.

(3) Sold with factory cord & plug.

Measurements

Height 26 1/4" [66.7 cm]	Width 11 3/4" [29.8 cm]	Depth 20 3/8" [51.8 cm]	Empty Weight 29 lbs [13.2 kg]	Filled Weight 55 lbs [25.0 kg]	Combined Filled Weight 66 lbs [30.0 kg] BREWER + 1 FILLED D041 DISPENSER	Hot Water Tank Cap. 3.3 gal [12.5 l]	Shipping Weight: 41 lbs [18.6 kg]	Shipping Dimensions: 30" x 17" x 22" [76.2 x 43.2 x 55.9 cm]
--------------------------------	-------------------------------	-------------------------------	-------------------------------------	--------------------------------------	--	--	---	--

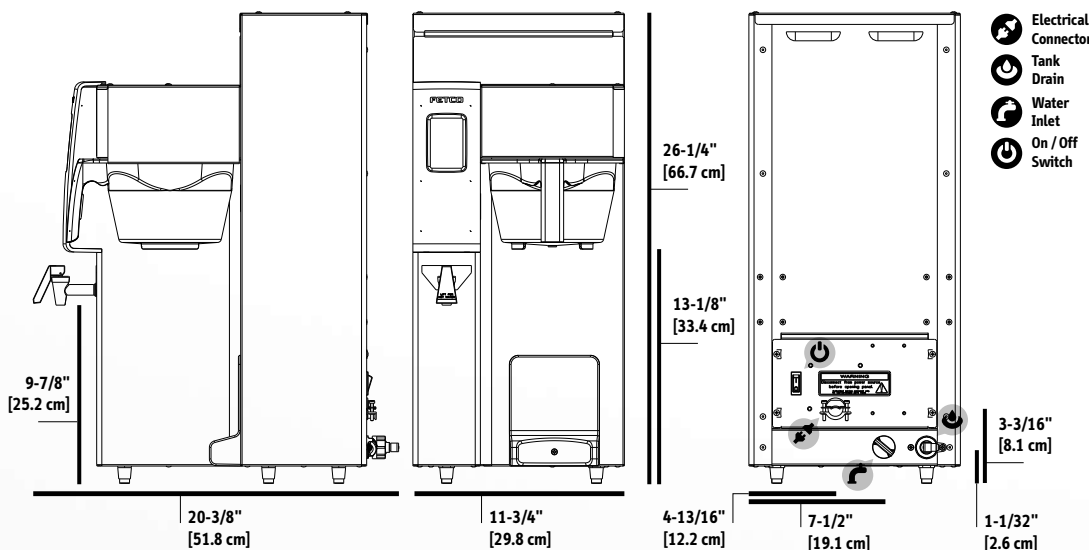

- Electrical Connector
- Tank Drain
- Water Inlet
- On / Off Switch

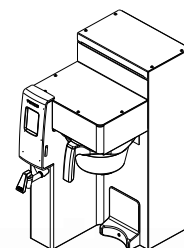
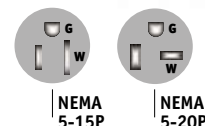

Compatible Dispensers

#D041
3.0L Thermal Pump
Lever Airpot
Product Dimensions
(HxWxD):
14 1/2" x 7" x 9"
[36.8 x 17.8 x 22.9 cm]
Weight (Empty / Filled)
4.6 lbs [2.1 kg] /
11.1 lbs [5.1 kg]



Paper Filter

#F002
13" x 5.5"
Standard Paper
Coffee Filter



Brew Basket

#B003218B1
13" x 5"
Stainless Steel
Brew Basket



#B014218BN2
13" x 5"
Plastic Brew Basket
w/ Brown Insert



Cups per Hour*

8oz.	123	16oz.	62
12oz.	82	20oz.	49

* Approximate based on maximum power setting.

Colored Brew Basket Handle Inserts



Blue:
1023.00180.00



Red:
1023.00190.00



Green:
1023.00191.00



Orange:
1023.00192.00

Water Specification

Water Inlet 3/8" male flare fitting	Minimum Flow Rate 1 1/2 gpm [5.7 lpm]	Water Pressure 20-75 psig [138-517 kPa]
---	---	---

Electrical Configuration

Configuration Code	Heater Configuration	Voltage	Phase	Wires	KW	Electrical Connection	Max Amp Draw	Gallon [Liter] / Hour
E213251	2 x 2.3 kW	200-240	1	2+G	3.3-4.7	Terminal Block	16.5-19.7	11.5 [43.5] ⁽¹⁾
E213252	2 x 3.0 kW	200-240	1	2+G	4.2-6.1	Terminal Block	21.3-25.5	14.0 [53.0] ⁽¹⁾

(1) Based on standard factory settings: 5.5 minute brew time; 0% prewet; 200°F water. 3 liters per batch.

Measurements

Height 26 1/4" [66.7 cm]	Width 19 3/8" [50.2 cm]	Depth 20 3/8" [51.8 cm]	Empty Weight 47 lbs [21.3 kg]	Filled Weight 92 lbs [41.7 kg]	Combined Filled Weight 114.4 lbs [51.9 kg] <small>BREWER + 2 FILLED D041 DISPENSERS</small>	Hot Water Tank Cap. 5.8 gal [22.0 l]	Shipping Weight: 55 lbs [25.0 kg]	Shipping Dimensions: 30" x 23" x 25" [76.2 x 58.4 x 63.5 cm]
---------------------------------------	--------------------------------------	--------------------------------------	--	---	--	---	--	---

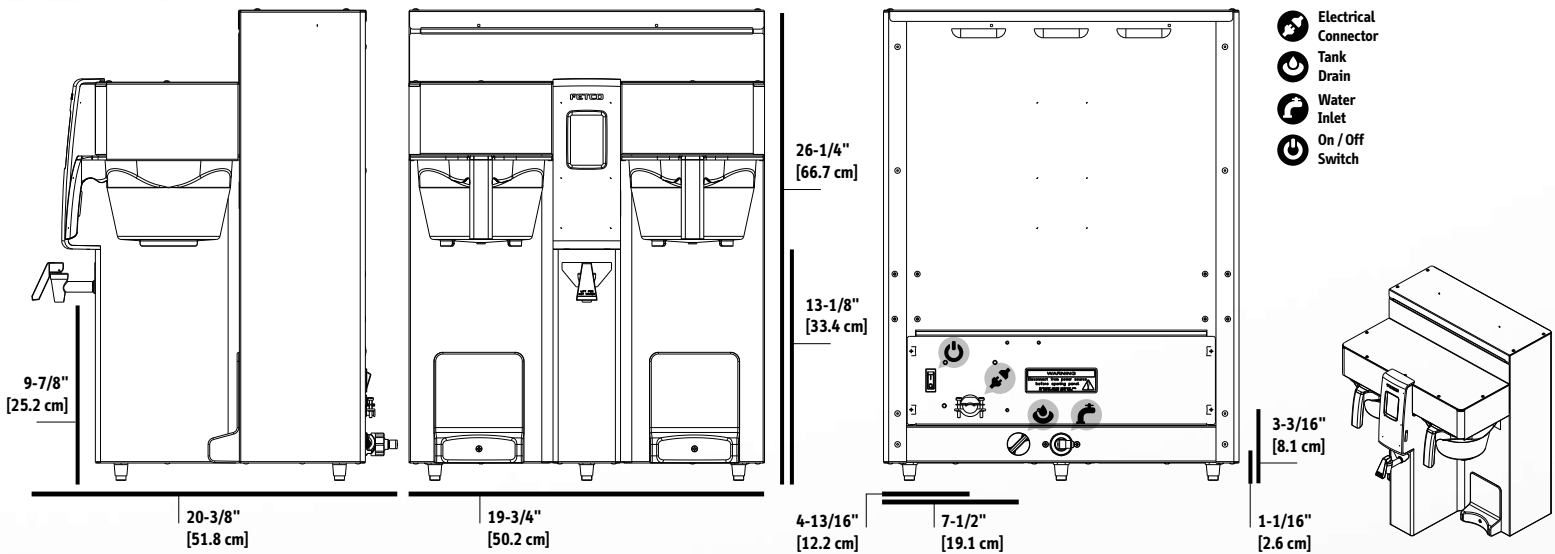

Compatible Dispensers

#D041
3.0L Thermal Pump
Lever Airpot
Product Dimensions
(HxWxD):
14 1/2" x 7" x 9"
[36.8 x 17.8 x 22.9 cm]
Weight (Empty / Filled)
4.6 lbs [2.1 kg] /
11.1 lbs [5.1 kg]



Paper Filter

#F002
13" x 5.5"
Standard Paper
Coffee Filter



Brew Basket

#B003218B1
13" x 5"
Stainless Steel
Brew Basket



#B014218BN2
13" x 5"
Plastic Brew Basket
w/ Brown Insert



Cups per Hour*

8oz. 224	16oz. 112
12oz. 149	20oz. 90

* Approximate based on maximum power setting.

Colored Brew Basket Handle Inserts



Blue:
1023.00180.00



Red:
1023.00190.00



Green:
1023.00191.00



Orange:
1023.00192.00

Water Specification

Water Connection Inlet 3/8" male flare fitting	Minimum Flow Rate 1 1/2 gpm [5.7 lpm]	Water Pressure 20-75 psig [138-517 kPa]	Default set for 3.0 Liter output. User must configure in field for 1.0 Gallon output.
---	--	--	--

Electrical Configuration

Configuration Code	Heater Configuration	Voltage	Phase	Wires	KW	Electrical Connection	Max Amp Draw	Gallon [Liter] / Hour
E213153	1 x 1.5 kW	100-120	1	2+G	1.1-1.6	NEMA 5-15P ⁽³⁾	10.9-13.0	3.9 [14.8] ⁽¹⁾
E213151	1 x 2.3 kW	100-120	1	2+G	1.7-2.4	NEMA 5-20P ⁽³⁾	16.5-19.7	5.8 [22.0] ⁽¹⁾
E213157	1 x 3.0 kW	200-240	1	2+G	2.2-3.1	NEMA 6-15P ⁽³⁾	10.9-13.0	9.7 [36.7] ⁽¹⁾
UNIVERSAL VOLTAGE OPTIONS								
E213172	1 x 1.7 kW	120	1	2+G	1.8	NEMA 5-15P ⁽³⁾	14.7	4.4 [16.7] ⁽¹⁾
Optional ⁽²⁾	2 x 1.7 kW	120/208-240	1	3+G	3.5	L1 / L2 / N+G	14.7	8.7 [33.0] ⁽¹⁾
E213173	1 x 2.3 kW	120	1	2+G	2.4	NEMA 5-20P ⁽³⁾	19.7	5.8 [22.0] ⁽¹⁾
Optional ⁽²⁾	2 x 2.3 kW	120/208-240	1	3+G	4.7	L1 / L2 / N+G	19.7	11.0 [41.6] ⁽¹⁾

(1) Based on standard factory settings: 5.5 minute brew time; 0% prewet; 200°F water. 3 liters per batch.
 (2) Sold with factory cord & plug for 120 Volt configuration. Optional user connection to a terminal block requiring L1, L2, N and ground to 120/208-240 VAC. No airpot locator for this group. User selectable for optional, dual in-series heater configuration.
 (3) Sold with factory cord & plug.

Measurements

Height 27 3/4" [70.5 cm]	Width 11 3/4" [29.8 cm]	Depth 20 3/8" [51.8 cm]	Empty Weight 29 lbs [13.2 kg]	Filled Weight 55 lbs [25.0 kg]	Combined Filled Weight 66 lbs [30.0 kg] <small>BREWER + 1 FILLED D063 DISPENSER</small>	Hot Water Tank Cap. 3.3 gal [12.5 l]	Shipping Weight: 41 lbs [18.6 kg]	Shipping Dimensions: 30" x 17" x 22" [76.2 x 43.2 x 55.9 cm]
--------------------------------	-------------------------------	-------------------------------	-------------------------------------	--------------------------------------	---	--	---	--

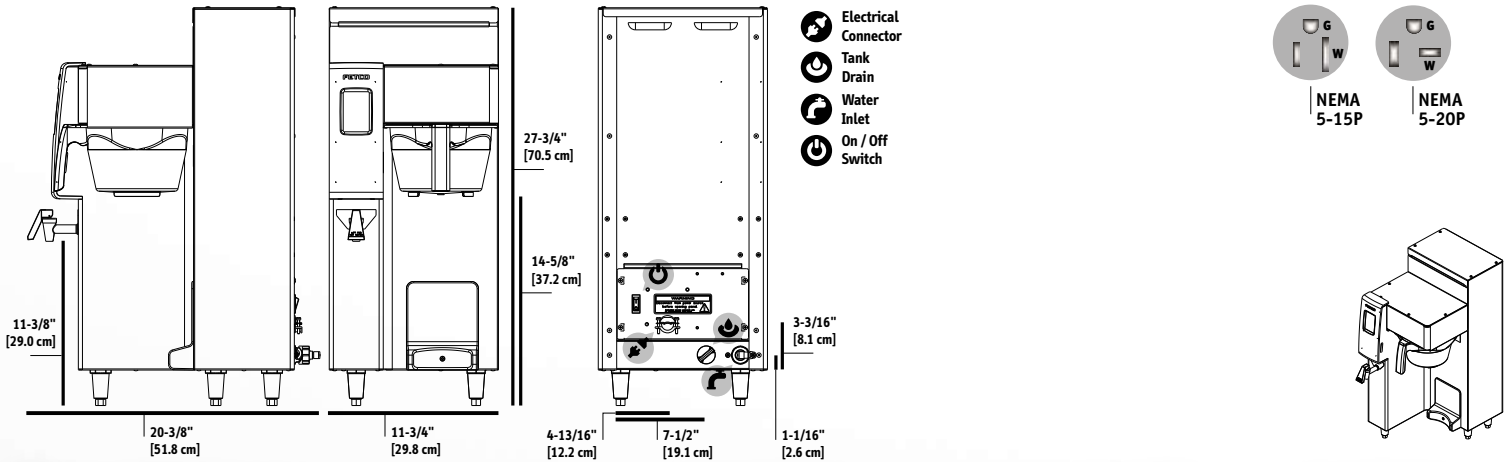

Compatible Dispensers

#D063
1.0 Gallon Thermal Pump Lever Airpot



Product Dimensions (HxWxD):
16 1/2" x 7" x 9"
[47.0 x 17.8 x 22.9 cm]
Weight (Empty / Filled)
9.0 lbs [4.1 kg] /
13.3 lbs [6.0 kg]

#D451
L4S-10
1.0 Gallon LUXUS® Thermal Dispenser



Product Dimensions (HxWxD):
13 1/2" x 8" x 11 1/2"
[34.2 x 20.3 x 29.2 cm]
Weight (Empty / Filled)
5.6 lbs [2.5 kg] /
12.4 lbs [5.6 kg]

* Must be used with S4S Serving Stations.

Serving Stations

#A147
S4S-10-1
Single Serving Station for L4S-10 Server



#A148
S4S-10-2
Twin Serving Station for L4S-10 Server



#A149
S4S-10-3
Triple Serving Station for L4S-10 Server



Paper Filter

#F002
13" x 5.5"
Standard Paper Coffee Filter



Brew Basket

#B003218B1
13" x 5"
Stainless Steel Brew Basket



#B014218BN2
13" x 5"
Plastic Brew Basket w/ Brown Insert



Cups per Hour*

8oz.	123	16oz.	62
12oz.	82	20oz.	49

* Approximate based on maximum power setting.

Colored Brew Basket Handle Inserts



Blue:
1023.00180.00



Red:
1023.00190.00



Green:
1023.00191.00



Orange:
1023.00192.00

Water Specification

Water Connection Inlet
3/8" male flare fitting

Minimum Flow Rate
1 1/2 gpm [5.7 lpm]

Water Pressure
20-75 psig [138-517 kPa]

Default set for 3.0 Liter output.
User must configure in field for 1.0 Gallon output.

Electrical Configuration

Configuration Code	Heater Configuration	Voltage	Phase	Wires	KW	Electrical Connection	Max Amp Draw	Gallon [Liter] / Hour
E213251	2 x 2.3 kW	200-240	1	2+G	3.3-4.7	Terminal Block	16.5-19.7	11.5 [43.5] ⁽¹⁾
E213252	2 x 3.0 kW	200-240	1	2+G	4.2-6.1	Terminal Block	21.3-25.5	14.0 [53.0] ⁽¹⁾

(1) Based on standard factory settings: 5.5 minute brew time; 0% prewet; 200°F water. 3 liters per batch.

Measurements

Height 27 3/4" [70.5 cm]	Width 19 3/4" [50.2 cm]	Depth 20 3/8" [51.8 cm]	Empty Weight 47 lbs [21.3 kg]	Filled Weight 92 lbs [41.7 kg]	Combined Filled Weight 115 lbs [51.9 kg] <small>BREWER + 2 FILLED D063 DISPENSERS</small>	Hot Water Tank Cap. 5.8 gal [22.0 l]	Shipping Weight: 55 lbs [25.0 kg]	Shipping Dimensions: 30" x 23" x 25" [76.2 x 58.4 x 63.5 cm]
--------------------------------	-------------------------------	-------------------------------	-------------------------------------	--------------------------------------	---	--	---	--

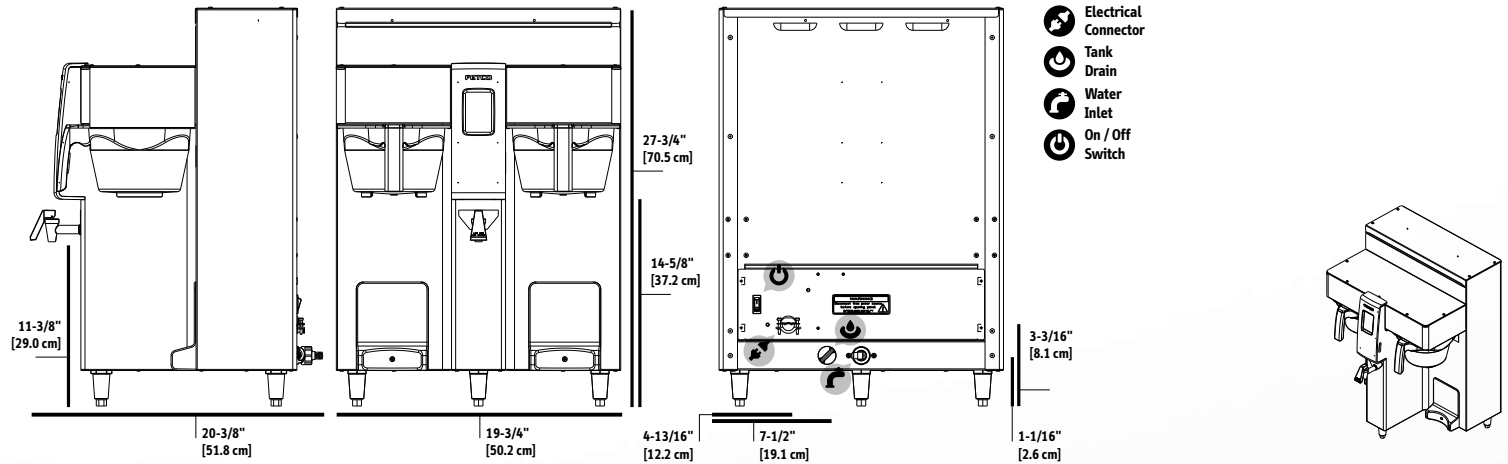

Compatible Dispensers

#D063
1.0 Gallon Thermal Pump Lever Airpot



Product Dimensions (HxWxD):
16 1/2" x 7" x 9"
[47.0 x 17.8 x 22.9 cm]
Weight (Empty / Filled)
9.0 lbs [4.1 kg] /
13.3 lbs [6.0 kg]

#D451
L4S-10
1.0 Gallon LUXUS® Thermal Dispenser



Product Dimensions (HxWxD):
13 1/2" x 8" x 11 1/2"
[34.2 x 20.3 x 29.2 cm]
Weight (Empty / Filled)
5.6 lbs [2.5 kg] /
12.4 lbs [5.6 kg]

* Must be used with S4S Serving Stations.

Serving Stations

#A147
S4S-10-1
Single Serving Station for L4S-10 Server



#A148
S4S-10-2
Twin Serving Station for L4S-10 Server



#A149
S4S-10-3
Triple Serving Station for L4S-10 Server



Paper Filter

#F002
13" x 5.5"
Standard Paper Coffee Filter



Brew Basket

#B003218B1
13" x 5"
Stainless Steel Brew Basket



#B014218BN2
13" x 5"
Plastic Brew Basket w/ Brown Insert



Cups per Hour*

8oz.	224	16oz.	112
12oz.	149	20oz.	90

* Approximate based on maximum power setting.

Colored Brew Basket Handle Inserts



Blue:
1023.00180.00



Red:
1023.00190.00

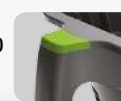

Green:
1023.00191.00



Orange:
1023.00192.00

Features & Benefits



	Feature	Benefit
1	Touchscreen Interface	Allows for quick and easy access to brew controls.
2	Brew Basket Sensors	Automatically discontinues operation of brew cycle if basket is removed.
3	Mixed Material Construction	Mixed material is attractive and comfortable in any front-of-house setting.
4	Manual Water Faucet	Safely dispenses hot water away from steam and brew basket.
5	Stainless Steel Finish	Withstands the harshest foodservice environments and is durable and easy to clean.
6	Fixed Dispenser Guide	Helps position airpot directly under brew basket drip hole for spill free brewing.

Dispensers sold separately.

FETCO[®]

© Copyright 2017 FETCO[®] is a mark of Food Equipment Technologies Company.

#SS14097

 fetco.com

 info@fetco.com

 847.719.3000
1.800.338.2699 USA
 847.719.3001

 Food Equipment Technologies Co.
600 Rose Road
Lake Zurich, IL 60047
USA