



IMPORTANT FOR FUTURE REFERENCE

Please complete this information and retain this manual for the life of the equipment:

Model #: _____

Serial #: _____

Date Purchased: _____

ENGLISH

Installation & Operation Manual
REDUCED OIL VOLUME
FRYING SYSTEM
Covering
Models
SSHLV14, SSHLV184 SERIES



TO THE PURCHASER, OWNER AND STORE MANAGER

Please review these warnings prior to posting them in a prominent location for reference.

TO THE PURCHASER

Post in a prominent location the instructions to be followed in the event that an operator smells gas. Obtain this information from your local gas supplier.

FOR YOUR PROTECTION

DO NOT store or use gasoline or other flammable vapors and liquids in the vicinity of this or any other appliance. Do not spray aerosols in the vicinity of this appliance when it is in operation.

WARNING

Improper installation, adjustment, operation, alteration, service or maintenance can cause property damage, injury or death. Read the installation, operating and maintenance instructions thoroughly before installing, operation, servicing this appliance.

WARNING

Installation, maintenance and repairs should be performed by a Pitco Authorized Service and Parts (ASAP) company technician or other qualified personnel. Installation, maintenance or repairs by an unauthorized and unqualified personnel will void the warranty.

WARNING

Installation and all connections must be made according to local codes in force. In the absence of local codes in North America, the installation must conform with the National Fuel Gas Code, ANSI Z223.1/NFPA 54 or the Natural Gas and Propane Installation Code CSA B149.1 as applicable. In Australia, the appliance must be installed in compliance with AS/NZS 5601.

WARNING

During the warranty period if a customer elects to use a non-original part or modifies an original part purchased from Pitco and/or its Authorized Service and Parts (ASAP) companies, this warranty will be void. In addition, Pitco and its affiliates will not be liable for any claims, damages or expenses incurred by the customer which arises directly or indirectly, in whole or in part, due to the installation of any modified part and/or received from an unauthorized service center.

WARNING

This appliance, when installed, must be electrically grounded in accordance with local codes, or in the absence of local codes, with the National Electrical Code, ANSI/NFPA 70, or the Canadian Electrical Code, CSA C22.2, as applicable and the hose must comply with AS/NZS 1869 and be class B or D.

WARNING

Adequate means must be provided to LIMIT the movement of this appliance without depending on the gas or electrical cord connection. Single appliances equipped with legs must be stabilized by installing anchor straps. All appliances equipped with casters must be stabilized by installing restraining chains.

WARNING

An appliance equipped with casters and a flexible gas line must be connected to the gas supply with a quick disconnect device. In North America this quick disconnect must comply with ANSI Z24.41. In Australia, the quick disconnect must comply with AS 4627.

WARNING

DO NOT alter or remove structural material on the appliance to accommodate placement under a ventilation hood.

WARNING

If the appliance is equipped with a power cord and it is damaged, it must be replaced by a Pitco Authorized Service and Parts (ASAP) company technician, or a similarly qualified person in order to avoid a hazard.

WARNING

The power supply must be disconnected before servicing, maintaining or cleaning this appliance.

WARNING

The appliance is NOT jet stream approved. DO NOT clean the appliance with a water jet.

WARNING

DO NOT attempt to move this appliance or transfer hot liquids from one container to another when the unit is at operating temperature or filled with hot liquids. Serious personal injury could result if skin comes in contact with the hot surfaces or liquids.

WARNING

DO NOT use an open flame to check for gas leaks!

WARNING

DO NOT sit or stand on this appliance. The appliance's front panel, tank, splash back, tank cover, workshelf, drain board is not a step. Serious injury could result from slipping, falling or contact with hot liquids.

WARNING

NEVER use the appliance as a step for cleaning or accessing the ventilation hood. Serious injury could result from slips, trips or from contacting hot liquids.

WARNING

The oil/shortening level should NOT fall below the minimum indicated level line at any time. The use of old shortening can be dangerous as it will have a reduced flash point and be more prone to surge boiling.

WARNING

The contents of the crumb catch and/or filter pan of any filter system must be emptied into a fireproof container at the end of the frying operation each day. Some food particles can spontaneously combust into flames if left soaking in certain oil/shortening materials.

WARNING

Completely shut the appliance down when shortening/oil is being drained from the appliance. This will prevent the appliance from heating up during the draining and filling process. Serious injury can occur.

WARNING

This appliance is intended for indoor use only.

WARNING

DO NOT operate appliance unless all panels and access covers are attached correctly.

WARNING

It is recommended that this appliance be inspected by a qualified service technician for proper performance and operation on a yearly basis.

WARNING

There is an open flame inside this appliance. The unit may get hot enough to set nearby materials on fire. Keep the area around the appliance free from combustibles.

WARNING

DO NOT supply the appliance with a gas that is not indicated on the data plate. If you need to convert the appliance to another type of fuel, contact your dealer.

WARNING

If gas flow to appliance is interrupted, or pilots extinguish, wait 5 minutes before attempting to relight the pilot to allow any residual gas in appliance to dissipate.

WARNING

Ensure that the appliance can get enough air to keep the flame burning correctly. If the flame is starved for air, it can give off a dangerous carbon monoxide gas. Carbon monoxide is a clear odorless gas that can cause suffocation.

WARNING

Never add oil to the appliance when it is at operating temperature. Splashing hot oil can cause severe injuries.

WARNING

Never add water to hot oil. Violent boiling can occur causing severe injury.

WARNING

This appliance is intended for professional use only and should be operated by fully trained and qualified personnel.

WARNING

To avoid splashing of hot liquid when installed, this fryer must be restrained either in the manner of installation, or with adequate ties to prevent tipping.

WARNING

In North America, gas appliances equipped with casters must be installed with connectors that comply with the Standard for Connectors for Movable Gas Appliances, ANSI Z21.69.CSA 6.16 Latest Edition. This connection should include a quick disconnect device that complies with the Standard for Quick Disconnect Devices for Use With Gas Fuel ANSI Z21.41.CSA 6.9 Latest Edition. In Australia, an appliance equipped with casters and a flexible gas line must be connected to the gas supply with a quick disconnect device that complies with AS 4627 and a restraining cable. The restraining cable must not exceed 80% of the length of the flexible gas line.

1. THEORY OF OPERATION	5
2. INSTALLATION.....	6
2.1. CHECKING AND UNPACKING YOUR NEW APPLIANCE	6
2.2. INSTALLATION CLEARANCES	6
2.3. LEVELING THE FRYER – LEGS/CASTERS	7
2.4. GAS CONNECTION.....	8
2.5. QUICK DISCONNECT CONNECTION	8
2.6. FUEL SUPPLY LINE LEAK AND PRESSURE TESTING	8
2.7. INSTALLATION SETUP	8
2.8. ELECTRICAL CONNECTIONS.....	9
2.9. VENTILATION AND FIRE SAFETY SYSTEMS.....	9
2.10. INSPECTION	10
2.11. INITIAL ADJUSTMENTS.....	11
2.11.1. FILLING THE APPLIANCE.....	11
2.11.2. LIGHTING INSTRUCTIONS.....	11
2.11.3. PILOT FLAME ADJUSTMENT.....	12
2.11.4. MAIN BURNER SYSTEM ADJUSTMENT.....	12
2.12. INITIAL CLEANING	13
3. OPERATION	14
3.1. OPERATIONAL FEATURES.....	14
3.2. BASIC OPERATIONAL FEATURES.....	15
3.3. FILLING THE FRY POT	16
3.4. FILLING THE TANK WITH LIQUID SHORTENING	16
4. APPLIANCE START UP	17
4.1. COOKING.....	18
4.2. COOKING TIPS	18
5. COMPUTER CONTROLLER OPERATION	19
5.1. TO TURN THE APPLIANCE ON:	19
5.2. TO TURN THE APPLIANCE OFF:.....	19
5.3. TO START A COOK:	19
5.4. TO CANCEL A COOK:	19
5.5. TO VIEW ACTUAL AND SET TEMPERATURES:	19
5.6. TO VIEW CURRENT SETTINGS FOR COOK, SHAKE, AND HOLD TIMES:	20
5.7. TO PERFORM A BOIL OUT OPERATION:.....	20
5.7.1. Automatic Boil Entry (Water Detection):.....	20
5.7.2. Manual Boil Entry:	20
5.8. TO ENTER PROGRAMMING LEVEL 1 (FOR THE STORE MANAGER):	21
5.9. TO SET COOK TEMPERATURE:	21
5.10. TO CHANGE A PRODUCT KEY–COOK, SHAKE, HOLD, AND HOLD PRE-ALARM TIMES:	21
5.10.1. Cook Time	21
5.10.2. Shake Time.....	21
5.10.3. Hold Time.....	21
5.10.4. Hold Pre-Alarm.....	22
5.11. TO EXIT LEVEL 1 PROGRAMMING:	22
5.12. TO ENTER PROGRAMMING LEVEL 2 (FOR THE STORE MANAGER)	22
5.13. FAHRENHEIT OR CELSIUS DISPLAY:	22
5.14. PASSWORD CHANGE OR REQUIRED?	22
5.15. BEEPER VOLUME AND TONE:	23
5.16. LANGUAGE SELECTION:.....	23
5.17. MELT CYCLE TYPE:.....	23
5.18. RECOVERY TEST VALUE:.....	23

INSTALLATION & OPERATIONAL SSHLV SERIES MANUAL

5.19.	CONTROL OR TIMER: (LEFT SIDE OF DUAL OR SINGLE VAT)	23
5.20.	CONTROL OR TIMER: (RIGHT SIDE OF DUAL VAT)	24
5.21.	OTHER DISPLAYS:	24
5.22.	COMPUTER SHUTDOWN	24
5.23.	FLUSH HOSE OPERATION (IF EQUIPPED)	24
6.	BASKET LIFT OPERATION	25
7.	PUSH BUTTON OIL TOP OFF SYSTEM	25
8.	AUTOMATIC OIL TOP SYSTEM (OPTION)	25
9.	QUICK STRAIN FILTERING “FILTER SOON” LIGHT FLASHING	26
10.	COOK COUNTER ADJUSTMENT	26
11.	APPLIANCE SHUTDOWN	27
11.1.	STANDBY MODE	27
11.2.	COMPLETE SHUTDOWN	27
12.	PREVENTATIVE MAINTENANCE	27
12.1.	DAILY PREVENTATIVE MAINTENANCE	27
12.1.1.	<i>FILTERING DAILY cleaning</i>	27
12.1.2.	<i>REPLACING THE FILTER MEDIA (if equipped)</i>	28
12.1.3.	<i>APPLIANCE INSPECTION</i>	29
12.1.4.	<i>CLEANING THE COOK TANK</i>	29
12.1.5.	<i>CLEANING THE CABINET</i>	29
12.1.6.	<i>FILTER CLEANING (If Equipped)</i>	29
12.2.	WEEKLY PREVENTATIVE MAINTENANCE	30
12.3.	MONTHLY PREVENTATIVE MAINTENANCE	30
12.3.1.	<i>BOIL OUT PROCEDURE</i>	30
12.3.2.	<i>TEMPERATURE CHECK</i>	31
12.4.	ANNUAL/PERIODIC PREVENTATIVE MAINTENANCE AND INSPECTION	32
12.4.1.	<i>Safety Evaluation</i>	32
12.4.2.	<i>Mechanical Inspection</i>	32
12.4.3.	<i>Temperature Control System</i>	32
12.4.4.	<i>Filter System (If Equipped)</i>	32
12.4.5.	<i>GAS COMBUSTION SYSTEM</i>	33
12.5.	VENTILATION HOOD	33
13.	TROUBLESHOOTING	34
13.1.	POWER FAILURE	34
13.2.	HIGH TEMPERATURE LIMIT SWITCH	34
13.3.	DRAIN VALVE INTERLOCK	34
13.4.	SELF CLEANING BURNER SYSTEM (NOT ON ALL MODELS)	35
13.5.	RESETTING THE SELF CLEANING BURNER SYSTEM TEMPERATURE LIMIT SWITCH	35
13.6.	TROUBLESHOOTING CHARTS	36
13.6.1.	<i>Fryer Troubleshooting Chart</i>	36
13.6.2.	<i>Filter troubleshooting chart (if equipped)</i>	36
13.6.3.	<i>COMPUTER & DIGITAL CONTROLLER DISPLAYS (IF EQUIPPED)</i>	37

1. THEORY OF OPERATION

The Pitco Low (or reduced) Oil Volume fryer works very similarly to the Pitco standard SG/SSH fryer.

The Low Oil Volume Fryer has a reduced cold zone to significantly reduce oil usage and extend oil life. This smaller zone may require more frequent filtering depending on the product being fried.

Upon turning the fryer on, the high limit closes the (side on) safety relay which stays closed until the fryer is turned off. If the oil temperature exceeds 450 deg F, the high limit opens and prevents further operation until the cooking oil has reached a safe cooking temperature. This places a minimum duty cycle on the safety (side on) relay to insure its proper operation when needed. The “heat demand” relay opens and closes on demand from the primary control to maintain the desired cooking temperature. When the “heat demand” relay closes, it energizes the main burners in the fry pot. Near the fryer pot heat tubes, the temperature probe and high limit can be found. The temperature probe provides a signal to the primary control, sensing the oil temperature in the fry pot.

The fryer is equipped with a manual “ADD OIL” button that can transfer fresh oil from a JIB (Jug in Box) located under the fryer or a bulk oil management system. The operator can use the manual “ADD OIL” button as needed to replenish any oil consumed in the cooking process. It is recommended that oil only be added when the fry pot is at the desired temperature, and that the “ADD OIL” button not be used to fill an empty fry pot from the JIB.

Optional Automatic Top Off: If equipped, the fryer (only when operating at desired temperature) senses the oil level and replenishes consumed oil only between cook cycles. There are no programming options for the operator or service technician, the control functions like any other Pitco electric fryer computer control. The “ADD OIL” switch (described above) is present with Auto Top Off.

2. INSTALLATION

2.1. CHECKING AND UNPACKING YOUR NEW APPLIANCE

Your new Pitco appliance has been carefully packed into one crate. Every effort has been made to ensure that it is delivered to you in perfect condition. Pitco does not assume responsibility for damage or loss incurred in transit.

1. Upon Delivery, inspect for visible shipping damage in the presence of the trucking operator. If something appears damaged, file a claim for damages regardless of extent.
2. Unpack and inspect unit for damage. Contact the shipper within 15 days and file a concealed damage claim; the shipper is only responsible for concealed damage for 15 days after delivery.
3. Remove the unit from the shipping pallet:
 - a: Remove the filter pan, and JIB pan from unit before attempting to dismount the unit from the shipping base.
4. Do not allow the full weight of the unit to rest on the legs or caster when removing the appliance from the shipping pallet. The casters can be bent or damaged if too much weight or force is applied to them from improper handling.
5. Check the packing list enclosed with your appliance to ensure that you have received all the parts to the appliance. If you are missing any parts, contact the dealer from whom the appliance was purchased.
6. Using the front cover of this manual, record the following for warranty service or future reference:
 1. Your Pitco model number.
 2. Fryer serial numbers (Found on the inner door of each fryer).
 3. The date purchased from your dealer invoice.

Once you have completed the above, the appliance is ready to be installed.

2.2. INSTALLATION CLEARANCES

The clearances shown below are for combustible and non-combustible installations and will allow for safe and proper operation of your appliance.

	Combustible Construction	Non Combustible Construction
	Inches (centimeters)	Inches (centimeters)
Back	6.0" (15.2cm)	0.0" (0.0cm)
Sides	6.0" (15.2cm)	0.0" (0.0cm)
Counter	6.0" (15.2cm)	6.0" (15.2cm)
Floor	9" (22.86 cm)	9" (22.86 cm)

In addition to the above clearances there must also be at least 30 inches (76.2cm) of aisle space in front of the unit.

WARNING
DO NOT obstruct the flow of ventilation air openings around the appliance. Adequate clearance around the appliance is necessary for servicing and proper component ventilation. Ensure that you meet the minimum clearance requirements specified in this manual.
WARNING
DO NOT install this appliance next to a water cooker, or use in any way in which water can come in contact with the hot oil. Splash over of water into hot oil may result in a steam eruption, potentially causing hot oil to be ejected from the fryer, and creating a burn hazard.

2.3. LEVELING THE FRYER – LEGS/CASTERS

CAUTION
To prevent equipment damage and/or personal injury, do not tilt the appliance onto any two of its casters or legs, or pull the appliance by the splash back.
WARNING
This appliance <u>must</u> be installed with the legs or casters provided by the manufacturer.
WARNING
DO NOT perform leveling procedure when appliance is in operation or full of hot liquids. Serious injury could result.

When you receive your appliance it is completely assembled with legs or optional casters. This appliance must be installed with legs or casters; it cannot be curb mounted, or sealed to a base. Curb mounting will seriously inhibit this appliance’s ability to effect proper component ventilation. The supplied legs or casters provide the necessary height to meet sanitation requirements and assure adequate air supply for electrical component ventilation. To level the fryer, use the following procedure.

Required tools: Large pair of water pump pliers, Medium flat blade screwdriver, level 12” long max.

- 1 Position appliance in final installed location.
- 2 Apply level across front, and then the left and right side of unit, determine lowest point, and distance to level.
- 3 Add the distance determined in step 2 to caster or leg on the lowest corner of appliance.
 - a. Swivel casters- loosen 2 set screws (A)
 - b. Legs and swivel casters-. Adjust the height of the leg / caster by turning adjustment collar/ foot (B) with water pump pliers until desired change in height is achieved.
 - c. Swivel casters only: Retighten set screws (A).
 - d. Fixed casters- Adjust height by moving wheel and axle to alternate holes in wheel bracket higher or lower as needed. Refer to Figure 3C “FIXED” type caster.
- 4 Adjust remaining casters or legs as needed to insure the appliance is supported evenly at each caster/leg contact point.

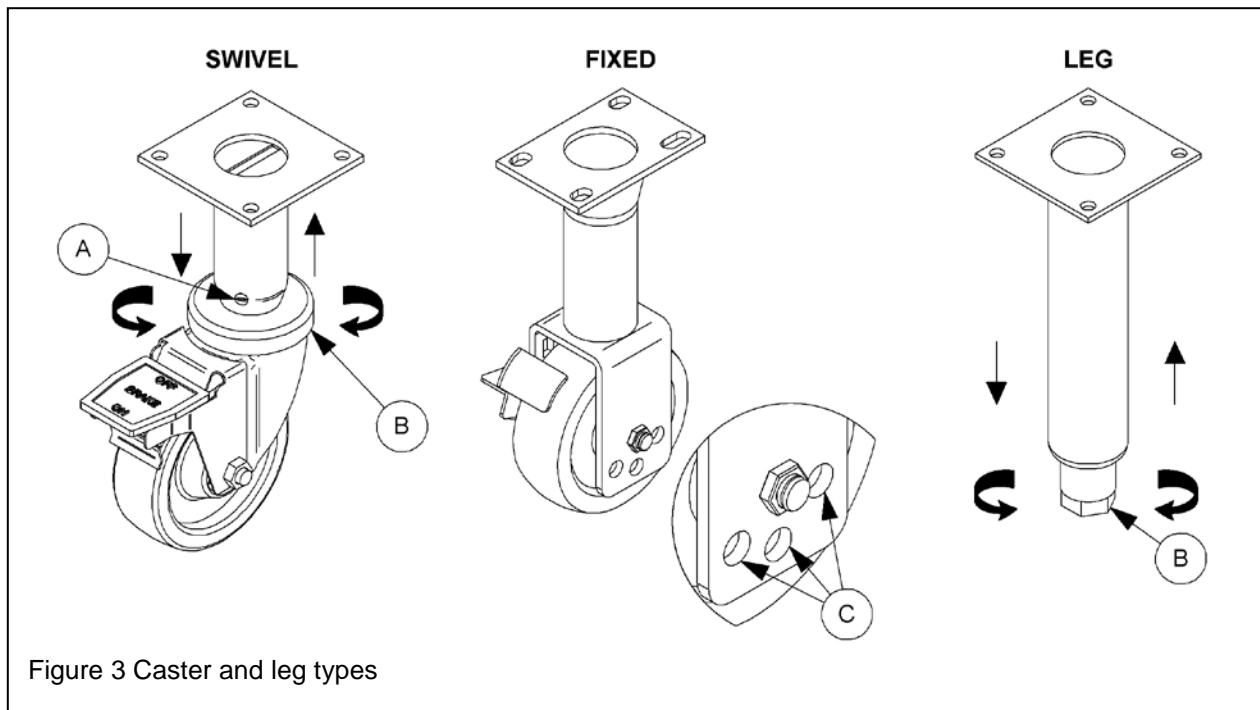

2.4. GAS CONNECTION

Your gas appliance will give you peak performance when the gas supply line is of sufficient size to provide the correct gas pressure. The gas line must be installed to meet the local building codes or National Fuel Gas Code ANSI Z223.1 Latest Edition. In Canada, install the appliance in accordance with CAN/CGA-B149.1 or .2 and local codes. In Australia, install the appliance in accordance with AS/NZS 5601. Gas line sizing requirements can be determined by your local gas company or, in North America, by referring to the National Fuel Gas Code, Appendix C, Table C-4 (for natural gas) and Table C-16 (for propane). The gas line needs to be large enough to supply the necessary amount of fuel to all appliances without losing pressure to any appliance. A properly sized and installed gas line will deliver a supply pressure between 7.0" W.C. (17.4mbars, 1.74kPa) and 10.0"W.C. (24.9mbars, 2.49kPa) natural gas or between 11.0"W.C. (27.4mbars, 2.74kPa) and 13.0" W.C. (32.4mbars, 3.25kPa) for propane to all appliances connected to the supply line, operating simultaneously at full demand. The pressure at the gas valve shall not exceed ½ PSI.

The gas supply connection to this appliance is located in the rear of the appliance approximately 10-1/2" (26.7 cm) from the floor of the appliance when legs are used.

Each appliance is equipped to operate on one certain fuel type. The type of fuel with which the appliance is intended to operate is stamped on the data plate, which is attached to the inside of the door.

WARNING

NEVER supply the appliance with a gas other than the one that is indicated on the data plate. Using the incorrect gas type will cause improper operation and could result in serious injury or death. If you need to convert the appliance to another type of fuel, contact the dealer you purchased it from.

NOTICE

NEVER use an adapter to make a smaller gas supply line fit the appliance connection. This may not allow proper gas flow for optimum burner operation, resulting in poor performance and improper operation.

2.5. QUICK DISCONNECT CONNECTION

In North America, gas appliances equipped with casters must be installed with connectors that comply with the Standard for Connectors for Movable Gas Appliances, ANSI Z21.69.CSA 6.16 Latest Edition. This connection should include a quick disconnect device that complies with the Standard for Quick Disconnect Devices for Use With Gas Fuel Appliances ANSI Z21.41.CSA 6.9 Latest Edition. In Australia, an appliance equipped with casters and a flexible gas line must be connected to the gas supply with a quick disconnect device that complies with AS 4627 and a restraining cable. The restraining cable must not exceed 80% of the length of the flexible gas line. The restraining device should be attached to the appliance at the back panel.

2.6. FUEL SUPPLY LINE LEAK AND PRESSURE TESTING

The fuel supply system must be tested before the appliance is used. If the fuel line is going to be tested at a pressure greater than ½ PSIG (3.45 kPa, 34.5 mbar), insure that that appliance is disconnected from the fuel line. If the fuel line is to be tested at a pressure equal to or less than ½ PSIG (3.45 kPa, 34.5 mbar), the appliance can be connected during the test, but the unit's gas valve must be shut. Test all gas line connections for leaks with a solution of soap and water when pressure applied.

2.7. INSTALLATION SETUP

The installation of this appliance *MUST* conform to local codes. In the absence of local codes in North America, the installation must conform with the National Fuel Gas Code, ANSI Z223.1/NFPA 54 or the Natural Gas and Propane Installation Code CSA B149.1 as applicable. In Australia, the appliance must installed in compliance with AS/NZS 5601 (current revision)

2.8. ELECTRICAL CONNECTIONS

It is advised that this power supply be plugged into a wall receptacle that is controlled by the ventilation control. This will prevent the appliance from being operated without the ventilator on. If your appliance requires an electrical connection, the power requirements are listed below.

A full version of the wiring diagram can be found adhered to the inner door(s) of the appliance.

	North America	International
Input Voltage	120 VAC, 50/60 Hz	220, 230 or 240 VAC 50/60 Hz
Current per unit	1.0 Amp	0.5 Amps
Filter Current	7.5 Amp	4.2 Amps
Heat Tape	0.4 Amp	0.2 Amps

CAUTION
Connecting the appliance to the wrong power supply may damage the appliance and void the warranty.
WARNING
This appliance must be connected to a power supply having the same voltage and phase as specified on the data plate located on the inside of the appliance door.
WARNING
DO NOT attempt to connect the appliance to an electrical supply other than that indicated on the data plate. Electrical connection should be performed by qualified personnel.
WARNING
The electrical connection used by this appliance must comply with local codes. In the United States if there are no local codes that apply, refer to the National Electrical Code (NEC), ANSI/NFPA 70 for installation in the US. In Canada, refer to CSA Standard C22.2 and local codes. In all other cases, refer to local and national codes and regulations.
WARNING
If your appliance is equipped with an oil proof, electrical supply cord with a three-prong safety plug. This is to protect operators from electrical shock hazard in the event of an equipment malfunction. DO NOT cut or remove the grounding (third) prong from this plug; it should be plugged into a properly grounded three-prong receptacle.

2.9. VENTILATION AND FIRE SAFETY SYSTEMS

Your new appliance must have proper ventilation to function safely and properly. Exhaust gas temperatures can reach as high as 1100 °F (593 °C). Therefore, it is very important to install a fire safety system. Your ventilation system should be designed to allow for easy cleaning. Frequent cleaning and proper maintenance of the ventilation system and the appliance will reduce the chances of fire. Ventilation and fire safety systems must comply to local and national codes for US and Canada. Refer to ANSI 83.11 for a list of reference documents that will provide guidance on ventilation and fire safety systems. For installations in U.S. and Canada, additional information can be obtained from CSA International, 8501 East Pleasant Valley Road, Cleveland, OH, 44131 or visit their website at www.csa-international.org. In Australia the ventilation system must comply with AS/NZS 5601.0.

It is essential that the appliance be operated only when adequate ventilation is provided. Your ventilation hood should be properly maintained. A qualified installation professional should ensure that the hood is operating properly in conjunction with the appliance. Inadequate ventilation may not properly evacuate appliance all emissions. Excessive or unbalanced ventilation may cause drafts, which could interfere with proper operation of the pilot and burners. Leave at least 18 inches (47cm) of open space between the flue of the appliance and the intake of the exhaust hood.

WARNING

Ensure that your ventilation system does not cause a down draft at the appliance's flue opening. A down draft will not allow the appliance to exhaust properly and will cause overheating, which may cause permanent damage. Damage caused by down drafts will not be covered by the warranty. NEVER allow anything to obstruct the flow of combustibles or ventilation exiting the appliance. NEVER place anything on top of the flue area, or block the flue in any way. Never place a grease condensing drip pan over the flue opening.

WARNING

NEVER connect the ventilation blower or hood directly to the flue of this appliance. The resulting increased flow of air through the combustion system will cause improper operation, poor temperature recovery, poor ignition and could extinguish the pilot.

WARNING

Replacing or adding appliances under a pre-existing fire safety system may require modifications to the system. ALWAYS contact a professional who is qualified in installing, designing and maintaining your fire safety system to assure that any appliances located under the fire safety system are adequately protected.

For Australia, the fryer must be installed in accordance with AS/NZS 5601, local authority and any other relevant statutory regulations. Flexible hose (if used) must comply with AS/NZS 1869 Class B or D, be of appropriate internal diameter, be kept as short as possible (not exceed 1.2 meters), must not be kinked and not be in contact with a hot surface. A chain must be fitted to restrict the fryer movement to no more than 80% of the hose length.

2.10. INSPECTION

Before you begin filling and adjusting the appliance, perform the following visual checks:

- ✓ After the appliance is in its permanent location, check the levelness. Any additional leveling that is necessary can be performed as previously described.
- ✓ Ensure that the sensing probe and high temperature limit bulb are in place and secure. Check the high limit bulb mounting screws to ensure that they are tight.
- ✓ Review the installation portion of this manual and ensure that all steps have been followed and executed properly.

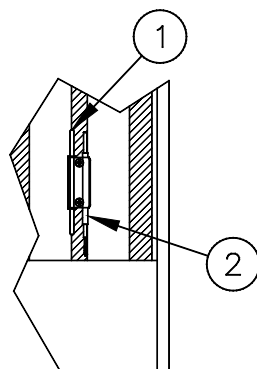

- 1) Probe
- 2) High Temperature Limit

2.11. INITIAL ADJUSTMENTS

After your appliance has been properly installed as described in the installation section of this manual, it will need to be adjusted to ensure that it will perform as designed. A qualified person must perform these adjustments.

To perform these adjustments the following tools will be needed:

- Manometer
- Digital Thermometer (Temperature Probe)
- DC Microammeter
- DC Voltmeter

2.11.1. FILLING THE APPLIANCE

Refer to the following procedure to fill the cook tank prior to operation.

1. Ensure that the drain valve is closed.
2. Fill the tank with oil/shortening until the oil/shortening reaches the level line(s). Never let the oil/shortening level go below the MIN LEVEL mark stamped on the tank.



PUSH BLUE HANDLE IN

WARNING
Oil/shortening must completely cover the heat tubes at all times while appliance is on.

CAUTION
This appliance is not designed for cooking with water. Fill with oil/shortening only.

WARNING
During operation there is an open flame inside this appliance. The unit may get hot enough to set near by materials on fire. Keep the area around the appliance free from combustibles.

2.11.2. LIGHTING INSTRUCTIONS

There is nothing to manually light on the SSHLV system. Pilot ignition is performed and controlled by the electronic ignition system. Refer to the following instructions to light the appliance.

1. Open the gas supply valves to the appliance.
2. Turn the gas valve knob to the ON position.
3. Turn the controller on.

Press the * button to turn the COMPUTER on.

*

4. The main burners will light and be controlled by the computer.

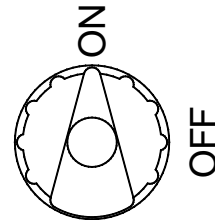

Note: If your appliance has a self cleaning burner system, the burners may make a popping sound immediately after the main burners light during startup. This noise during startup is part of the normal operation of the self cleaning burner system and should NOT continue during normal cooking & idle periods. (SCB Only)

WARNING

Do not store flammable materials in or near this appliance. Do not spray aerosols in the vicinity of this appliance while it is in operation. Contact a qualified service person or the factory, using the information on the back of this manual, if the appliance produces unusual odor, yellow tipping flames or is not performing as per the original installation.

2.11.3. PILOT FLAME ADJUSTMENT

Perform this procedure with the pilot lit.

Note: This procedure requires the use of a DC microammeter.

1. Connect the DC microammeter between the flame sensor terminal and the flame sensor lead. Observe proper polarity: if the meter needle goes below 0, reverse the leads. The current reading must be 1.0 μ A or greater, (0.15 μ A or greater for CE units).
2. Adjust the current reading to the required level by adjusting the pilot flame. Remove the pilot adjustment screw cap to expose the pilot adjustment screw. Turning the pilot adjustment screw clockwise will decrease the size of the pilot flame and flame sense current. Turning the pilot adjustment screw counterclockwise will increase the pilot flame size and the flame sense current.
3. Rotate the screw in the direction needed to achieve a reading of 1.0 μ A or greater, (0.15 μ A or greater for CE units).

Note: Allow 3 to 5 minutes between flame adjustments to allow the reading to stabilize.

4. Once the pilot flame has been adjusted properly, replace the pilot adjustment screw cap screw and remove the microammeter.

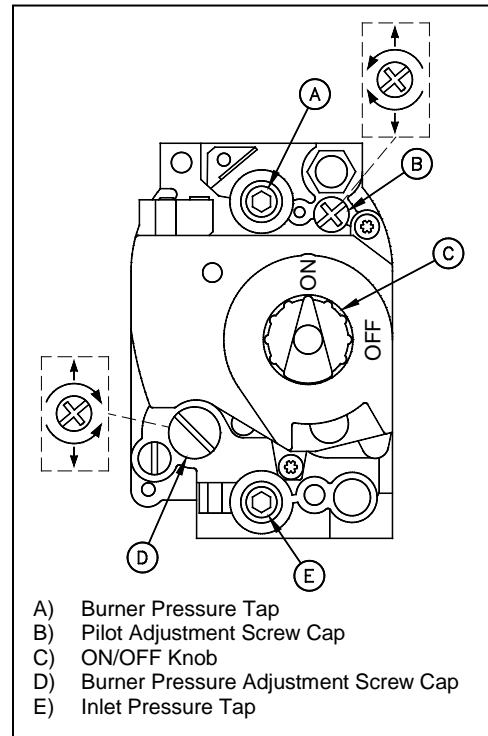

2.11.4. MAIN BURNER SYSTEM ADJUSTMENT

For the main burners to operate the gas supply valve must be open and the main power button on the computer must be pressed. The main burners receive gas from the main gas supply through the thermostatically controlled valve. When the oil temperature drops below the preset temperature the gas control valve opens.

The main burners must be adjusted to deliver optimum flame. Refer to the following procedure to adjust the main burners.

1. Ensure that the main gas valve is shut off, remove the manifold pressure tap plug and connect an accurate pressure gauge (range of 0-16 "W.C. (39.85mbar, 3.98kPa) in 0.1" (.25mbar, .02kPa) increments) or manometer.
2. Turn on this and all appliances connected to the gas supply line and light their main burners. The pressure reading of the installed pressure gauge should not drop from the required installation pressure. Any loss of pressure indicates inadequate supply line installation, which will cause poor performance of all appliances during peak usage.
3. The installed pressure gauge should be the same, ± 0.1 " W.C. (.25mbar, .02kPa), as that marked on the data plate on the inside door of the appliance. If the pressure is correct, go to step 6, if it is not, adjust the pressure as outlined in step 4.

To adjust the pressure, remove the regulator adjustment screw cap and, with a flat head screwdriver, adjust the regulator screw until the proper burner pressure is reached. Turning the screw clockwise will increase the burner pressure. Turning the screw counterclockwise will decrease the burner pressure.

4. When the pressure is correct, replace the regulator adjustment screw cover.
5. Turn off the ALL appliances, shut the main gas valve to your Pitco appliance and remove the pressure gauge. Apply pipe joint compound to the manifold pressure tap plug and reinstall it.

CAUTION
Be careful not to disturb the probe and high temperature limit during operation and cleaning of this appliance.

2.12. INITIAL CLEANING

When your appliance is shipped, many of its parts are covered with a thin coat of oil for protection. Before the appliance is ready for cooking all transit material must be removed and the appliance must be cleaned. This will remove the oil coating and any foreign matter that may have accumulated during storage and shipment. Refer to the following procedure to clean the appliance.

WARNING
Wear protective gloves and clothing when cleaning and draining the appliance and when disposing of water. The water is extremely hot and can cause severe injuries.

CAUTION
DO NOT leave the appliance unattended during cleaning. Never let the liquid level go below the heat tubes.

1. Read the “operation” section of this manual prior to filling or operating the appliance.
2. The following steps should be followed using a grease dissolving commercial cleaner.

WARNING
Use a commercial grade cleaner formulated to effectively clean and sanitize food contact surfaces. Read the directions and precautionary statements before use. Particular attention must be paid to the concentration of cleaner and the length of time the cleaner remains on the food contact surfaces.

3. Following the manufacturer’s directions, clean the tank interior and all other food contact surfaces.
4. When cleaning is complete, rinse the inside of the tank thoroughly with cool water. Continue to rinse the tank until the cleaner has been completely and thoroughly rinsed from the tank.
5. Using a clean dry cloth, wipe out all of the water.
6. Repeat the previous steps to clean the bread and batter station or filter pan if equipped.

If the appliance can’t be adjusted to operate properly contact a qualified service person or contact the factory using the contact information on the back of this manual.

3. OPERATION

An operator's manual for your appliance's specific control type should be included with this manual. Refer to that manual prior to operating this appliance.

WARNING
Before operating the fryer, check that tipping restraints or other features to prevent tipping are installed and mechanically sound. Splashing of hot liquid may occur if adequate means of securing the fryer in place are not used.

3.1. OPERATIONAL FEATURES

The diagram below outlines some of the key operational components of your appliance. Refer to the following sections of this manual to learn more about these features.

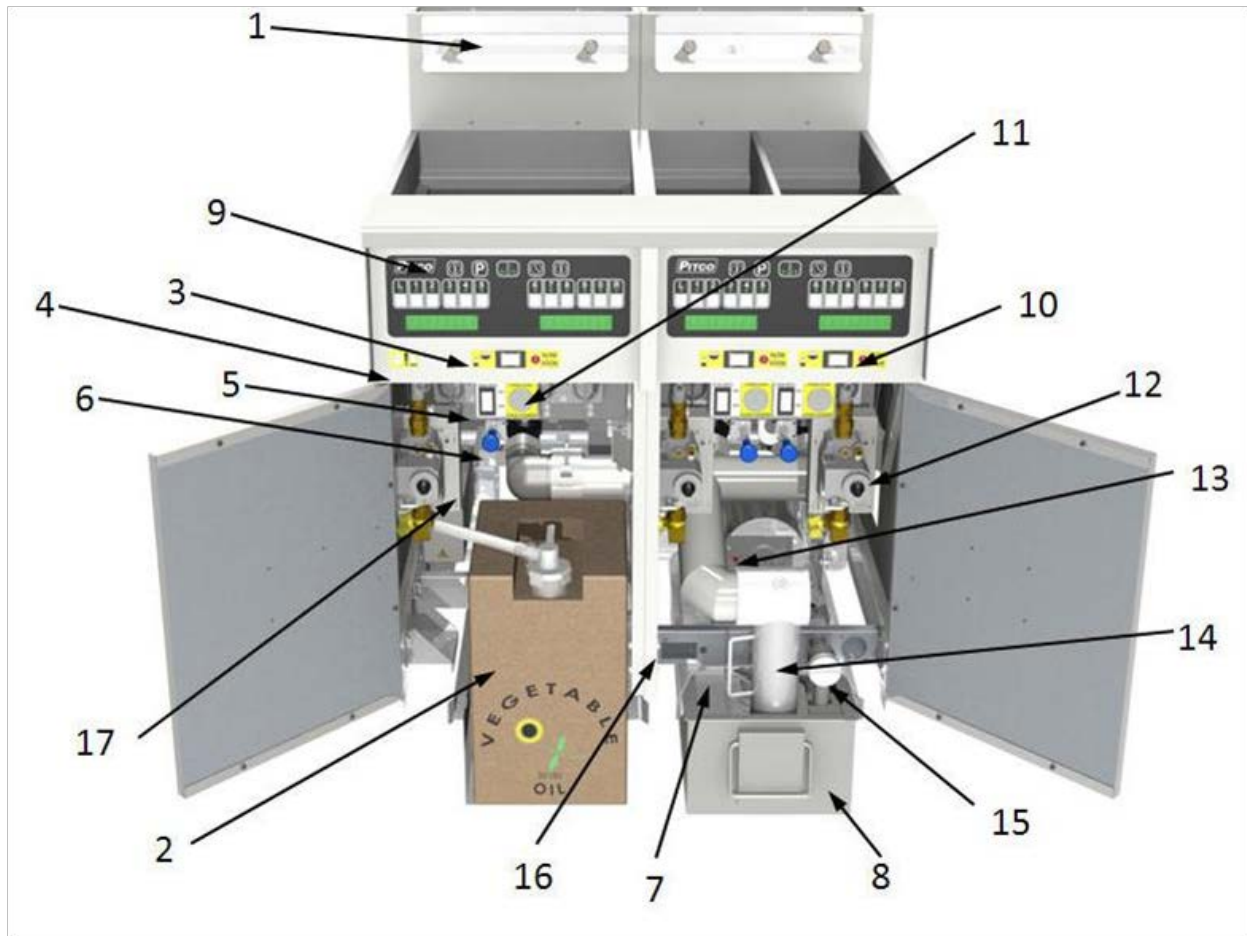

3.2. BASIC OPERATIONAL FEATURES

1. **Basket Hanger** - Holds fry baskets while draining or between loads. Lifts off for easy cleaning.
2. **Fry pot oil top off supply jug**- Supplied by others, provides on board storage for fresh cooking oil.
3. **Oil Top Off Switch (OPTIONAL)** - Replenishes oil in frypot.
4. **JIB (Jug in Box) Status Light (YELLOW)**- Indicates oil jug is nearing empty.
5. **Filter Return Switch** - controls the frypot return valve, and starts filter pump to filter or refill frypots.
6. **Drain Valve Handle (Blue)** - Pull to drain frypot. Push in close drain valve.
7. **Filter Pan Cover** - Easily slides out for cleaning.
8. **Filter Pan Assembly** - Holds oil during frypot cleaning and filtering. Contains filter pick up assembly, and pick up tube
9. **Cooking Computer** - Controls frypot temperature, and provides cook time tracking.
10. **Filter Soon Indicator (RED)** - Based on cooking loads, lights to indicate a frypot should be filtered.
11. **Cook Load Counter Selector** - Used to establish filtering frequency.
12. **Gas Valve Shut off Knob**- closes gas off safely at end of day.
13. **Filter Motor Thermal Overload Reset button (RED)** - Press to reset. SEE WARNING BELOW
14. **Drain Outlet** – Swings out to ease shortening disposal.
15. **Pump Strainer** - Prevents debris from jamming filter pump if filter paper rips or is installed poorly.
16. **Filter Pump Circuit Breaker**- Protects pump motor from over current. SEE WARNING BELOW
17. **Frypot High Limit Reset Button** (Shown on page 37) - Press to reset

WARNING

Resetting either the filter pump circuit breaker (item 16), or the filter pump motor thermal overload (item 13) may cause unexpected hot oil discharge if a refill switch or flush hose valve (if equipped) is left in the ON position. Always check that the filter return switches (item 5), or the flush hose valves (if equipped) are OFF before resetting the breaker or thermal overload.

3.3. FILLING THE FRY POT

Only use shortening that is liquid at room temperature in this appliance.

<p style="text-align: center;">CAUTION</p> <p>This appliance is NOT designed for cooking with water. Fill with oil or shortening only.</p> <p style="text-align: center;">WARNING</p> <p>This appliance is not designed for use with solid shortening. Using solid shortening will cause the filter pump and oil lines to become plugged, and require professional service personnel to fix.</p>
--

3.4. FILLING THE TANK WITH LIQUID SHORTENING

To fill the tank with liquid shortening, refer to the following procedure.

FRY POT OIL CAPACITY: SSHLV14 = 30 lbs (13.6 kg)
 SSHLV14T = 17 lbs (6.8 kg)

It is recommended that high quality liquid frying oils be used for longest oil life.

1. Verify that the tank interior is clean and free of any construction debris.
2. Rinse the tank and drain line with a small amount of clean cooking oil.
3. Ensure that the drain valve is closed.
4. Fill the tank to the "MIN" level mark. The oil will expand when heated up, raising the level to OIL LEVEL line.
5. After the cooking oil is at operating temperature, add oil to the frypots as needed to obtain the desired operating level.

<p style="text-align: center;">WARNING</p> <p style="text-align: center;">THE PUSH BUTTON TOP OFF SYSTEM IS NOT INTENDED TO FILL FRY POTS.</p>
<p style="text-align: center;">WARNING</p> <p>Replace shortening that is smoking, or foams when cooking. Old shortenings have reduced flash point, and are prone to surge boiling. Using old shortening may create dangerous conditions</p>
<p style="text-align: center;">WARNING</p> <p>Do not overload the fry baskets, or allow the oil level to exceed the MAX line while cooking. Wet product, or too much oil in the frypot can lead to surge boiling, and over topping the frypot. Overtopping may create hazards such as burns or slippery floors.</p>
<p style="text-align: center;">CAUTION</p> <p>This appliance is NOT designed for cooking with water. Severe equipment damage will occur if a fryer is used as a water bath for rethermalizing foods.</p>
<p style="text-align: center;">WARNING</p> <p style="text-align: center;">Oil must completely cover the heating tubes at all times while appliance is on.</p>

4. APPLIANCE START UP

Refer to the following procedure to start the appliance prior to operation.

1. Ensure that the drain valve is closed.
2. Fill the cook tank with oil/shortening. (See section 3.3 “Filling the Cook Tank”)
3. Light the appliance. (See “Lighting Instructions” section)
4. Turn the controller on. Press the  button to turn the controller on.

Note: If your appliance has a self cleaning burner system, the burners may make a popping sound immediately after the main burners light during startup. This noise during startup is part of the normal operation of the self cleaning burner system and should NOT continue during normal cooking & idle periods. (SCB Only)

5. The appliance is now on and heating the oil/shortening in the cook tank.

<p>WARNING</p> <p>NEVER operate the appliance with an empty fry tank. It will void the warranty.</p>
<p>WARNING</p> <p>Oil/shortening level should NOT be allowed to fall below the minimum indicated level line at any time. Dry firing of the fry tank will shorten tank service life and will void your warranty.</p>
<p>WARNING</p> <p>Oil level should NOT be allowed to fall below the minimum indicated level line at any time. Dry firing of the elements may cause a fire, and can shorten element service life. Evidence of dry firing will void your warranty.</p>
<p>OIL TEMPERATURE</p> <p>Keep the oil temperature in the fryer to a maximum of 190°C (374°F). Higher temperatures will cause rapid breakdown of the oil and give you no faster cooking. At 205°C (401°F) to 210°C (410°F) the life of the oil is only one third of its life at 190°C (374°F). In addition, increased decomposition causes the oil to smoke badly even if the temperature is lowered to 190°C (374°F) again. High temperatures give you no advantage, cost you money and increase the fire danger.</p>
<p>TEMPERATURE DELL'OLIO</p> <p>Mantenere la temperatura dell'olio nella friggitrice fino a un massimo di 190°C. Temperature maggiori causano un rapido degrado dell'olio, senza tuttavia eseguire una cottura più rapida. Da 205°C a 210°C la durata dell'olio è inferiore di un terzo rispetto a quella a 190°C. Inoltre, l'accresciuta decomposizione comporta una forte emissione di fumo, anche se la temperatura viene riportata di nuovo a 190°C. Le alte temperature non prevedono vantaggi, sono antieconomiche e aumentano il rischio d'incendio.</p>
<p>ΘΕΡΜΟΚΡΑΣΙΑ ΛΑΔΙΟΥ</p> <p>Διατηρείτε τη θερμοκρασία λαδιού στη φριτέζα μέχρι 190 βαθμούς Κελσίου. Υψηλότερες θερμοκρασίες θα αλλάξουν τη σύνθεση του λαδιού πολύ σύντομα και δεν ψήνεται γρηγορότερα. Η δυναμικότητα του λαδιού στους 205-210 βαθμούς Κελσίου είναι μόνο το ένα τρίτο της δυναμικότητάς του στους 190 βαθμούς Κελσίου. Επιπλέον η αυξημένη αποσύνθεση του λαδιού, σε θερμοκρασίες πάνω από 190 βαθμούς Κελσίου, κάνει το λάδι να καπνίζει άσχημα κι αν ακόμη κατεβάσετε τη θερμοκρασία κατόπιν πάλι στους 190 βαθμούς Κελσίου. Οι υψηλές θερμοκρασίες δε σας παρέχουν κανένα πλεονέκτημα, σας κοστίζει περισσότερα χρήματα και αυξάνουν τον κίνδυνο πυρκαγιάς.</p>

4.1. COOKING

To ensure the quality of the food you cook in this appliance, follow the preparation instructions from the food manufacturer. When the appliance is not in use, the oil should be cooled and covered to prevent contamination.

WARNING
Dry fired heat tubes are extremely hot, will shorten its service life and will void your warranty.

4.2. COOKING TIPS

- ✓ Always follow the food manufacturer’s directions.
- ✓ The lower the oil temperature, the longer the cooking time and the greater the fat absorption.
- ✓ NEVER overfill fryer baskets. Overfilling can result in soggy, greasy product.
- ✓ When removing baskets from the cook tank, shake gently to remove excess oil.
- ✓ Never leave a basket over the fryer. The heat from the cook tank will continue to cook the product.
- ✓ Oil/shortening quality can effect product quality. Keep salt and water away from the oil/shortening to maintain its life. Oil/shortening filtration removes crumbs from the oil which will also extend its life.

Typical French Fry Cook Times

Fry Thickness	350F (177C)	360F (182C)	370F (188C)
Thin	2:45	2:30	2:15
medium	3:45	3:30	3:15
Thick	4:15	4:00	3:45

This table is for reference only. Please refer to the product manufacturer’s specifications to determine exact cook temperatures and ..

5. COMPUTER CONTROLLER OPERATION

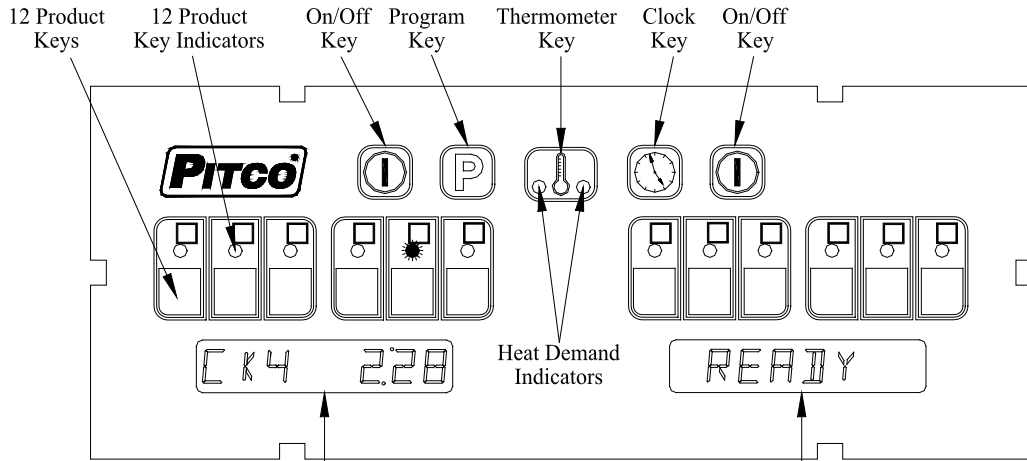

Displays show current operation. Throughout this text, a left only display will be printed as [CK4 2:28]. When both left and right displays should be interpreted together, this text will show them as [CK4 2:28] [READY].

5.1. TO TURN THE APPLIANCE ON:

If power is applied to the appliance, the displays will show [OFF]. Press the [I/O] key. Displays will show one of the normal displays: [HEATING]; [MELTING] [SOLID]/[LIQUID]; or [READY]. Some messages may show in both left and right displays. Wait for the appliance to heat up to the [READY] condition before cooking.



5.2. TO TURN THE APPLIANCE OFF:

Press the [I/O] key. Display will momentarily show the software version number and then [OFF][OFF]. Use the Left [I/O] key for left side and Right [I/O] key for the right of dual vat control 60126802. Either key may be used on the single vat controller.



5.3. TO START A COOK:

When displays are showing [READY] the appliance has reached set temperature and is ready to cook. Press the desired product key, and place product into the vat. The indicator above the product key will flash to indicate the cook timer is running. In the example above, product 4 is cooking with 2 minutes and 28 seconds remaining. The right side display has no running cook timers, and shows [READY].

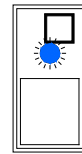

Multiple cooks may run together. While cooks are running, the displays will always show the cook with the least time remaining. Longer running cooks will flash their indicators at a slower rate. Cook time remaining on these keys may be checked by momentarily pressing the product key.

5.4. TO CANCEL A COOK:

Press and hold the product key to cancel a running cook. If no other cooks are pending, controller displays will return to [READY].

5.5. TO VIEW ACTUAL AND SET TEMPERATURES:

To view the actual vat temperature, press the thermometer key. The display will show [ACT nnnF] or [ACT nnnC], where nnn is the current vat temperature. After a few moments, the display will return to [READY], [MELT], or [HEATING] when no cooks are running, or, [CKn mm:ss] for any cooks still running.

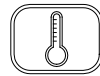

To view the set temperature, press the thermometer key twice. The display will show [SET nnnF] or [SET nnnC], where nnn is the current set temperature. After a few moments, the display will return to [READY], [MELT], or [HEATING] , or, [CKn mm:ss] for a cook still running.



5.6. TO VIEW CURRENT SETTINGS FOR COOK, SHAKE, AND HOLD TIMES:

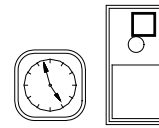

To view the current settings for any product key, press the clock key, followed by the desired product key.

The display will show [CKn mm:ss], followed by [SHn mm:ss], then [HDn mm:ss]. Where “n” is the key number, and “mm:ss” are the current settings for time. After a few moments, the display will return to [READY], [MELT], or [HEATING] , or, [CKn mm:ss] for a cook still running.

Typical displays using key 4 as an example:

Key 4 set for 3 minutes and 28 seconds cook time.



Key 4 Shake Time is set for 2 minutes and :00 seconds before the end of the Cook.



Key 4 Hold Time in set for 10:00 minutes.



In a few moments, the display will return to [READY]

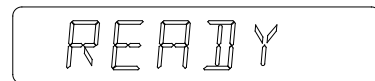

5.7. TO PERFORM A BOIL OUT OPERATION:

Normal maintenance of a fryer requires regular tank cleaning. This process involves draining the vat of oil and filling with water.

Cleaning solution is added, and the control is set to the boil out mode by one of the following methods:

5.7.1. AUTOMATIC BOIL ENTRY (WATER DETECTION):

After filling an empty vat with water, turn the appliance On. Heat will be applied to the vat warming the water. This control will detect the presence of water by temperatures not rising above the boiling point of water; 212°F (100°C). After a time at this temperature, displays will show:



Heat will be disabled until the operator responds to this prompt. Pressing the [0] key is a **YES** response to the boil prompt. If pressed, display will show:

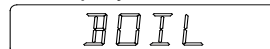

Heat will maintain vat temperature at 185°F (85°C) for cleaning as long as the control remains on. To exit boil mode control must be turned off.

Warning: Pressing any other key at the [PRESS 0] [TO BOIL] prompt is regarded by the control as a **NO** response. With this response, the control will apply heat to the vat as if oil were present in the vat. With water in the vat, a rolling boil will result. This will cause undesirable foam over conditions, and steam burn hazards to operators performing cleaning operations.

5.7.2. MANUAL BOIL ENTRY:

After filling an empty vat with water, turn the appliance on. Press the thermometer key and enter key sequence [2], [1], [2]. *If control is set to display in the Celsius scale, press [1], [0], [0] keys to manually enter boil mode.* The display will show [BOIL] to indicate entry into boil mode. To exit boil mode, control must be turned off.

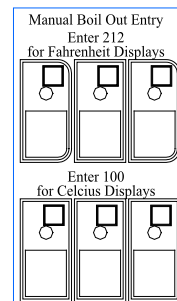

5.8. TO ENTER PROGRAMMING LEVEL 1 (FOR THE STORE MANAGER):

Note: The factory default setting for this control does not require an operator password to be entered. However, the operator password requirement and value may be changed in (See section 4.12 “To Enter Programming Level 2” (For the Store Manager). This text assumes the operator password is disabled. Entry of a password when NOT required will not interfere with the programming process.

With no cook timers running, displays will show one of the following displays: [HEATING], [MELT] [LIQUID (or SOLID)], or [READY].

Press the [P] program key. Left display will show [PROGRAM]. Right display will be blank.

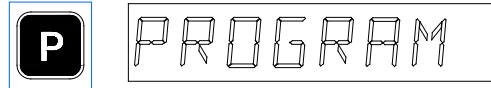

Enter password 6684 using the product keys as numeric keypad for entry.

Display still shows [PROGRAM].

From the [PROGRAM] display, continue with this section or go to section 3.

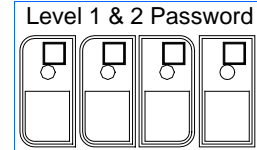

5.9. TO SET COOK TEMPERATURE:

Press “P” key then press the thermometer key once for Single Vat (left side of Dual Vat) or press key twice for Dual Vat (right side of Dual Vat).

The display will show [SET xxxF] [TEMP] or [SET xxxC] [TEMP], where “xxx” is the temperature setting. Use the product keys for numeric entry to adjust the current setting. Press the [P] key to save setting. Display now shows [PROGRAM]. To exit here, press [P] again, or continue.



5.10. TO CHANGE A PRODUCT KEY–COOK, SHAKE, HOLD, AND HOLD PRE-ALARM TIMES:



For each product key, Cook, Shake, Hold, and Hold Pre-alarm times are set in this section. With display showing [PROGRAM], continue with the following section for each product key to change.

5.10.1. COOK TIME

Cook Time may be set for each product key. To deactivate any product key enter a zero value for cook time.

Press the [Clock] key. Display will show [SELECT] [PRODUCT]. Press the desired product key to change.

The display is now showing [nCK mm:ss] [TIME] where “n” is the key number, “CK” means Cook, and “mm:ss” is minutes and seconds. Use the product keys for numeric entry to adjust the current setting. Press the [Clock] key to save cook time and continue setup for this product key.



5.10.2. SHAKE TIME

Shake time is an alarm that sounds during Cook Time to prompt operators to shake the basket. Default for this value is zero, meaning the Shake Time is inactive. To use Shake Time, time value must be a non-zero value, and must be set to a value less than cook time.

Display shows [nSH mm:ss] [TIME] where “n” is the key number, “SH” means Shake, and “mm:ss” is time in minutes and seconds.

Use the product keys for numeric entry to adjust the current setting. Press the [Clock] key to save shake time and continue setup for this product key.



Note: Cook Time minus DisplayShake Time = Shake Value Entry, Example: 3:00 cook time with a 2:00 shake time, the value you enter would be 1:00 minute.

5.10.3. HOLD TIME

Cooked product may stand in holding bins for a period of time. This timer produces an alarm to inform operators to discard old product and start a new cook. Default for this value is zero, meaning the Hold Time is inactive.

Display is showing [nHD mm:ss] [TIME], where “n” is the key number, “HD” means HOLD, and “mm:ss” is minutes and seconds.

Use the product keys for numeric entry to adjust the current setting. Press the [Clock] key to save hold time and continue setup for this product key.



5.10.4. HOLD PRE-ALARM

Hold Pre-Alarm is a timer setting that is used to warn operators that the Hold Time is about to expire. To use Hold Pre-Alarm, time value must be a non-zero value, and must be set to a value less than Hold Time. Default value is zero, meaning the Hold Pre-Alarm is inactive.

Display is showing [nPA mm:ss] [TIME] where “n” is the key number, PA means Pre-Alarm, and “mm:ss” is minutes and seconds.

Use the product keys for numeric entry to adjust the current setting.

Press the [Clock] key to save cook time and continue setup for this product key.

Note: Value entered for Hold pre-alarm time is the hold time minus the pre-alarm time. Example: 15:00 hold time with a 5:00 prealarm time, the value you enter would be 10:00 minutes.



Display will again return to [SELECT] [TIME]. Repeat steps from 1 to make changes to any other product keys or continue.

5.11. TO EXIT LEVEL 1 PROGRAMMING:

Display shows [SELECT] [TIME]. Continue to make changes or exit here in next step.

Press the [P] key.

Display shows [PROGRAM].

To exit Level 1 programming, press the [P] key again.

Displays will show [HEATING], [MELT] [LIQUID (or SOLID)], or [READY].



5.12. TO ENTER PROGRAMMING LEVEL 2 (FOR THE STORE MANAGER)

The display must show [PROGRAM] from (See section 4.8 “To Enter Programming Level 1” (For the Store Manager). to change these options. When the product key [0] is pressed, the display will show [SELECT] [OPTIONS]. Indicator lights above product keys will illuminate to represent options that may be changed. Each option listed below uses the product key [0] to toggle or scroll through available choices in the display. When the correct value is displayed, press the [P] key to save choice. The display will again return to [PROGRAM] for another option selection.

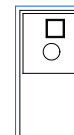

5.13. FAHRENHEIT OR CELSIUS DISPLAY:

The Controller will display temperatures in the Fahrenheit or Celsius scales. The default scale is °F. With display showing [PROGRAM], press the product key [0].

Display shows [SELECT] [OPTIONS].

Press product key 1, display shows [DEGREE n] [F OR C], where “n” is the current setting.

Use the product key [0] to scroll through choices (F or C). Press [P] key to save choice.

Display shows [PROGRAM].

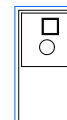

5.14. PASSWORD CHANGE OR REQUIRED?

With factory settings, an operator password is not required to enter programming Levels 1 and 2. The password may be activated or changed in this section.

With display showing [PROGRAM], press the product key [0]. Display will show [SELECT] [OPTIONS].

Press product key 2, display shows [SET PASS] [NEW PASS]. Use the product key [0] to scroll through choices [NO PASS] or [PASS REQ]. Press [P] key to save choice.

If [NO PASS] is selected Display returns to [PROGRAM].

If [PASS REQ]. is selected, display will show [PASSnnnn] [NEW PASS] to prompt for new password. Displayed value “nnnn” is the current password. Use the product keys for numeric entry to change password. Press [P] key to save choice. Display shows [PROGRAM].

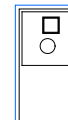

Note: The factory default password (6684) will always work even if a different password is selected above.

5.15. BEEPER VOLUME AND TONE:

Volume and Tone of the beeper alarm may be changed in this section. Volume ranges are 1,2 and 3, where 3 is the loudest setting.

With display showing [PROGRAM], press the product key [0].

Display will show [SELECT] [OPTIONS]. Press product key 3, display shows [VOLUME n] [BEEPER]. Use the product key [0] to scroll through choices (n= 1,2,3, or T). Beeper volume will change as each selection is made.

If "T" is selected an additional display is shown, [TONE n] [BEEPER]. Use the product key [0] to scroll through choices (n= 1,2,3). Beeper tone will change as each selection is made. Press [P] key to save choice. Display shows [PROGRAM].

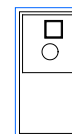

5.16. LANGUAGE SELECTION:

With display showing [PROGRAM], press the product key [0].

Display shows [SELECT] [OPTIONS].

Press product key 4, display shows [ENGLISH] [LANGUAGE].

Use the product key [0] to scroll through choices (ENGLISH, ESPANOL, FRANCAIS, DEUTSCH, HOLLAND).

Press [P] key to save choice. Display shows [PROGRAM].

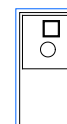

5.17. MELT CYCLE TYPE:

This adjustment allows selection of the melt cycle type, or, disabling the melt cycle requirement when starting the appliance from a cold start.

With display showing [PROGRAM], press the product key [0].

Display will show [SELECT] [OPTIONS].

Press product key 5, display shows [LIQUID], the default setting.

Use the product key [0] to scroll through choices (liquid, solid, no melt).

Press [P] key to save choice. Display will again return to [PROGRAM].

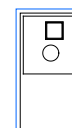

5.18. RECOVERY TEST VALUE:

This controller maintains a record of heat up times for the appliance. A poorly running appliance will have increased recovery times stored in this display. There is no selection done here, just the display of recovery time values.

With display showing [PROGRAM], press the product key [0].

Display shows [SELECT] [OPTIONS].

Press product key 6; display will show [RECOVERY] [TEST].

Press the product key [0]. Display will show [FnnnLyyy], where nnn is the factory recovery value, and yyy is the last warm up recovery value.

After recording these values, press the [P] key. Display returns to [PROGRAM].

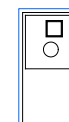

5.19. CONTROL OR TIMER: (LEFT SIDE OF DUAL OR SINGLE VAT)

With display showing [PROGRAM], press the product key [0].

Display shows [SELECT] [OPTIONS].

Press product key 7; display will show [CONTROL].

Use the product key [0] to scroll through choices (Control, Timer).

Press [P] key to save choice. Display shows [PROGRAM].

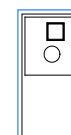

Note: If timer is selected, heat control outputs are disabled, leaving only the timer functions active. Do not make this selection on SSHLV fryer models.

5.20. CONTROL OR TIMER: (RIGHT SIDE OF DUAL VAT)

Note: This key has no function of single vat controls.

With display showing [PROGRAM], press the product key [0].

Display shows [SELECT] [OPTIONS].

Press product key 8; display will show [CONTROL].

Use the product key [0] to scroll through choices (Control, Timer).

Press [P] key to save choice. Display shows [PROGRAM].

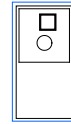

Note: If timer is selected, heat control outputs are disabled, leaving only the timer functions active. Do not make this selection on Solstice fryer models.

5.21. OTHER DISPLAYS:

[PROBE OP] [OPEN]

Open probe detection is standard on all Pitco controls. If probe is detected open, normal heating and cooking activities are suspended.

[HIGH TMP] [HIGH TMP]

This display warns operators that the vat temperature has exceeded set temperature by 40°F (22°C), or an absolute maximum of 410°F (210°C). This display does not show the status of the mechanical high limit switch.

[DRAINING] [TURN OFF]

This message indicates that the drain valve has been opened, the vat is assumed to be empty by the controller. Normal heat control activities are suspended. To restore to normal operation, close the drain valve. Display will show [TURN OFF] [TURN OFF].

Turn controller off, and refill the vat. Continue with normal operations at (See section 4.6).

[HEAT] [FAILURE] OR [IGNITION] [FAILURE]

This message indicates that the heating system failed to respond. Typically, the high temperature limit switch has tripped and is in need of resetting. In the case on gas fired appliances, this message will display if the pilot fails to light or is detected marginal by the ignition module.

[SYSTEM] [FAILURE]

This message indicates a shorted probe. If probe is detected as a short circuit normal heating and cooking activities are suspended.

5.22. COMPUTER SHUTDOWN

Press and hold the computer control  button to turn the fryer OFF. Refer to section 6.5 for complete appliance shutdown instructions.

5.23. FLUSH HOSE OPERATION (IF EQUIPPED)

The cooker tank can be rinsed cleaned by using a filter flush hose (if equipped). Refer to the following procedure to operate the filter flush hose.

1. Turn the appliance OFF.
2. Pull the blue drain handle down to drain oil/shortening from the cooker tank into the filter pan.
3. Connect the filter flush hose to the quick connecting fitting.
4. Point the filter hose nozzle outlet into the cooker tank.
5. Pull the yellow handle to turn the pump on and allow oil/shortening to flow through the flush hose.
6. To refill the tank, lift the blue drain handle up.
7. When the tank has completed filling, push the yellow handle to deactivate the pump.

6. BASKET LIFT OPERATION

If the appliance is equipped with basket lifts, place the basket onto the basket lift prior to starting the timer(s). The basket(s) will be lowered into the cook tank when a product key is pressed. At the end of the preset cooking time, the basket lift will raise the basket out of the cook tank.

7. PUSH BUTTON OIL TOP OFF SYSTEM

Refer to the following procedure to perform easy cooking oil replenishment.

It is not intended for filling the frypot.

(If yellow light comes on for LOW OIL BOTTLE it indicates that oil jug is getting low.)

1. TOP OFF LOW FRYPOT. Press and hold switch to replenish frypot oil as needed.
2. Remove oil jug from oil jug holding compartment provided (except on Solofilters) Insert cap assembly hose until cap rests on edge of jug. Return to cabinet.

LOW BOTTLE LIGHT



FRYPOT TOP OFF SWITCH

8. AUTOMATIC OIL TOP SYSTEM (OPTION)

Pitco offers the “Automatic Oil Level Control” option (Auto-Top Off) to maintain the optimal oil level in your Pitco fryer. This optional system minimizes the need for the operators attention during busy cooking hours. The system maintains oil levels in the frying vat by adding small amounts of fresh oil when appropriate. Replenishment oil is drawn from a Jug In Box (JIB) located in one of the cabinets in a multiple vat build. Alternately, the JIB can be remotely located within nine feet of the fryer. The system can also accommodate a bulk oil system.

The Oil Level Driver Board (OLDB) works with the Filter Control Board (FCB) to maintain proper cooking oil levels. An optional “Manual Fill Switch” to allow operators to add fresh oil at their discretion can also be supplied.

Fresh oil is added to a low vat by using the same pump that is used for filtering. Because the pump has multiple purposes (filtering and topping off the vat), the Filter Control Board (FCB) will prevent the any “top off” event during filtering.

The system’s “Oil Level Drive Board” samples the oil level probe continuously and determines when to add fresh oil to the vat. The “Enable Input” allows a top off event only when it’s appropriate.

There are specific conditions when fresh oil will not be added to the vat by the automatic system:

- 1) Cook Cycle
- 2) Heating Cycle
- 3) Melt Cycle
- 4) Filtering Cycle
- 5) Control in the “OFF” state

The “Enable Input” is active only when the cooking control is at cooking temperature *and* an idle condition. Typically the cooking control displays “READY” or “DROP” when idle. Without the “Enable Input” active, the “Oil Level Drive Board” will not top off the fry vat.



9. QUICK STRAIN FILTERING “Filter Soon” light flashing

(**WARNING:** Turn OFF Fryer, before filtering. Wear oil proof, insulated gloves while filtering.)
Refer to the following procedure for quick strain filtering.

FILTER SOON LIGHT. Flashing indicates the need to perform a “Quick Filtering” as soon as business levels permit.

1. TURN Fryer OFF. Pull BLUE drain handle to drain oil from fry tank.
2. PRESS FILTER RETURN switch to ON to turn pump on.
3. Rinse fry pot 30 seconds. Use brush to clear debris through drain. Push BLUE handle in.
4. When bubbles appear in oil, turn FILTER RETURN switch to OFF.
5. Only filter 1 frypot at a time, the filter pan may overflow.



10. COOK COUNTER ADJUSTMENT

The Pitco SSSLV14 is a Low oil volume fryer. Low oil volume fryers have smaller cold zones than standard fryers, and may require filtering during the cooking day. Excessive sediment levels in the bottom of the frypot, can cause shortening to break down prematurely. The cook counter makes it easy to know when to filter each fryer. Quick filtering as often as possible is an easy way to insure the benefit of longest possible shortening life.

It is necessary for managers to determine filtering frequency on a fryer by fryer basis to prevent sediment build up. Once you have determined how many loads of various products can be cooked without over filling the bottom of the fryer, set the cook counter to that number. In general, products which create a small amount of sediments, can use higher numerical settings. Foods with high breading fall off, use lower numbers.



1. Use a flat screwdriver to remove cover.
2. Set selector knob based on products cooked in this fryer. Depending on sediment fall off select from 1-15. (light fall off products=15), (heavy fall off products=1).
3. Replace cover.

11. APPLIANCE SHUTDOWN

There are two shutdown modes of appliance operation: STANDBY and COMPLETE. The standby mode removes the ability of the appliances main burners to operate. Complete shutdown turns off the gas supply to the appliance. Refer to the following procedures to enter the appropriate shutdown mode.

11.1. STANDBY MODE

Press and hold the * button to turn the computer OFF.

11.2. COMPLETE SHUTDOWN

1. Press and hold the * button to turn the computer OFF.
2. Turn the ON/OFF knob on the gas valve clockwise to the OFF position
3. The appliance is now completely shut down and can be cleaned if desired.

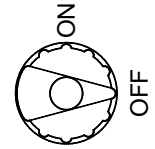

Matchless Ignition

12. PREVENTATIVE MAINTENANCE

12.1. DAILY PREVENTATIVE MAINTENANCE

Performing the preventative maintenance steps below on a daily basis will keep your equipment safe and at peak performance. During the cooking process, oil/shortening may spill and splatter and requires immediate attention. Furthermore, during the cooking process, particles, crumbs and crackling collect inside the cooker tank reducing product quality and decreasing oil/shortening life. If you are producing high quantities of fried food and/or frying heavily battered food, it may be necessary to perform these steps more than once a day.

WARNING

Serious injury could result from direct contact with hot surfaces and/or oil. Always wear apron, heat resistant gloves for skin protection and goggles for eye protection

12.1.1. FILTERING DAILY CLEANING

At least daily, a complete filter is required. Make sure a clean filter is installed every day.

1. Turn the appliance OFF. Pull the blue drain handle to drain oil/shortening from the cooker tank into the filter pan.
2. Using a water dampened clean cloth, wipe the insides of the fry pot to remove crumbs and debris. Scrub crumb ring in frypot with abrasive pad if needed.
3. Press the FILTER RETURN switch to turn the pump on to circulate oil/shortening through the filter media. Recommend allowing the oil to recirculate for 5-10 minutes
4. To refill the tank, push the blue drain handle in.
5. When the tank has completed filling, press the FILTER RETURN switch to deactivate the pump.
6. Assure that the oil/shortening level is above the minimum level line. Additional oil may need to be added to the cook tank.
7. The oil/shortening in the fryer has now been filtered.
8. Replace the filter media and clean the filter pan following the procedures mentioned in this manual.

12.1.2. REPLACING THE FILTER MEDIA (IF EQUIPPED)

Refer to the following procedure to replace the filter media if the appliance is equipped with a filter drawer.

1. Detach the pickup tube from the filter pickup assembly by unscrewing it (counterclockwise), at the knurled fitting, from the threaded fitting on the filter screen.
2. Slide off the filter paper clip and remove used filter paper from filter screen. Replace with new filter paper, ensuring that the hole in the paper is on the top, so that threaded fitting in filter screen protrudes through it.
3. Fold filter paper to the underside of the filter screen and replace filter paper clip.
4. Re-attach filter pickup tube to the filter screen by screwing it (clockwise) into the threaded fitting in filter screen.
5. Reinstall the filter pickup assembly into the filter system by placing the newly covered screen portion of the assembly into the filter pan and connecting the quick disconnect on the filter pickup assembly into white donut fitting on the left-hand side of the appliance. Ensure that it snaps tightly and securely into donut fitting.

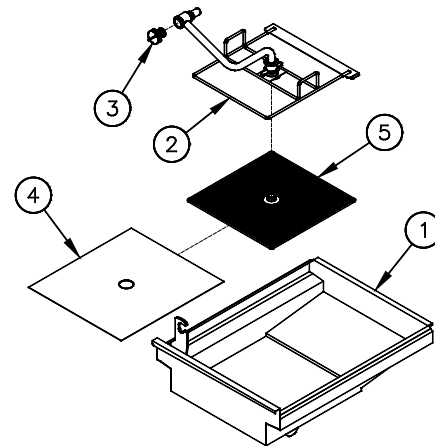

1. Filter Pan
2. Filter Pickup Assembly
3. Filter Strainer Cap
4. Filter Paper
5. Filter Screen

WARNING

The power supply must be disconnected before cleaning and servicing this appliance!

WARNING

The contents of the crumb catch and/or filter pan of any filter system must be emptied into a fireproof container at the end of the frying operation each day. Some food particles can spontaneously combust into flames if left soaking in certain oil/shortening materials.

12.1.3. APPLIANCE INSPECTION

- ✓ Check that the high temperature limit and temperature probe are in the correct position and secured in place.
- ✓ Check that wires and cords are not frayed or loose in and out of the cabinet.
- ✓ Check around the appliance for loose parts or accessories that need to be secured or other foreign items (ex: Aerosol cans) that should be removed from the area.
- ✓ Check for oil/shortening leaks around the inside and outside of the cabinet and around the appliance.

WARNING Serious injury could result from direct contact with hot surfaces and/or oil. Always wear apron, heat resistant gloves for skin protection and goggles for eye protection
WARNING Read the operation section of this manual prior to filling or operating the appliance.
WARNING DO NOT leave the appliance unattended during cleaning.

12.1.4. CLEANING THE COOK TANK

1. Turn the appliance off. Drain all the oil/shortening from the tank and allow the tank to cool.
2. Remove baskets, tank rack and basket hanger for cleaning.
3. Using the cleaning brush, remove all the loose debris and scrub all tank surfaces.
4. For tougher carbonized oil/shortening and carbon buildup scrub tank using a Scotchbrite or other abrasive pad.
5. Wipe residue with a clean damp cloth and carefully dry any remaining oil/shortening droplets from the tank before returning oil/shortening into the tank.
6. Clean and dry baskets, tank rack and basket hanger before reinstalling.

12.1.5. CLEANING THE CABINET

1. Wipe any spilled oil/shortening, dust and lint from the cabinet exterior with a clean damp cloth and a mild food grade detergent .Be careful not to get any water or detergent in the oil/shortening. Use a nonabrasive pad for tougher stains if needed.
2. Remove detergent from all surfaces.
3. Cleaning the interior cabinet requires a clean cloth to remove any oil/shortening, dust, lint or filter powder (i.e.: Magnesol) from the interior of the cabinet.

12.1.6. FILTER CLEANING (IF EQUIPPED)

1. Unscrew filter strainer cap from pickup tube and gently tap it to dislodge any crumbs from the slots. Use a clean cloth to remove any remaining crumbs and reattach.
2. Scrape all loose debris and crumbs from filter pickup assembly and filter pan with the filter scoop shovel.
3. Remove filter pickup and place in pot sink, power soak sink or dishwasher for cleaning. Be sure to rinse thoroughly and dry all surfaces before re-assembly.

4. Wipe the filter pan with clean damp cloth and a food grade detergent. If necessary place pan in pot sink to rinse all the detergent from the surfaces and dry all surfaces before re-assembly.

12.2. WEEKLY PREVENTATIVE MAINTENANCE

Performing the preventative maintenance steps above on a daily basis will keep your equipment clean and safe. On a weekly basis these additional steps should be performed.

1. Turn the fryer off. Allow the oil/shortening to cool to before pulling the fryer away from the hood.
Hint: This maintenance may be ideal to perform on the day the oil/shortening is being changed so no oil/shortening is present in the tank or filter.
2. Disconnect the power cord(s), gas hose, and retention lanyard.
3. Wearing your protective gear, pull the fryer away from the hood.
4. Check that vent hood drip cup is empty and not dripping oil/shortening into the flue.
5. Check that the hood baffles are clean and not dripping oil/shortening into the flue.
6. Clean the fryer sides, back and the flue area, it may be necessary to use a non-abrasive pad to scour and a putty knife to scrape the oil/shortening buildup. With a clean damp cloth and food grade detergent wipe the area clean.
7. Wipe up any excessive oil/shortening on the power cord(s) and gas hose with a dry cloth.
8. Check flue pipe for any foreign debris/object and remove if found.
9. Reattach power cord(s), gas hose, retention lanyard and push fryer back under the hood.

12.3. MONTHLY PREVENTATIVE MAINTENANCE

Food debris and oil/shortening can buildup inside the tank. Performing the monthly preventative maintenance steps below will keep your equipment safe and at peak performance. If you are producing high quantities of fried food and/or frying heavily battered food, it may be necessary to clean these components more than once a month.

12.3.1. BOIL OUT PROCEDURE

Wear protective gloves and clothing when cleaning and draining the appliance. Oil/shortening may spatter and will cause injury to personnel.

1. Read the "operation" section of this manual prior to filling or operating the appliance.
2. Turn the appliance off. Drain all the oil/shortening from the tank and allow the tank to cool. The container must also be able to withstand 400°F (205°C) temperatures.
3. Remove baskets, tank rack and basket hanger for cleaning.
4. Remove and discard any large debris inside the tank.

5. Close the drain valve and fill the tank with potable water to the level lines.
6. Place the appliance into boil mode:

Turn the appliance ON. The controller will recognize that there is water in the tank and automatically enter boil mode. To enter boil mode manually, press the Temp Key then keys 2, 1, 2 for degrees F or 1, 0, 0. for degrees C.
7. Once the water reaches a simmer, add 8 to 10 ozs (227 to 283 g) of Pitco cleaner for every 25 lbs (11.3 kgs) of oil/shortening your fryer is rated to hold.
8. Simmer for 1 minute. (The water should never be allowed to boil as this may splash over the tank side and cause permanent damage to the components.)
9. Turn the appliance OFF and allow the fryer to soak for 15 to 30 minutes, allowing the cleaner to soften the oil/shortening deposits and carbon.
10. Scrub the inside of the tank using a cleaning brush safe for hot water. Care must be taken to remove all the foreign material on the tank, heating tubes, sidewalls and other components in the tank.
11. Drain the water from the tank.
12. Once the tank has cooled, rinse with clean potable water thoroughly.
13. Remove all remaining water and residue with a clean dry cloth.
14. Clean and dry baskets, tube rack and basket hanger before reinstalling
15. Close the drain valve and fill the cooker tank with oil/shortening.

12.3.2. TEMPERATURE CHECK

1. Use a high grade pyrometer or digital thermometer suitable for temperature up to 380°F (182°C). Place the thermometer in the oil above the tip of the fryer's temperature probe with in 1" (2.54 cm) 25.4 mm). Be sure not to touch the heat tube since this will measure incorrect temperatures. Allow several minutes for the thermometer to equilibrate with the oil temperature.
2. Press the Thermometer key on the computer, and compare the actual temperature to the thermometer reading.
3. The two readings should be within +/-5° of each other.

12.4. ANNUAL/PERIODIC PREVENTATIVE MAINTENANCE AND INSPECTION

This section should ONLY be performed by a qualified service technician as part of a regular kitchen maintenance program. This inspection should take place a minimum of once a year by an Authorized Service Technician recommended by Pitco. It may be necessary perform this inspection more than once a year.

WARNING

The power supply must be disconnected before cleaning and servicing this appliance!

12.4.1. SAFETY EVALUATION

- ✓ Check power cord and plug.
- ✓ Check all exposed wiring connections, switches, and indicator lights.
- ✓ Check legs, casters, wheels, plate welds and ensure all nuts and bolts are secured.
- ✓ Check conditions of flexible gas line and verify fryer retention / lanyard system is in place.

12.4.2. MECHANICAL INSPECTION

- ✓ Check frypot for shortening leaks and excessive oil build up
- ✓ Check for oil migration (Clean as required)
- ✓ Check hood drain cup, ensure it is empty and not dripping into the flue.
- ✓ Check hood baffle for clean surface, oil/water condensate can drip on and into the flue.
- ✓ Check flue for foreign debris and hood down draft currents.
- ✓ Check drain/filtration system (if equipped) for leaks
- ✓ Check for missing fryer parts, i.e.: cover strips
- ✓ Check for missing fasteners

12.4.3. TEMPERATURE CONTROL SYSTEM

- ✓ Check electrical connections and harnesses
- ✓ Check temperature probes and limits for carbon build up and plating. Clean as required
- ✓ Check proper mounting of probes and sensors and all fasteners are secure.
- ✓ Check thermistor probe resistances for stability.
- ✓ Check DVI Drain Valve Interlock drops out controller.
- ✓ Check Controller/thermostat features to ensure they are functioning.
- ✓ Check Temperature Calibration

12.4.4. FILTER SYSTEM (IF EQUIPPED)

- ✓ Check electrical connections and harnesses.
- ✓ Check IEC power cords are fully engaged and secure.
- ✓ Check for any air or shortening leaks and for excessive oil build-up.
- ✓ Check O-Ring on filter pickup tube and replace as needed.
- ✓ Check filter strainer on pickup tube.
- ✓ Check operation of drain valve and DVI drain valve interlock.
- ✓ Check operation of return oil valve and its pump switch.
- ✓ Check operations of flush hose quick disconnect (if equipped), clean and lubricate as needed.
- ✓ Check all hardware in filter pan.
- ✓ Check filter operation by filtering the fryers.
- ✓ Check pump motor amp draw compare to nameplate amperage.
- ✓ Check pump and motor, clean any excess oil from pump assembly.
- ✓ Check all filter hoses for leaks and integrity.

12.4.5. GAS COMBUSTION SYSTEM

- ✓ Check for gas leaks.
- ✓ Check and clean vent tube on gas valve pressure regulator.
- ✓ Check burners, clean debris and grease from pilot and pilot orifice tips.
- ✓ Check self cleaning burner system (if equipped) that it activates when the appliance is turned on and NOT during normal cooking & idle periods.
- ✓ Check and adjust burner manifold gas pressure to nameplate reading.
- ✓ Check incoming gas pressure when all gas appliances are on.
- ✓ Check ignition system and adjust pilot flame as required.
 - Check flame sensor reading.
 - Check gap spacing and clean igniter.
- ✓ Recheck for gas leaks after inspection.

12.5. VENTILATION HOOD

Proper ventilation hood operation is very important for the correct operation of this appliance and the safety of personnel. The ventilation hood should be inspected at the time of installation of this appliance to insure that it will operate properly in conjunction with the appliance. A regular schedule of examination, in accordance with ANSI/NFPA 96 latest edition and/or local codes must be followed.

13. TROUBLESHOOTING

13.1. POWER FAILURE

If electric power is removed for any reason, the appliance will shut down.

Wait five minutes after the power is restored before attempting to restart the appliance. This will allow time for any gas that may have accumulated in the burner or tubes to dissipate.

To restart the appliance, follow the appliance start up procedure in section 2.2.

CAUTION
DO NOT attempt to operate this appliance during a power outage.

13.2. HIGH TEMPERATURE LIMIT SWITCH

This appliance is equipped with a high temperature limit switch. The high temperature limit switch will stop the appliance from functioning if the oil temperature in the cook tank reaches an unsafe temperature. In the event that the high temperature limit has tripped, please refer to the following procedure to reset the switch.

- a. Turn the appliance off.
- b. Allow the appliance ample time to cool to room temperature.
- c. Add oil/shortening to the cook tank as needed.
- d. Press the high temperature reset button.
- e. The high limit switch is now reset and the appliance is ready for start up.



WARNING
DO NOT add oil/shortening to the tank until it has been given ample time to cool down. Failure to do so may result in damage to the appliance and/or injury to the operator.

13.3. DRAIN VALVE INTERLOCK

Your appliance is equipped with a drain valve interlock circuit, the appliance will stop heating if the tank drain valve is opened. The appliance will turn off, and scroll a message “DRN TRN OFF”. Refer to the following procedure to resume operation after the drain valve interlock is tripped.

1. Turn the computer OFF (if not already OFF).
2. Close the tank drain valve and fill the tank with oil/shortening.
3. Turn the computer ON.

13.4. SELF CLEANING BURNER SYSTEM (NOT ON ALL MODELS)

If your appliance is equipped with the self cleaning burner system, the appliance should behave as outlined in the table below. A cleaning cycle will execute every time the appliance is turned “ON” from an “OFF” state. The thermal cut out switch is designed to disable the appliance if the Self Cleaning Burner System malfunctions and remains activated for an extended period of time or if there is a downdraft into the flue or a blocked flue situation.

Event	Duration	Indication
Turn appliance “ON”	N/A	Control illuminates, pilot sparks and ignites. Pre-Purge pulse is initiated.
Pre-Purge Pulse	2 seconds	Appliance operates briefly and stops. Pilot remains lit.
Interwaiting period 1	5 seconds	Appliance does not operate. Pilot remains lit.
Cleaning Pulse	6 seconds	Main valve operates, lighting main burners. SCBS valve operates, feeding gas to the SCBS Arm. The SCBS arm ignites, initiating a brief burn at the main burner orifice of each burner.
Interwaiting period 2	8 seconds	The Main and SCBS valves de-energize for this period. The pilot remains lit.
Normal operation resumes	N/A	The appliance operates normally and begins to heat up. The SCBS Valve remains de-energized until power to the appliance is recycled. There is no flame on the SCBS Arm. There is no burn at the main burner orifices.

13.5. RESETTING THE SELF CLEANING BURNER SYSTEM TEMPERATURE LIMIT SWITCH

1. Turn the appliance off.
2. Allow the appliance ample time to cool to room temperature.
3. Press the SCBS high limit reset button. The reset button is located behind the front panel at the top of the main burners.
4. The SCBS high limit switch is now reset and ready for startup.
5. If the SCBS high temperature limit switch continues to trip, have the appliance inspected by an Authorized Professional.

13.6. TROUBLESHOOTING CHARTS

13.6.1. FRYER TROUBLESHOOTING CHART

Problem	Probable Causes	Corrective Actions
Controller does not activate.	No power to appliance.	Check main building power supply.
	Controller not turned on.	Turn on controller.
	Power Cord loose or not connected.	Connect power cord.
	Main circuit breaker to appliance has tripped.	Reset circuit breaker
Controller is on and appliance will not heat up.	Appliance fuse has blown.	Contact Authorized Service Company.
	High temperature limit has tripped.	Allow appliance to cool and reset High temperature limit.
Appliance will not maintain temperature properly.	SCBS thermal limit switch has tripped.	Depress button on thermal limit switch to reset. If problem continues, Contact Authorized Service Company.
	Faulty temperature probe.	Contact Authorized Service Company.
Appliance will not maintain temperature properly.	Faulty High temperature limit.	Contact Authorized Service Company.
	Faulty computer	Contact Authorized Service Company.
Computer display shows off and can not be turned on.		

13.6.2. FILTER TROUBLESHOOTING CHART (IF EQUIPPED)

Problem	Probable Causes	Corrective Actions
Filter pump does not activate.	Filter pump circuit breaker or thermal overload has tripped.	Reset circuit breaker/ allow motor to cool, press RED reset button on motor.
Oil/shortening is returning to the tank slowly or not at all.	Dirty filter paper	Change filter paper.
	Strainer cap dirty	Remove strainer cap and clean.
	Filter pan not pushed in completely.	Push filter pan in.
Excessive air bubbles are in the oil being returned to the tank.	Pickup tube screen not tight.	Tighten pickup tube screen cap.
	Pickup tube screen cap missing	Locate and install pickup tube screen cap.
	Filter pan not pushed in completely	Push filter pan in to complete connection.
Drain valve is closed, but the computer controller still displays "DRAINING"	Blue drain valve handle not completely closed	Verify that drain valve handle is completely closed.
	Improperly adjusted or defective drain switch.	Contact Authorized Service Company.

13.6.3. COMPUTER & DIGITAL CONTROLLER DISPLAYS (IF EQUIPPED)

If your appliance is equipped with a computer or digital controller it may display the following messages on its display.

Display	Problems	Action
OFF	Controller is OFF	Press [I/O] key to turn controller ON
MELTING LIQUID	Oil/shortening temperature is low. Fryer is slowly heating.	Wait for appliance to heat up.
MELTING SOLID	Oil/shortening temperature is low. Fryer is slowly heating.	Wait for appliance to heat up.
HEATING	Oil/shortening temperature is low. Fryer is heating.	Wait for appliance to heat up.
READY	Oil/shortening is at temperature and ready to cook.	Perform cooking activities as needed.
DRAINING TURN OFF	Drain valve is open while controller is on.	Turn off appliance. Close drain valve before turning appliance back on.
HEAT FAILURE	Ignition system has locked out.	Refer to Fryer Troubleshooting section
PROBE OP OPEN	Incorrect probe reading.	Contact a qualified service technician.
HIGH TMP	Oil/shortening has reached an unsafe temperature.	Turn off appliance. Allow time for appliance to cool before turning on.
	Incorrect probe reading.	Contact a qualified service technician.
SYSTEM FAILURE	Temperature probe is shorted.	Contact a qualified service technician.
POLISH NOW	This message indicates that oil in the vat is in need of polishing.	Operators may (depending on settings) polish now, or defer the polish filter operation for a later time.



Annual service to this appliance by an authorized person is recommended. Do not modify this appliance: servicing must only be carried out by an authorized person. For service and parts, minor adjustments, fault finding, or if this appliance cannot be adjusted to operate correctly, contact:

In the event of problems with or questions about your order, please contact the Pitco Frialator factory at:
(603) 225-6684 World Wide
Website Address: www.pitco.com

In the event of problems with or questions about your equipment, please contact the Pitco Frialator Authorized Service and Parts representative (ASAP) covering your area, or contact Pitco at the numbers listed to the left.

MAILING ADDRESS – P.O. BOX 501, CONCORD, NH 03302-0501
SHIPPING ADDRESS – 10 FERRY ST., CONCORD, NH 03301