



Project _____
 AIA # _____ SIS # _____
 Item # _____ Quantity _____ C.S.I. Section 114000



AM16-ASR ELECTRIC

High Temperature Door-Style Dishwashing Machine



SPECIFIER STATEMENT

Specified unit will be Hobart AM16 ASR electric high temperature dishwashing machine. Features include automatic soil removal, 5-sided insulated hood, touchscreen controls with WiFi connectivity, NSF pot and pan rating for 2-, 4- & 6-minute cycles, 17" door opening, pumped drain, auto door start with auto fill, interchangeable stainless steel rinse arms and X-shaped wash arms, auto delime, advanced diagnostics and service connection, up to 52 racks per hour, .67 U.S. gallons per rack pumped final rinse.

1 year parts and labor warranty.

STANDARD FEATURES

- + .67 gallons per rack pumped final rinse
- + 52 racks per hour – hot water sanitizing
- + Automatic soil removal (ASR)
- + Pillarless opening
- + 5-sided insulated hood
- + User-friendly smart touchscreen controls
- + Single point electrical connection standard, field convertible to dual point connection
- + 3 phase standard, field convertible to single phase
- + WiFi connectivity
- + SmartConnect app and cloud with machine status, temperature logs, error code reporting, and cost, consumption and usage analysis
- + Temperature and chemical lock outs (with Hobart equipped chemical pumps)
- + Pumped drain
- + Timed wash cycles for 1, 2, 4 or 6 minutes
- + NSF pot and pan rating for 2-, 4- & 6- minute cycles
- + Sense-A-Temp™ 70°F rise electric booster heater
- + Self-draining, high efficiency wash pump with stainless steel impeller
- + 17" door opening
- + Stainless steel drawn tank, tank shelf, chamber, trim panels, frame and feet
- + Spring counterbalanced chamber with reinforced, thermo-plastic rollers
- + X-shaped revolving, interchangeable upper and lower anticlogging wash arms
- + Revolving, interchangeable upper and lower rinse arms
- + Slanted, self-locating, one-piece scrap screen and basket system
- + Automatic fill
- + Door actuated start
- + AutoClean
- + Drain water tempering kit
- + Factory startup
- + Vent fan control
- + Service diagnostics
- + Straight-through or corner installation
- + Auto delime

OPTIONS & ACCESSORIES (Available at extra cost)

- Peg rack
- Combination rack
- ASR left hand conversion kit
- Chemical pumps
- Splash shield for corner installations
- Flanged and seismic feet
- Water hammer arrestor kit
- Door lock kit
- Rapid fill kit
- Sink integration kit
 - Sink saddle & 3" leg extension
 - Sink rail kit
 - Fold down table

AM16 SERIES – AM16-ASR ELECTRIC

Approved by _____ Date _____ Approved by _____ Date _____



AM16-ASR ELECTRIC

High Temperature
Door-Style Dishwashing Machine

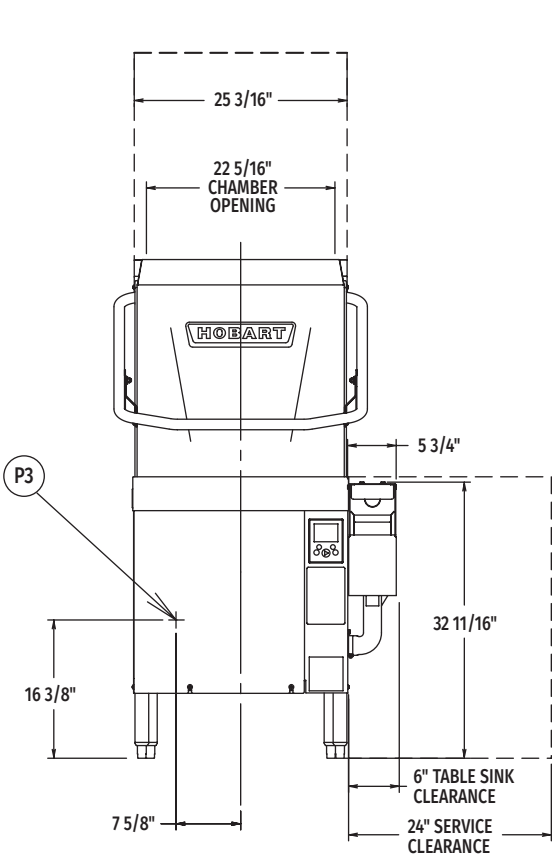

Front View

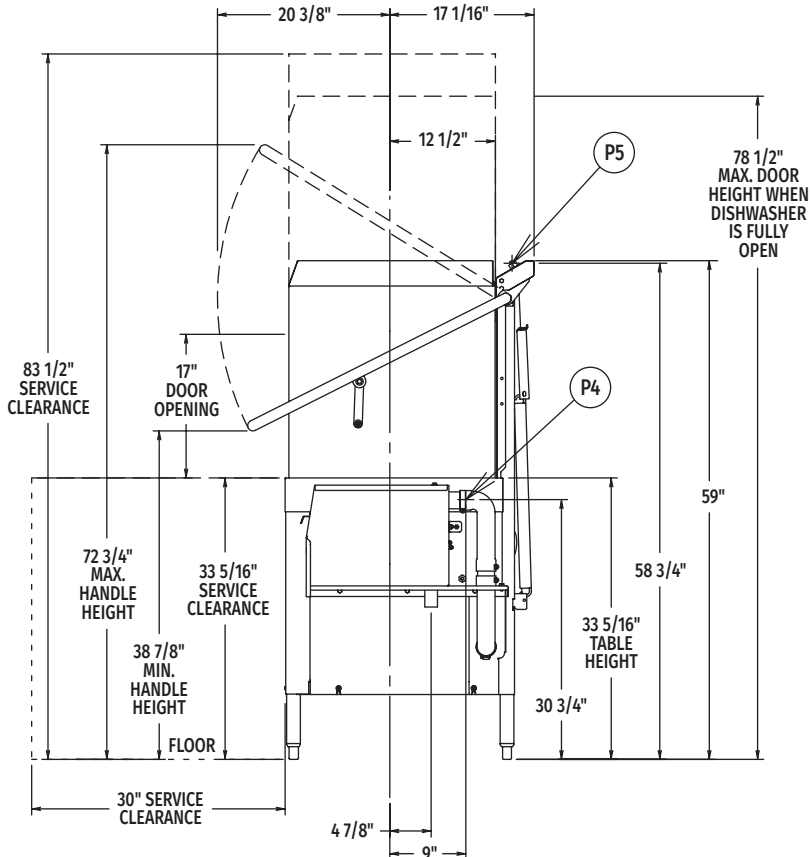

Right Side View

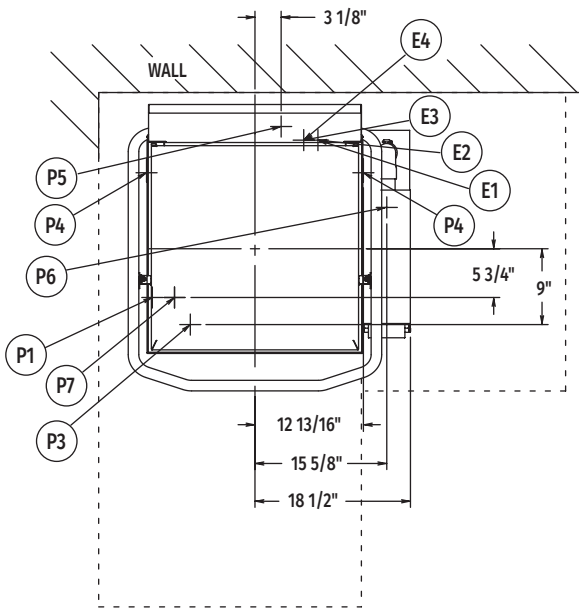

Top View

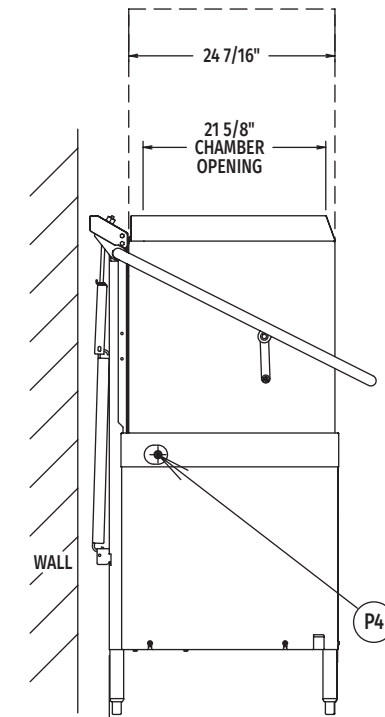

Left Side View

MODEL:
AM16-ASR
E-950440



AM16-ASR ELECTRIC

High Temperature Door-Style Dishwashing Machine

WARNING: Electrical and grounding connections must comply with the applicable portion of the National Electrical Code and/or other local electrical codes.

Plumbing connections must comply with applicable sanitary, safety, and plumbing codes.

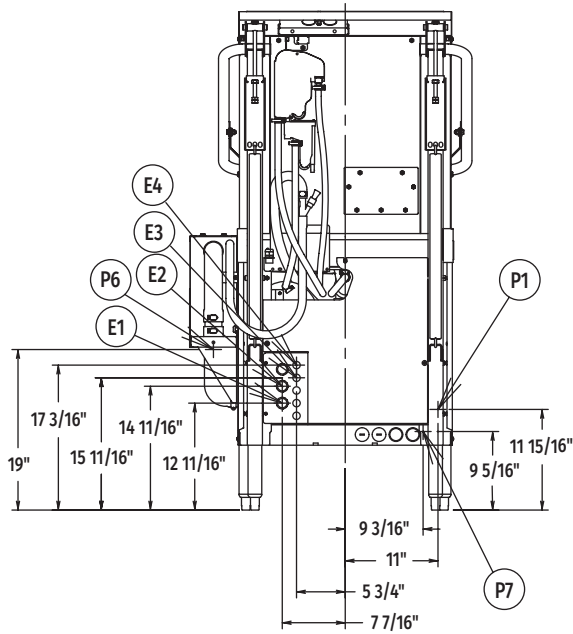

Rear View

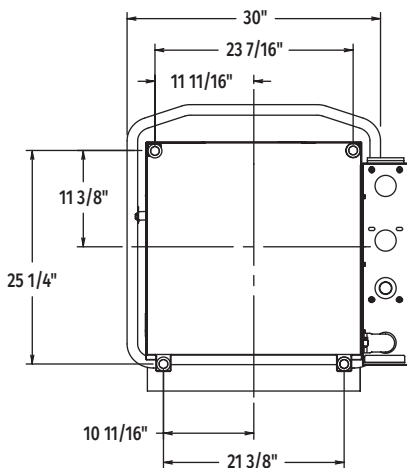

Bottom View

LEGEND

Electrical Connections	
E1	Electrical connection: wash pump motor & sump heater, 1" or 3/4" conduit hole; 12-11/16" AFF.
E2	Electrical connection: electric booster & controls only or single point electrical connection (3PH only) 1" or 3/4" conduit hole; 14-11/16" AFF.
E3	Electrical connection: detergent & rinse agent feeders, (DPS1 & DPS2) 1.5 amps @ nameplate supply voltage. (RPS1 & RPS2) 1.5 amps @ nameplate supply voltage; 1/2" conduit hole, 15-11/16" AFF.
E4	Electrical connection: vent fan control (VFC1 & VFC2) switching circuit only 1.5 amps @ nameplate supply voltage; 1/2" conduit hole, 17-3/16" AFF.
Plumbing Connections	
P1	Common water connection including booster heater: 110°F water minimum, 15-65 PSI recommended; 3/4" female garden hose fitting on 6' long hose supplied with machine; 11-15/16" AFF.
P3	Detergent probe sensor: remove cap and stud assembly to access 7/8" hole; 16-3/8" AFF.
P4	Detergent feeder: two locations available. Remove cap and stud assembly to access 7/8" hole; 30-3/4" AFF.
P5	Rinse agent feeder: remove 1/8" NPT pipe plug to access 1/8" NPT tapped hole; 58-3/4" AFF.
P6	Drain connection: includes machine drain & drain water tempering (LH ASR accessory drain location on opposite side). 1-1/2" stainless steel tube fitting 19" AFF.
P7	Cold water connection: 55°F water minimum (drain water tempering); 3/4" female garden hose fitting on 8' long hose; 9-5/16" AFF.

SPECIFICATIONS

Capacities

Racks Per Hour (maximum)	52
Dishes per Hour (average 25 per rack)	1,300
Glasses per Hour (average 45 per rack)	2,340
Wash Tank (U.S. gallons)	10.5

Motor Horsepower

Rinse Pump	0.18
Wash Pump	2
ASR Pump	0.18
Drain Pump	0.21

Rinse

Gallons per Rack	0.67
Gallons per Hour (maximum consumption)	34.84

Peak Rate of Drain Flow

Gallons per Minute (initial rate with full tank)	18.5
--	------

Heating

Electric Booster (kW)	7.1
Electric Heating Unit (kW)	5.4

Exhaust Requirements 450 CFM

Shipping Weight (approximate) 342 lbs.

Crated Dimensions 65.125"H x 36.5"W x 36.5"L



AM16-ASR ELECTRIC

High Temperature Door-Style Dishwashing Machine

E1 AM16 with Electric Heat (When Field Converted to Dual Point)			
Voltage	Rated Amps	Minimum Supply Circuit Ampacity	Maximum Protective Device
208-240/60/1	39.6	50	50
208-240/60/3	26.9	30	30

E2 9.5 kW Booster & Controls Ampacity Ratings (When Field Converted to Dual Point)			
Voltage	Rated Amps	Minimum Supply Circuit Ampacity	Maximum Protective Device
208-240/60/1	43.3	50	50
208-240/60/3	26.6	30	30

E2 AM16 Single Point Electrical Service Connection as Shown Below			
Voltage	Rated Amps	Minimum Supply Circuit Ampacity	Maximum Protective Device
208-240/60/3	53.48	60	60

Approximate Heat Gain to Space without Vent Hood	
Type	BTU/Hr.
Latent	7,800
Sensible	4,000

Miscellaneous Notes: All dimensions taken from floor line may increase 7/8" or decrease 3/8" depending on leg adjustment. Vent hood (if required) to provide a minimum 450 CFM exhaust (ref installation instructions). Net weight of machine including booster: 325 lbs. Domestic shipping weight including booster: 345 lbs. Size of racks – 19 1/4" x 19 3/4".

Plumbing Notes: Water hammer arrestor (meeting ASSE-1010 standard or equivalent) to be supplied (by others) in common water supply line at service connection. Recommended water hardness to be 3 grains or less for best results. Recommended building flowing water pressure to the dishwasher at or above 20 PSI. Pressures lower than 20 PSI may affect machine fill/start-up times. This is a pumped rinse machine. Pressure regulating valve is not necessary on hot or cold lines. For convenience when cleaning, water tap should be installed near machine with heavy duty hose and squeeze valve.

AM16-ASR TABLING CONFIGURATIONS AND TRACK DESIGN

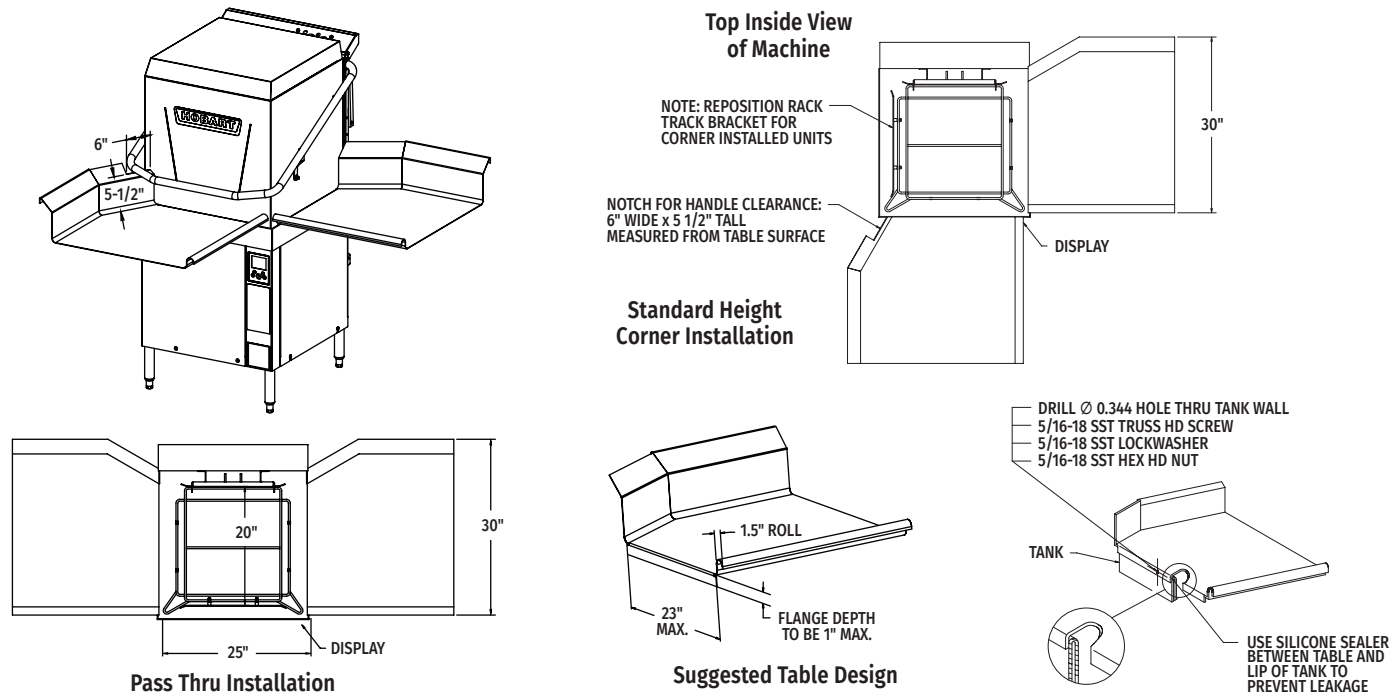

As continued product improvement is a policy of Hobart, specifications are subject to change without notice.