

**HEAVY DUTY COOKING****VULCAN****ARS SERIES  
SELF-CONTAINED REFRIGERATED BASES****Model ARS72**

(Shown with optional right-located compressor with  
ASA griddle, ACB charbroiler and AHP hotplate)



UL listed to U.S. and Canadian safety standards. NSF listed.

**SPECIFICATIONS**

Heliarc welded, fully insulated, stainless steel double pan Cabinet exterior front, sides, louver assembly and drawers are constructed of 20-gauge 430 stainless steel, exterior back and bottom are constructed of heavy gauge galvanized steel. Cabinet interior sides are constructed of 22-gauge 400 series stainless steel, top and bottom are constructed of 22-gauge 300 series stainless steel. A set of 4" high casters are included standard. Vinyl magnetic snap-in drawer gasket assures tight drawer seal. Both the cabinet and drawers are insulated with an average of 2" thick high density, non-CFC, foamed in place polyurethane. The easy to use water resistant INTELA-TRAUL® microprocessor control system is supplied standard. Unit is NAFEM Data Protocol communication (NDP) ready. Optional hardware required to be NDP compliant (3rd party software required for network connection). It includes a 3-Digit LED Display, °F or °C Temperature Scale Display Capability, and an RS485 data port. In addition it includes audio/visual alarms for: Hi/Lo Cabinet Temperature, Clean Condenser, Evaporator Coil and Discharge Line Sensor Failures, and Power Supply Interruption. The left side mounted, self-contained, balanced refrigeration system using R-404A refrigerant features an off-cycle defrost, capillary tube, air-cooled hermetic compressor, automatic condensate evaporator, and a dedicated rear-mounted evaporator design which distributes cold air through

- ARS36** 36" wide
- ARS48** 48" wide
- ARS60** 60" wide
- ARS72** 72" wide
- ARS84** 84" wide
- ARS96** 96" wide
- ARS110** 110" wide

**STANDARD FEATURES**

- Stainless steel top, front, sides and interior
- Marine edge top
- Compressor on left
- 4" casters in adjustable channels
- INTELA-TRAUL microprocessor control system
- Balanced, self-contained refrigeration system that utilizes R-404A
- Front-breathing design allows for zero clearance installation
- Controllable anti-condensate drawer perimeter heaters
- Automatic non-electric condensate filter
- Condenser filter
- Off-cycle evaporator defrost
- Magnetic snap-in drawer gaskets
- Self-closing drawers with stay open feature
- Side, front and rear access panels provide for ease of service and maintenance
- 14-gauge stainless steel drawer slides
- NEMA 5-15 plug with 9' cord and cord retainer
- One year limited parts and labor warranty

**OPTIONS**

- 6" stainless steel legs
- Compressor on right
- 6" cabinet length extension
- Export 220/50/1 voltage
- NAFEM data protocol gateway package

each drawer section. A 9' cord and retainer is provided. Standard operating temperature is 34 to 38°F. Each heavy-duty drawer is designed to accommodate 12" x 20" x 6" deep pans. They are constructed using 14-gauge stainless steel drawer slides and 2" diameter stainless steel rollers. Drawers include both a self-closing and stay-open feature.

**Exterior Dimensions:**

\_\_\_"w x 34"d x 26"h on 4" casters

**VULCAN**

a division of ITW Food Equipment Group LLC

P.O. Box 696 ■ Louisville, KY 40201 ■ Toll-free: 1-800-814-2028 ■ Local: 502-778-2791 ■ Quote & Order Fax: 1-800-444-0602



**ARS SERIES**  
SELF-CONTAINED REFRIGERATED BASES

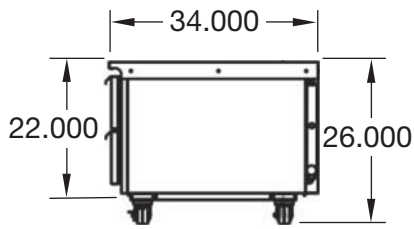

**SIDE VIEW ALL MODELS**

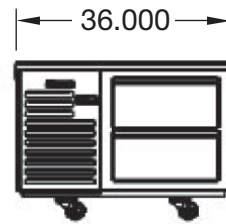
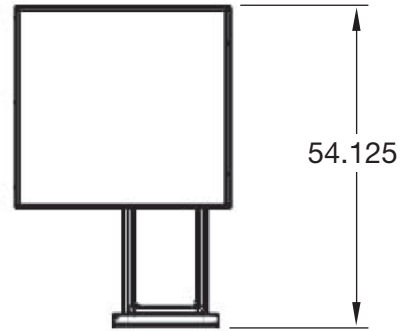

**ARS36**

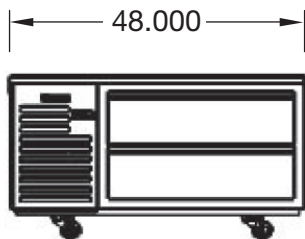
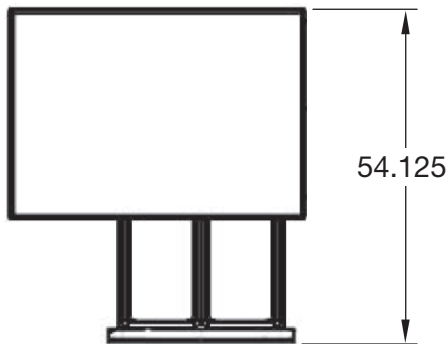

**ARS48**

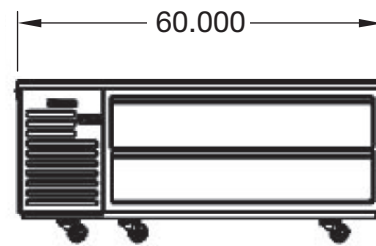
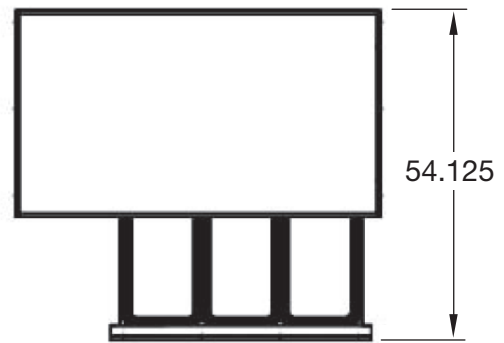

**ARS60**



a division of ITW Food Equipment Group LLC

**HEAVY DUTY COOKING**



**ARS SERIES  
SELF-CONTAINED REFRIGERATED BASES**

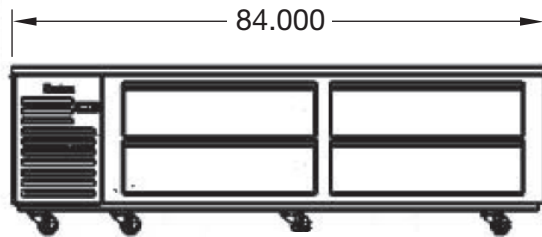
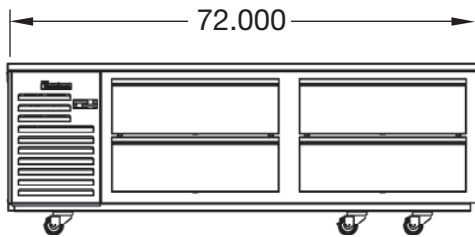
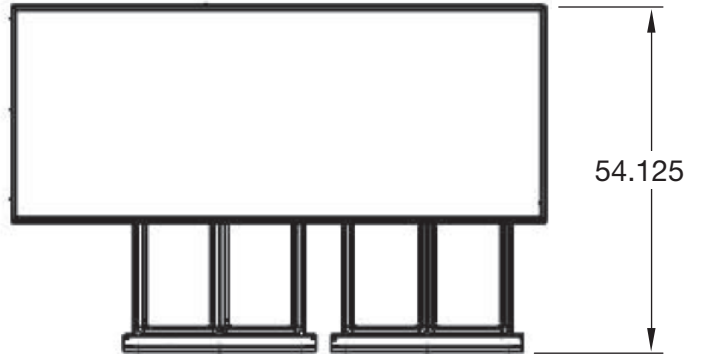
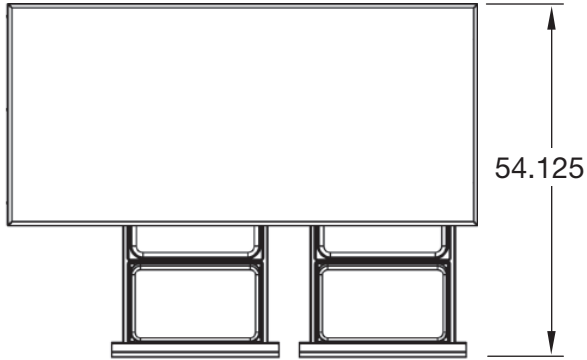

**ARS72**

**ARS84**

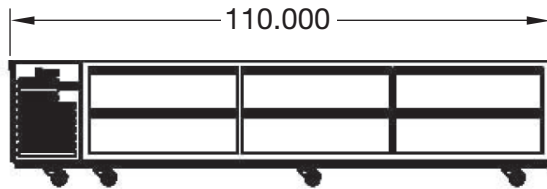
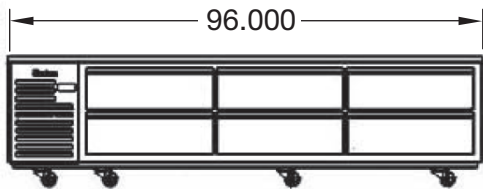
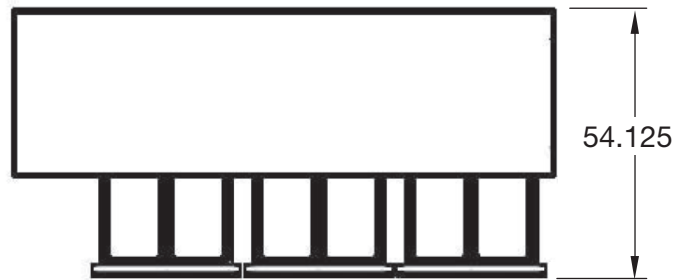
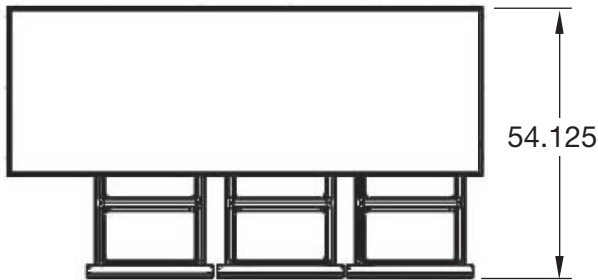

**ARS96**

**ARS110**



a division of ITW Food Equipment Group LLC

P.O. Box 696 ■ Louisville, KY 40201 ■ Toll-free: 1-800-814-2028 ■ Local: 502-778-2791 ■ Quote & Order Fax: 1-800-444-0602



**ARS SERIES**  
SELF-CONTAINED REFRIGERATED BASES

MODEL	BTU/HR-HP <sup>2</sup>	REFRIG.	VOLT/HZ/PH	FULL LOAD AMPS	NEMA PLUG TYPE	MAX. TOP LOAD	PAN ORIENTATION
ARS36	2,440 (1/3 HP)	R-404A	115/60/1	6.7	5-15P	625 lbs.	N/A
ARS48	2,440 (1/3 HP)			6.7		625 lbs.	Side by Side
ARS60	2,440 (1/3 HP)			6.7		625 lbs.	Side by Side
ARS72	2,440 (1/3 HP)			6.7		1,200 lbs.	Front to Back
ARS84	2,440 (1/3 HP)			6.7		1,500 lbs.	Side by Side
ARS96	4,090 (1/2 HP)			12		1,500 lbs.	Front to Back
ARS110	4,090 (1/2 HP)			12		1,500 lbs.	Side by Side

MODEL	COUNTER DEPTH	COUNTER HEIGHT	COUNTER WIDTH	DEPTH W/OPEN DRAWER	NO. OF DRAWERS	PAN CAPACITY 12" x 20" x 6"	APPROX. SHIP WEIGHT	
							LBS	KG
ARS36	34" (914)	26" (660)	36" (914)	54 1/8" (1,375)	2	2	410	186
ARS48			48" (1,219)		2	4	430	195
ARS60			60" (1,524)		2	6	475	216
ARS72			72" (1,829)		4	8	555	252
ARS84			84" (2,134)		4	8	655	297
ARS96			96" (2,438)		6	12	760	345
ARS110			110" (2,794)		6	12	845	383

Dimensions in ( ) are in millimeters



a division of ITW Food Equipment Group LLC

P.O. Box 696 ■ Louisville, KY 40201 ■ Toll-free: 1-800-814-2028 ■ Local: 502-778-2791 ■ Quote & Order Fax: 1-800-444-0602

**NOTE:** In line with its policy to continually improve its products, Vulcan reserves the right to change materials and specifications without notice.