

# SANIWALL™ & SANISTAND™ Touchless Sanitizer Automated Dispenser

## SANIWALL™ Wall Mount



**Product Dimensions**  
H 18" x W 6" x D 4.5"  
**Type:** LIQUID/GEL  
**SKU:** 200-SANIWALL01



*Requires 4x C-size batteries.  
Not included*

### STEP 1

Open it with key, take out the bottle and pump

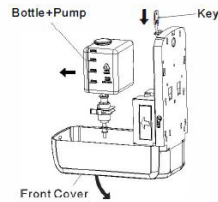

### Install Black Holder

### STEP 2

Install the back holder with dispenser

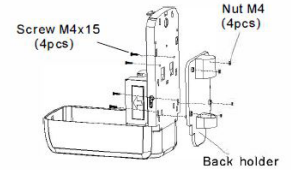

### STEP 3

Put Advertising photo inside of 2 pcs AD board

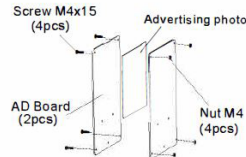

\* Advertising photo size: 18x 18cm

### Install AD Board (If needed)

### STEP 4

Install the AD Board on dispenser

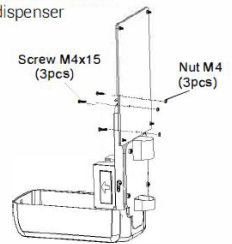

## SANISTAND™ Wall Mount



**Product Dimensions:**  
H 59" x W 6" x D 4.5"  
**Type:** LIQUID/GEL  
**SKU:** 200-SANISTAND01



*Requires 4x C-size batteries.  
Not included*

### STEP 5

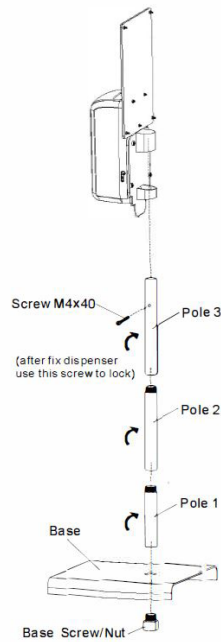

### Install Pole and Base

### STEP 6

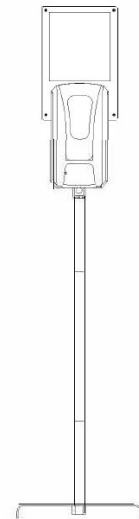

\* fix 4 pcs C size batteries,  
fill liquid and turn on the  
switch.

**MVP GROUP, LLC**

12000 Biscayne Blvd., Suite 108

Miami, Florida 33181

Tel. 786.600.4687 / Fax: 786.661.4100 | Email: sales@mvpgroupcorp.com

### STEP 1

Open it with key, take out the bottle and pump

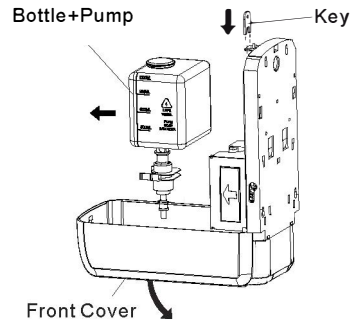

### Install Back Holder

### STEP 2

Install the back holder with dispenser

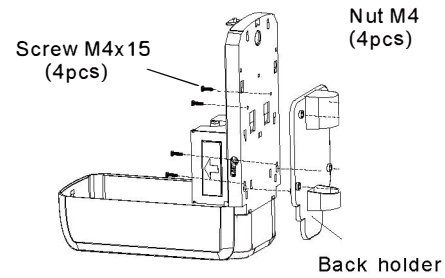

### STEP 5

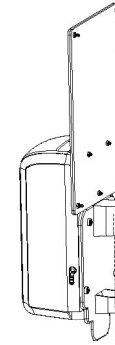

Screw M4x40

(after fix dispenser use this screw to lock)

Pole 3

Pole 2

Pole 1

Base

Base Screw/Nut

### STEP 6

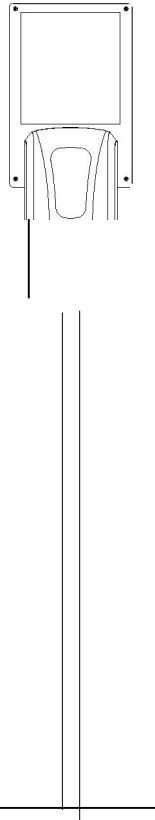

\* fix 4 pcs C size batteries, fill liquid and turn on the switch.

### STEP 3

Put Advertising photo inside of 2 pcs AD board

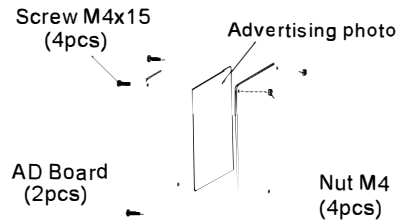

\* Advertising photo size: 18x 18cm

### Install AD Board (If Needed)

### STEP 4

Install the AD Board on dispenser

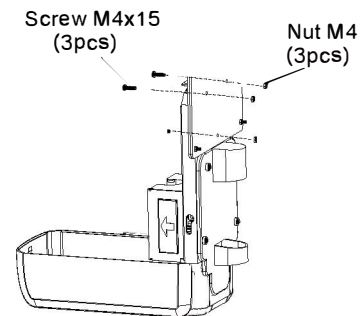

### Install Pole and Base