

RAPIDO Speed Oven

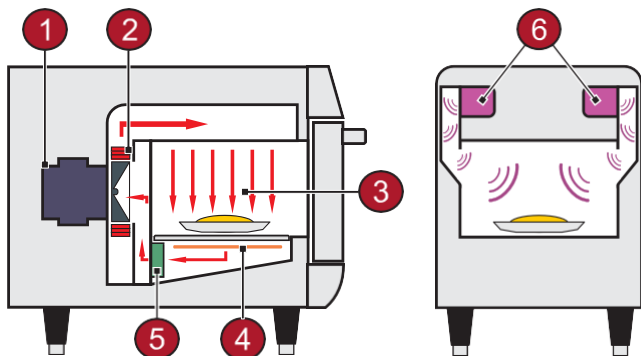

VENTILATION

- ETL Mark listed for ventless certification.
- EPA 202 test
 - Product: Pepperoni Pizza
 - Results: 0.46 mg/m³
 - Ventless Requirements: <5.00 mg/m³
- Easy to remove catalytic converter reduces grease, smoke, and odor emissions.



1. Blower Motor
2. Impingement Heater
3. Impinged Air
4. IR heater
5. Catalytic Converter
6. Magnetrons

PERFORMANCE

- The Rapido speed oven utilizes a combination of convection heat, high speed impinged air, bottom infrared, and precision microwave to reduce cook times by more than 80% with chef-quality results. Rapido speed ovens are equipped with a removable catalytic converter, which break down grease-laden vapors allowing for ventless operation.

FEATURES

- Up to 80 recipes with 6 steps each;
- USB port to upload/download recipes;
- Easy to clean;
- Adjustable temperature from 86°F (30°C) to 536°F (280°C);
- User Friendly Interface;
- Cool to the touch exterior;
- Certified ventless with easy removable catalytic converter;
- Variable-speed impingement airflow;
- Independently controlled top and bottom heaters;
- Ventless side panels allow for zero side clearance installation;
- Allows the use of metal pans;
- Constructed from AISI430 (exterior) and AISI304 (interior) stainless steel;
- Manual mode for on-the-fly cooking;
- Warranty – 1 year parts and labor.

STANDARD ACCESSORIES

- Panini Style Grill Plate;
- Solid PTFE Basket - 14.5" x 11.8"
- Aluminum Paddle
- USB Flash Drive

* Ventless cooking operation supported with the exception of foods classified as 'raw fatty proteins' such as bone-in, skin-on chicken, raw bacon, raw hamburger, etc.

* Ultimate ventless allowance is dependent upon AHJ approval, as some jurisdictions may not recognize the ETL certification or application.



AXIS is a registered trade mark of MVP Group. Specifications subject to change without notice.



PRODUCT DIMENSIONS

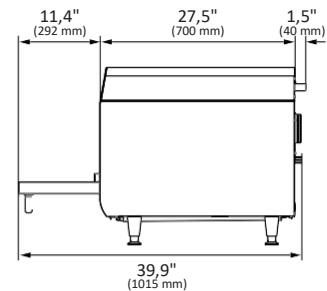
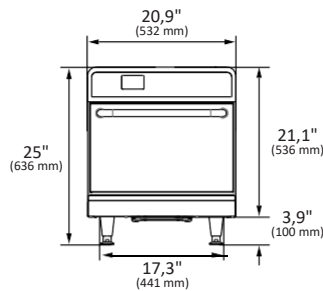
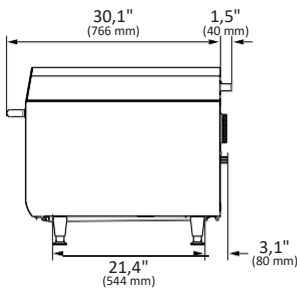

INSTALLATION

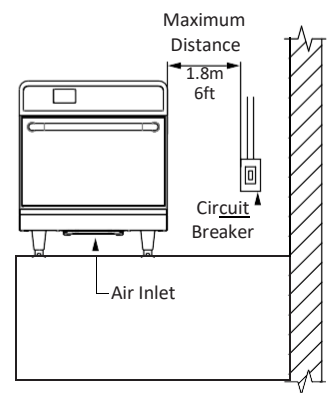
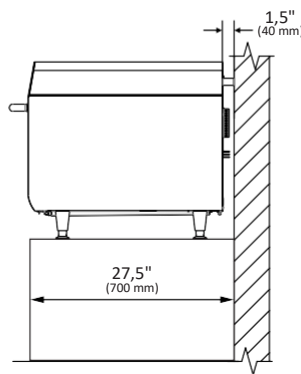
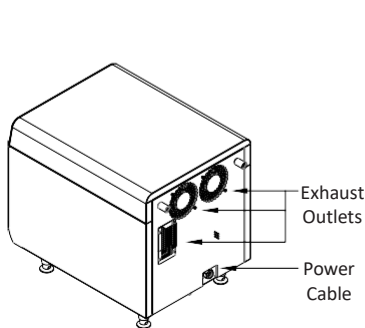

ELECTRICAL SPECIFICATIONS

Ensure that the electrical characteristics of the building network are in accordance with the technical specifications located on the data badge located on rear panel of the unit. The outlet should be located no more than 6ft / 1.8m away from the unit.

This unit must be properly grounded to avoid electrical shock. This unit is equipped with a 3-prong plug.

This plug must be connected to a properly installed and grounded outlet. In the event of an electrical short, properly grounding the unit reduces the risk of electrical shock by grounding the electrical current.

The building electrical is the customer's responsibility.

Region	Voltage (V)	Phases	Freq. (Hz)	Power (kW)	Circuit Breaker (A)	Cable	Socket
USA	208	Single	60	6.2	30	3x10AWG	NEMA 6-30
	240			7.2			
Canada	208	Single	60	6.2	30	3x10AWG	NEMA 6-30
	240			7.2			

GENERAL INSTRUCTIONS

The oven must be installed on a base or counter that supports the weight of the unit (approximately 194 lbs. / 88 kg)

For proper ventilation, a minimum space of 1,5" (40mm) between the rear of the oven and the wall is required.

Do not block the air inlets and exhaust outlets located on the bottom and rear of the oven.

It is not recommended for the unit to be positioned near stoves, deep fryers, hot plates and other equipment that releases fat, fumes and heat.

The oven must be installed at a leveled and ventilated location.

Improper installation may void the equipment warranty.

DIMENSIONS

Rapido	Product Dimensions				Boxed Product Dimensions			
	Height	Width	Depth	Weight	Height	Width	Depth	Weight
	25" 636mm	20,9" 532mm	31,7" 806mm	194lbs 88kg	31,4" 800mm	22" 560mm	33,8" 860mm	242lb 110kg
Chamber Dimensions	Capacity		Height		Width		Depth	
	0.74 cu.ft 21L	5,7" 146mm	0.4 ft	15,5" 394mm	1.2 ft	14,2" 362mm	1.1 ft	1.1 ft
Wall Clearance	Left Side		Back		Right Side			
	0" 0mm	0 ft	0" 0mm	0 ft	0" 0mm	0 ft	0" 0mm	0 ft



AXIS is a registered trade mark of MVP Group. Specifications subject to change without notice.