



TRUE FOOD SERVICE EQUIPMENT, INC.

2001 East Terra Lane • O'Fallon, Missouri 63366-4434 • (636)240-2400
 Fax (636)272-2408 • Toll Free (800)325-6152 • Intl Fax# (001)636-272-7546
 Parts Dept. (800)424-TRUE • Parts Dept. Fax# (636)272-9471 • www.truemfg.com

Project Name: _____

Location: _____

Item #: _____ Qty: _____

Model #: _____

A/A #

S/S #

Model:
TUC-27-HC

Undercounter:

Solid Door Refrigerator with Hydrocarbon Refrigerant



TUC-27-HC

- ▶ True's undercounter units are designed with enduring quality that protects your long term investment.
- ▶ Designed using the highest quality materials and components to provide the user with colder product temperatures, lower utility costs, exceptional food safety and the best value in today's food service marketplace.
- ▶ Factory engineered, self-contained, capillary tube system using environmentally friendly R290 hydro carbon refrigerant that has zero (0) ozone depletion potential (ODP), & three (3) global warming potential (GWP).
- ▶ Energy Efficient, environmentally friendly forced-air refrigeration system holds 33°F to 38°F (.5°C to 3.3°C).
- ▶ All stainless steel front, top and ends. Matching aluminum finished back.
- ▶ Interior - attractive, NSF approved, clear coated aluminum liner. Stainless steel floor with coved corners.
- ▶ Front breathing.
- ▶ Heavy duty PVC coated wire shelves.
- ▶ Foamed-in-place using Ecomate. A high density, polyurethane insulation that has zero ozone depletion potential (ODP) and zero global warming potential (GWP).

ROUGH-IN DATA

Specifications subject to change without notice. Chart dimensions rounded up to the nearest 1/8" (millimeters rounded up to next whole number).

Model	Doors	Shelves	Cabinet Dimensions (inches) (mm)			HP	Voltage	Amps	NEMA Config.	Cord Length (total ft.) (total m)	Crated Weight (lbs.) (kg)
			L	D†	H*						
TUC-27-HC	1	2	27 5/8 702	30 1/8 766	29 3/4 756	1/6 1/4	115/60/1 230-240/50/1	2.0 1.8	5-15P ▲	7 2.13	195 89

† Depth does not include 1" (26 mm) for rear bumpers.

* Height does not include 6 1/4" (159 mm) for castors or 6" (153 mm) for optional legs.

▲ Plug type varies by country.

6/16 Printed in U.S.A.

APPROVALS:

AVAILABLE AT:

Model:
TUC-27-HC

Undercounter:
Solid Door Refrigerator with Hydrocarbon Refrigerant



STANDARD FEATURES

DESIGN

- True's commitment to using the highest quality materials and oversized refrigeration systems provides the user with colder product temperatures, lower utility costs, exceptional food safety and the best value in today's food service marketplace.

REFRIGERATION SYSTEM

- Factory engineered, self-contained, capillary tube system using environmentally friendly R290 hydro carbon refrigerant that has zero (0) ozone depletion potential (ODP), & three (3) global warming potential (GWP).
- Energy efficient, factory balanced refrigeration system with guided airflow to provide uniform product temperatures.
- High capacity, factory balanced refrigeration system that maintains cabinet temperatures of 33°F to 38°F (.5°C to 3.3°C) for the best in food preservation.
- State of the art, electronically commutated evaporator and condenser fan motors. ECM motors operate at higher peak efficiencies and move a more consistent volume of air which produces less heat, reduces energy consumption and provides greater motor reliability.
- Condensing unit access in back of cabinet, slides out for easy maintenance.

CABINET CONSTRUCTION

- Exterior - stainless steel front, top and ends. Matching aluminum finished back.
- Interior - attractive, NSF approved, clear coated aluminum liner. Stainless steel floor with coved corners.

- Insulation - entire cabinet structure and solid door are foamed-in-place using a high density, polyurethane insulation that has zero ozone depletion potential (ODP) and zero global warming potential (GWP).
- 5" (127 mm) diameter stem castors - locks provided on front set. 36" (915 mm) work surface height.

DOOR

- Stainless steel exterior with clear aluminum liner to match cabinet interior.
- Door fitted with 12" (305 mm) long recessed handle that is foamed-in-place with a sheet metal interlock to ensure permanent attachment.
- Positive seal self-closing door with 90° stay open feature. Door swing within cabinet dimensions.
- Magnetic door gasket of one piece construction, removable without tools for ease of cleaning.

SHELVING

- Two (2) adjustable, heavy duty PVC coated wire shelves 23 1/4" L x 16" D (591 mm x 407 mm). Four (4) chrome plated shelf clips included per shelf.
- Shelf support pilasters made of same material as cabinet interior; shelves are adjustable on 1/2" (13 mm) increments.

MODEL FEATURES

- Evaporator is epoxy coated to eliminate the potential of corrosion.
- NSF-7 compliant for open food product.

ELECTRICAL

- Unit completely pre-wired at factory and ready for final connection to a 115/60/1 phase, 15 amp dedicated outlet. Cord and plug set included.



OPTIONAL FEATURES/ACCESSORIES

Upcharge and lead times may apply.

- 230 - 240V / 50 Hz.
- 6" (153 mm) standard legs.
- 6" (153 mm) seismic/flanged legs.
- 2 1/2" (64 mm) diameter castors.
- Barrel lock (factory installed).
- Single overshelf.
- Double overshelf.
- TUC-27 Stacking collar.
- 30" (762 mm) deep, 1/2" (13 mm) thick, white polyethylene cutting board. Requires "L" brackets.
- 30" (762 mm) deep, 1/2" (13 mm) thick, composite cutting board. Requires "L" brackets.
- Heavy duty, 16 gauge tops.
- Exterior rectangular digital temperature display (factory installed).
- ADA compliant models with 34" (864 mm) work surface height.

PLAN VIEW

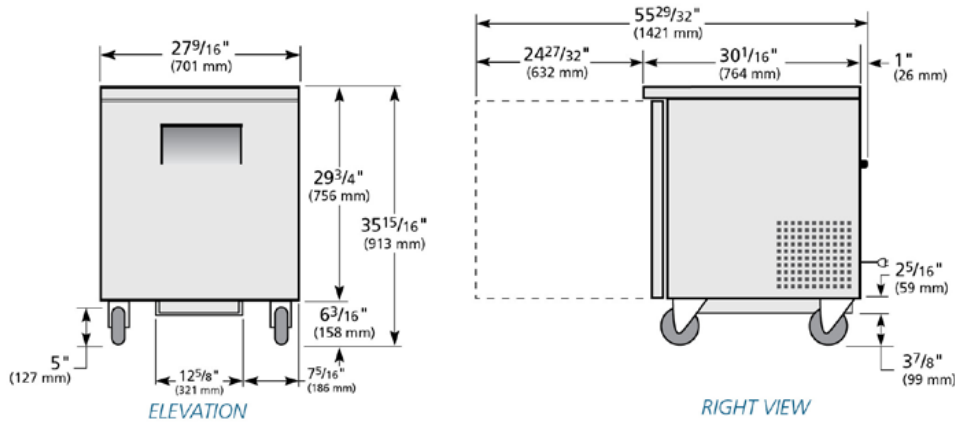

WARRANTY*
Three year warranty on all parts and labor and an additional 2 year warranty on compressor. (U.S.A. only)

METRIC DIMENSIONS ROUNDED UP TO THE NEAREST WHOLE MILLIMETER
SPECIFICATIONS SUBJECT TO CHANGE WITHOUT NOTICE



Model	Elevation	Right	Plan	3D	Back
TUC-27-HC	TFQY01E	TFQY01S	TFQY01P	TFQY013	

*RESIDENTIAL APPLICATIONS: True assumes no liability for parts or labor coverage for component failure, factory defect or any other damages for units installed in non-commercial foodservice or residential applications.

TRUE FOOD SERVICE EQUIPMENT