

**REFRIGERATOR MANUFACTURER**  
**Turbo air**  
 more durable, efficient, beautiful

4184 E. Conant St.  
 Long Beach, CA 90808  
 Tel. 310-900-1000  
 Fax. 310-900-1077  
[www.turboairinc.com](http://www.turboairinc.com)

Project :	
Model # :	
Item # :	Qty :
Available W/H :	
Approval :	

## Worktop Refrigerator

Worktops  
 Super Deluxe Series

**3 YEAR PARTS & LABOR WARRANTY**

**Model : TWR-60SD**



### ≡ FEATURES & BENEFITS ≡

■ **Stainless steel cabinet construction**

The Turbo Air Super Deluxe model boasts a stainless steel interior and exterior (galvanized steel back & bottom). It guarantees the utmost in cleanliness and long product life. The Super Deluxe can add a touch of style to the most refined setting.

■ **Sturdy, clean stainless steel shelving**

Shelves are the most important part of cleanliness as they come in direct contact with food. After a while, PVC coated wire shelves may peel, rust and lead to unsanitary conditions. Only the Turbo Air Super Deluxe series uniquely provides stainless steel shelving.

■ **Efficient refrigeration system**

Turbo Air's solid door refrigerators are designed with oversized and balanced (CFC Free R-134A) refrigeration systems. These include efficient evaporators and condensers for faster cooling and greater efficiency.

■ **High-density polyurethane insulation**

The entire cabinet structure and solid doors are foamed-in-place using high density, CFC free polyurethane insulation.

■ **Ergonomically designed doors**

Customers' fatigue fades away with easy grip handles and doors that open effortlessly. These features along with self-closing doors make this the ultimate choice in customer convenience. ABS sheet door liners resist water condensation with thermal efficiency.

■ **Magnetic door gaskets**

Magnetic door gaskets are of one piece construction, removable without tools for ease of cleaning and replacement.

■ **Refrigerator holds 33°F ~ 38°F for the best in food preservation**



Model	Swing Door	CU./FT.	#of Shelves	HP	AMPS	Crated Weight (lbs.)	L x D* x H† (inches)
TWR-60SD	2	16	2	1/3	8.9	293	60 1/4 x 30 x 33 1/2

## Model : TWR-60SD

ELECTRICAL DATA	
Voltage	115/60/1
Plug Type	Ⓜ NEMA 5-15P
Full Load Amperes	8.9
Compressor HP	1/3
Cord Length ft.	9
Refrigerant	R-134A
DIMENSIONAL DATA	
Net Capacity cu. ft.	16
Ext. Length Overall in.	60 1/4 (1530mm)
Ext. Depth Overall in.*	30 (762mm)
Ext. Height Overall in.†	33 1/2 (851mm)
# of Doors	2
# of Shelves	2
Net Weight lbs.	254
Gross Weight lbs.	293

Design and specifications subject to change without notice.

Actual shipping weight may differ due to extra packing materials for product protection.

\* Depth does not include 1" for rear spacers.

† Height does not include 5-7/8" for caster height.

■ **WARRANTY : 3 Year Parts and Labor Warranty**  
Additional 2 Year Warranty on Compressor

- Self-contained system
- Standard 4" swivel casters with locks on the front set
- 2.5" dia. casters available - 1/2" diameter & 13 TPI (optional)
- Legs available for all models (optional)
- Door locks available (optional)
- External digital thermometer available (optional)

■ **OPTIONAL ACCESSORIES :**

- 2.5" Diameter casters
- 5" Diameter casters
- 6" ABS plastic legs
- Additional stainless steel shelves
- Additional PE coated wire shelves

## PLAN VIEW

(unit : inch)

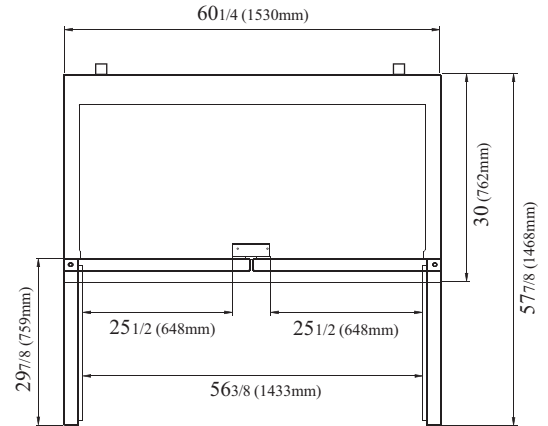

PLAN VIEW

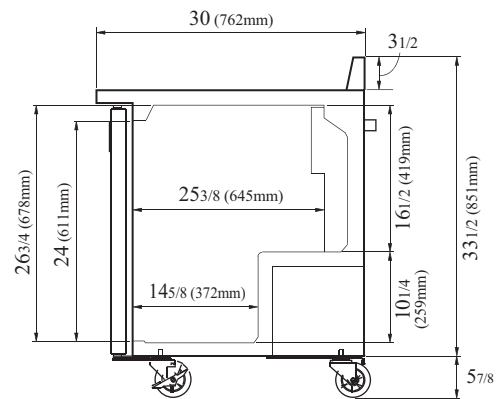

SIDE VIEW

Ver.201501



- Turbo Air : 800-627-0032
- GK : 800-500-3519
- Warranty : 800-381-7770
- AC : 888-900-1002