

CLBC7
Reach-In Blast Chiller
Self-Contained



Reach-In Blast Chiller

STANDARD PRODUCT FEATURES

- High Performance Refrigeration System
- Quickly Chills Hot Food Product Directly from the Oven to under 41°F
- Stainless Steel Front, Sides, Door & Interior
- Easy-to-Use Digital Control for Accuracy
- Adjustable Product Target Temps (40° to 32°F) or Cycle Times
- Two Chill Modes: Hard Chill & Soft Chill
- One (1) Food Probe
- Seven (7) Epoxy Coated Wire Shelves
- Thermostatic Expansion Valve Metering Device
- Field Reversible Door
- Set of Four (4) 4" High Casters with Locks Standard on Front Casters
- High-Density, Non-CFC Foamed in Place Polyurethane Insulation
- Easily Accessible Condenser Coil for Maintenance
- Environmentally Friendly Non-Flammable Refrigerant
- 3 Year Parts & Labor Warranty, Additional 2 Years on Compressor Parts



This unit is listed to the applicable UL, CSA and NSF Standards by an approved NRTL. Consult the factory or unit's data plate for approval information.

ACCESSORIES & OPTIONS (Available at Extra Cost)

- + Set of Four (4) 6" High Casters with Locks Standard on Front Casters
- + Set of Four (4) 6" High Legs

AVAILABLE CONFIGURATIONS

MODELS	HINGING
CLBC7-L	Full Solid Door, Left
CLBC7-R	Full Solid Door, Right

Model	Doors	Shelves	Dimensions L x D x H (in.)	Voltage	Amps	NEMA Plug	Ship Wt. (lbs.)	Net Capacity Cu. Ft.
CLBC7	1	7	34.75 x 38.13 x 61.56*	208-230/60/1	11	6 - 20P	524	11.39

*Note: 61.56 in. height with 4 in. casters

As continued product improvement is a policy of Traulsen, specifications are subject to change without notice.

Approved by _____ Date _____ Approved by _____ Date _____

MODEL - CLBC7

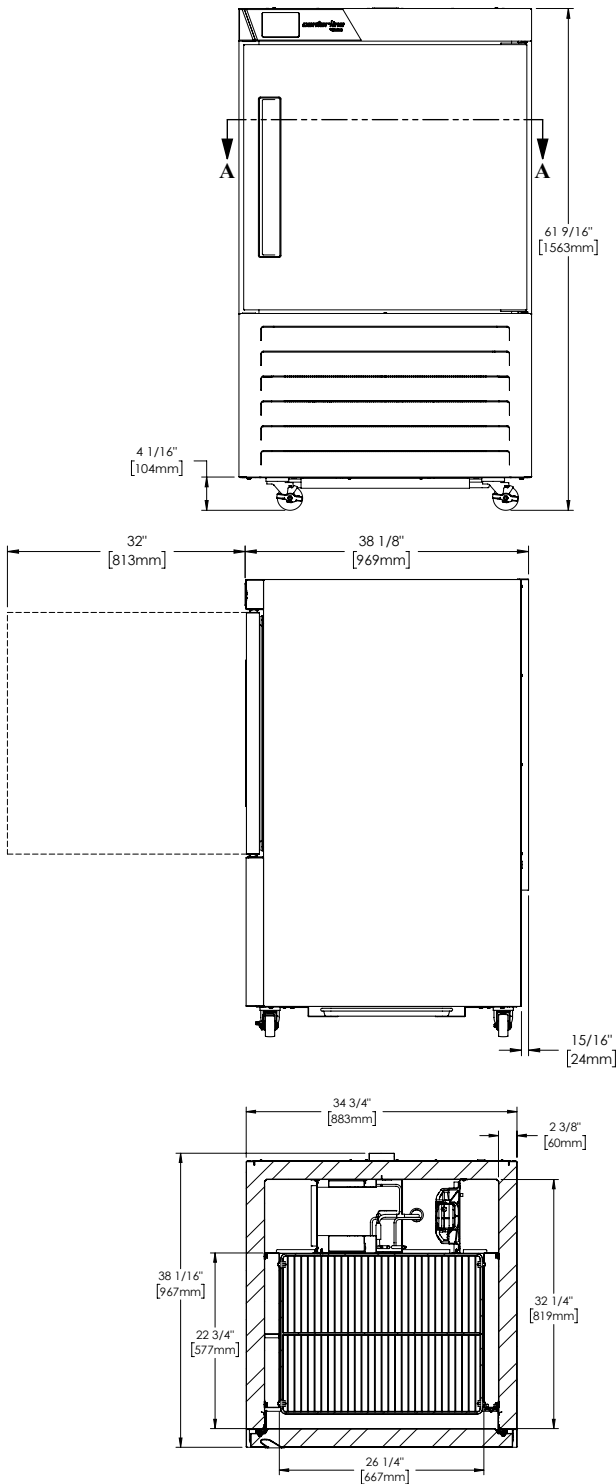

ESTIMATED PERFORMANCE CHART

CLBC7 Product Load	Chill Time From 160°F to 40°F
56 lbs.	90 min.
84 lbs.	120 min.

SPECIFICATIONS

CONSTRUCTION, HARDWARE, INSULATION

Cabinet front, sides, door, and interior are constructed of heavy gauge stainless steel. The exterior cabinet top, back and bottom are constructed of heavy gauge galvanized steel. Door is equipped with a stay open feature at 120 degrees. Anti condensate heaters are located behind the door opening. Both the cabinet and door are insulated with an average of 2" thick high density, non-CFC, 100% foamed in place polyurethane.

REFRIGERATION SYSTEM

High-capacity, self-contained refrigeration system using environmentally friendly, non-flammable R-448A refrigerant is coupled with an advanced air circulation system to rapidly chill hot food through the HACCP danger zone. The condenser coil is front facing for easy cleaning. Defrost occurs automatically.

CONTROLLER

The easy to use 2.8 inch digital display is water resistant and has five (5) capacitive keys. Using the probe provided, it monitors cycle progress.

INTERIOR

Standard interior arrangements include seven (7) epoxy coated wire shelves, mounted on clips and pilasters.

WARRANTY

Both a 3 Year Parts & Labor Warranty and additional 2 Years on Compressor Parts Warranty are supplied standard.

MODELS	CLBC7
DIMENSIONAL DATA	
Pan Capacity	(7) 18" x 26" (14) 12" x 20"
ELECTRICAL DATA	
Voltage	208-230/60/1
Feed Wires with Ground	3
Full Load Amperes	11
REFRIGERATION DATA	
Refrigerant	R-448A
Refrigerant Charge oz.	30 oz (850.5 g)
BTU/HR ¹ H.P.	6020 1-1/2
SHIPPING DATA	
Depth Crated in.	40 (101.6 cm)
Height Crated in.	85 (215.9 cm)
Length Crated in.	37 (93.98 cm)
Volume Crated cu. ft.	73 (2067.1 l)
Net Weight lbs.	445 (202 kg)
Gross Weight lbs.	524 (238 kg)

NOTES:

1. BTU/HR based on a 100°F ambient and 0°F evaporator

Equipped with one NEMA 6-20P Plug



CAD and/or Revit Files Available