



SlimJim®

A variety of lid options for Slim Jim® containers encourages waste separation and recycling with interchangeable, color-coded tops.

Features and Benefits:

SLIM JIM® LIDS

- **Swing Lid** conceals waste from view and provides no-touch access
- **Hinged Lid** folds flat while in use and completely covers waste when closed; complies with Health and Human Services Standard 5-501.11.3 of the 2005 FDA Food Code
- **Bottles and Cans Lid/Paper Lid/Mixed Recycling Lid** encourages waste separation and recycling with interchangeable color-coded tops

Material Composition:

Injection-grade resin material

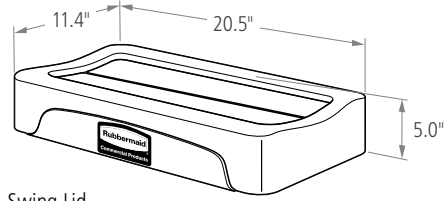

Swing Lid

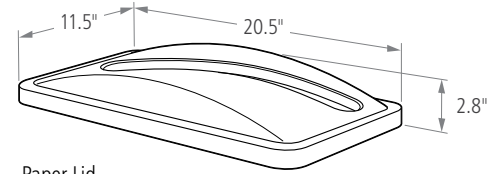

Paper Lid

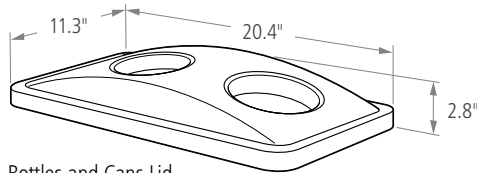

Bottles and Cans Lid

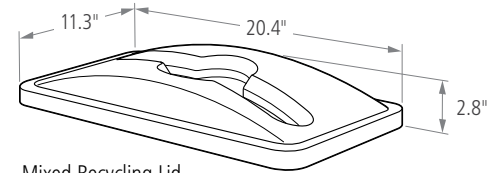

Mixed Recycling Lid

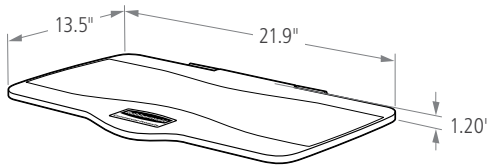

Hinged Lid (Closed Lid)

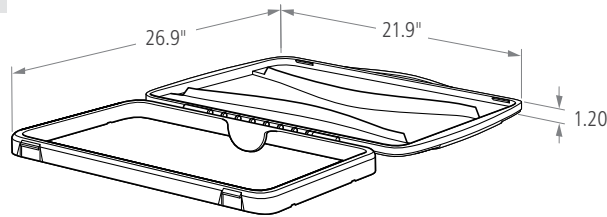

Hinged Lid (Open Lid)

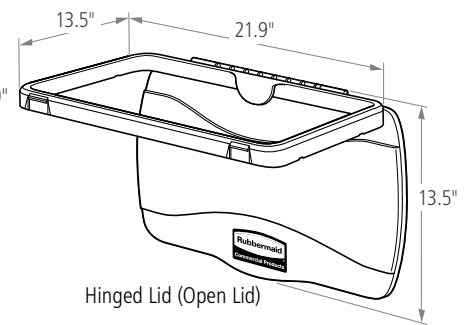

Hinged Lid (Open Lid)

SKU #	DESCRIPTION	COLOR	LENGTH		WIDTH		HEIGHT		PACK SIZE
			IN	CM	IN	CM	IN	CM	
FG267360BEIG	SWING LID	BEIGE	20.50"	52.07	11.40"	28.95	5"	12.70	4
FG267360BLA	SWING LID	BLACK	20.50"	52.07	11.40"	28.95	5"	12.70	4
FG267360BLU	SWING LID	BLUE	20.50"	52.07	11.40"	28.95	5"	12.70	4
FG267360GRY	SWING LID	GRAY	20.50"	52.07	11.40"	28.95	5"	12.70	4
1829400	SWING LID	GREEN	20.50"	52.07	11.40"	28.95	5"	12.70	4
FG269288BLU	BOTTLES AND CANS LID	BLUE	20.40"	51.82	11.30"	28.70	2.80"	7.11	4
FG269288BRN	BOTTLES AND CANS LID	BROWN	20.40"	51.82	11.30"	28.70	2.80"	7.11	4
FG269288GRN	BOTTLES AND CANS LID	GREEN	20.40"	51.82	11.30"	28.70	2.80"	7.11	4
FG269288RED	BOTTLES AND CANS LID	RED	20.40"	51.82	11.30"	28.70	2.80"	7.11	4
FG269288YEL	BOTTLES AND CANS LID	YELLOW	20.40"	51.82	11.30"	28.70	2.80"	7.11	4
FG270388BLU	PAPER LID	BLUE	20.50"	52.07	11.50"	29.21	2.80"	7.11	4
FG270388GRN	PAPER LID	GREEN	20.50"	52.07	11.50"	29.21	2.80"	7.11	4
1788372	MIXED RECYCLING LID	BLUE	20.40"	51.82	11.30"	28.70	2.80"	7.11	4
FG267400BLA	HINGED LID	BLACK	21.90"	55.63	13.50"	34.29	1.20"	3.05	4

LIDS FOR SLIM JIM® CONTAINERS

162709 | 123456

©2016 Rubbermaid Commercial Products LLC
8900 Northpointe Executive Park Drive, Huntersville, NC 28078

