



Merrychef **eikon**[®] **e1s** high speed oven

US/CA

Microwave combination oven
Operations and installation guide – USA/Canada

Part number: 32Z3981





Read instructions before use

Expanding your opportunities™



www.merrychef.com

Safety symbols used in this document or on appliance

Symbols on appliance

Area	Symbol	Descriptions
1		Microwaves warning There is a risk of external and internal burns of body parts following exposure to microwave energy.
2		Electric shock warning There is a risk of electric shock if the appliance is serviced without disconnecting the electrical supply.
3		Fire / electric shock warning There is a risk of fire / electric shock if the appliance is operated without respecting the minimum clearances.
4		Hot surface warning There is a risk of burns from high temperatures inside the cavity and on the inside of the appliance door.
5		Electric shock warning There is a risk of electric shock if the electrical power is not connected to a properly grounded outlet.
6		Equipotential bonding

Symbols in document

Symbol	Meaning
	Warnings of potential injuries. Heed all the warning notices that appear after this symbol to avoid potential injuries or death.
	See Operations Guide or section specified.



Warning notices

Hazard level	Consequences	Likelihood
	Death / serious injury (irreversible)	Immediate risk
	Death / serious injury (irreversible)	Potential risk
	Minor injury (reversible)	Potential risk
	Damage to property	Potential risk





Symboles de sécurité utilisés dans ce document ou sur appareil





Symboles sur l'appareil

Zone	Symbole	Descriptions
1		Alerte micro-ondes Risque de brûlures externes et internes de parties du corps suite à exposition à l'énergie du micro-ondes.
2		Avertissement choc électrique Risque de choc électrique si l'appareil est entretenu sans débrancher l'alimentation électrique.
3		Avertissement incendie / choc électrique Risque d'incendie / de choc électrique si l'appareil est actionné sans respecter les espaces libres minimaux.
4		Avertissement de surface chaude Risque de brûlures par les hautes températures siégeant dans l'enceinte de cuisson et à l'intérieur de la porte de l'appareil.
5		Avertissement choc électrique Risque de choc électrique si l'alimentation électrique n'est pas raccordée sur une prise correctement mise à la terre.
6		Liaison équipotentielle

Symboles dans le document

Symbole	Signification
	Avertissement sur des blessures potentielles. Respecter tous les avertissements apparaissant après ce symbole pour éviter les blessures potentielles voire la mort.
	Voir le Guide d'utilisation ou la section spécifiée.

Notifications d'avertissement

Niveau de risque	Conséquences	Probabilité
 DANGER	Mort / blessure grave (irréversible)	Risque immédiat
 AVERTISSEMENT	Mort / blessure grave (irréversible)	Risque potentiel
 PRUDENCE	Blessure mineure (réversible)	Risque potentiel
 DOMMAGE	Domage matériel	Risque potentiel



FOR THE INSTALLER, OPERATOR, RESPONSIBLE OWNER

	WARNING
	Improper installation, adjustment, alteration, service or maintenance can cause property damage, injury and death. Read the installation, operating and maintenance instructions thoroughly before installing or servicing this equipment.

	WARNING
	<p>PRECAUTIONS TO AVOID POSSIBLE EXPOSURE TO EXCESSIVE MICROWAVE ENERGY</p> <ul style="list-style-type: none"> ▷ Do not attempt to operate this oven with the door open since open-door operation can result in harmful exposure to microwave energy. It is important not to defeat or tamper with the safety interlocks. ▷ Do not place any object between the oven front face and the appliance door or allow soil or cleaner residue to accumulate on sealing surfaces. ▷ Do not operate the oven if it is damaged. It is particularly important that the oven door closes properly and that there is no damage to the (1) door (bent), (2) hinges and latches (broken or loosened), (3) door seals and sealing surfaces. ▷ The oven should not be adjusted or repaired by anyone except properly qualified service personnel.

	WARNING
	Disconnect power at the main external power switch before servicing or repairing a microwave combination oven.

	WARNING
	<p>To reduce the risk of electric shock, do not remove or open cover.</p> <p>No user serviceable parts inside. Refer servicing to qualified personnel. Disconnect power supply before servicing.</p>

IMPORTANT

Customer documentation

- The customer documentation is part of the microwave combination oven.
- Keep the customer documentation manuals handy at all times so that you can look up any required information.
- Keep the customer documentation manuals for the entire life of the appliance.
- Carefully read the installation and operating manual before using, handling, and working on this appliance.
- If you transfer the microwave combination oven to a new owner, make sure to give the new owner the customer documentation manuals as well.



À L'ATTENTION DE L'INSTALLATEUR, DE L'OPÉRATEUR, DU PROPRIÉTAIRE RESPONSABLE

	AVERTISSEMENT
	L'installation, le réglage, la modification, la réparation ou l'entretien incorrect de cet appareil peut causer des dommages matériels, des blessures ou la mort. Lire attentivement les instructions d'installation, de fonctionnement et d'entretien avant de procéder à son installation ou entretien.

	AVERTISSEMENT
	PRÉCAUTIONS POUR ÉVITER L'EXPOSITION EXCESSIVE POSSIBLE À L'ÉNERGIE MICRO-ONDES <ul style="list-style-type: none">▷ Ne pas tenter d'opérer ce four lorsque la porte est ouverte puisque le fonctionnement avec la porte ouverte peut résulter en une exposition dangereuse à l'énergie micro-ondes. Il est important de ne pas trafiquer les dispositifs du verrouillage sécuritaire.▷ Ne jamais placer d'objet entre l'avant du four et la porte ou permettre aux saletés ou aux résidus du nettoyeur de s'accumuler sur les surfaces d'étanchéité.▷ Ne pas utiliser le four si celui-ci est endommagé. Il est particulièrement important que la porte se ferme correctement et qu'il n'existe aucun signe de dommage sur (1) la porte (pliée), (2) les charnières et les verrous (cassés ou desserrés), (3) les joints de la portes et les surfaces d'étanchéité.▷ Le four ne devrait pas être ajusté ou réparé par personne d'autre que le personnel de service qualifié.

	AVERTISSEMENT
	Avant toute intervention de maintenance ou de réparation sur un four mixte, débrancher l'alimentation électrique à l'aide de l'interrupteur général externe.

	AVERTISSEMENT
	Afin de réduire le risque d'électrocution, ne pas retirer ou ouvrir le capot. Aucune pièce réparable ne se trouve à l'intérieur. Confier le dépannage à du personnel qualifié. Débrancher l'alimentation électrique avant réparation.

IMPORTANT

Utilisation de la documentation client

- La documentation client fait partie du four mixte.
- Garder les manuels d'utilisation de la documentation client à votre disposition, pour consultation à tout moment.
- Conserver les manuels de la documentation client sur toute la durée de vie de l'appareil.
- Veuillez lire soigneusement le manuel d'installation et le manuel d'utilisation avant de manipuler cet appareil.
- En cas de cession du four mixte, joindre à celui-ci les manuels de la documentation client.



Table of contents

Safety symbols used in this document or on appliance.....	2
Symboles de sécurité utilisés dans ce document ou sur appareil	3
Document information	9
Section 1: Safety	10
1A. Environmental protection	12
Statement of principles	12
Environmental protection procedures	12
1B. Identifying your microwave combination oven.....	13
Position of nameplate.....	13
1C. General safety / Sécurité générale.....	14
Basic safety code.....	14
IMPORTANT SAFETY INSTRUCTIONS	16
CONSIGNES DE SÉCURITÉ IMPORTANTES	18
Other safety considerations and instructions.....	20
1D. Summary of design, operational hazards and safety devices.....	23
Warning and safety signs	23
Parts and safety devices.....	24
Hazard points.....	26
Risques	26
Intended use of your microwave combination oven	27
1E. Requirements to be met by operating personnel working positions	29
1F. Hazards and safety precautions during installation and setting up	30
Personal protective equipment requirement	30
Safety precautions relating to the installation location.....	30
Grounding instructions.....	31
Instructions de mise à la terre	31
Potential risks during installation and setting up	31
1G. Hazards and safety precautions when preparing appliance for use	33
Personal protective equipment requirement	33
Safety precautions for preparation for first use	33
1H. Hazards and safety precautions during operation.....	34
Personal protective equipment requirement	34
General rules.....	34
Restrictions on use	34
Instructions for safe use of the appliance.....	34
Potential risks during operation	35



	Risques potentiels pendant l'utilisation	36
1I.	Hazards and safety precautions during cleaning	38
	Personal protective equipment requirement	38
	General cleaning safety rules and requirements	38
	Potential risks during cleaning.....	38
1J.	Hazards and safety precautions during servicing and repair	40
	Personal Protective Equipment	40
	Potential risks to move appliance	40
	Rules for moving and setting up the wheeled trolley safely	40
	Risk of burns.....	41
1K.	Hazards and safety precautions when taking the appliance out of service	42
	Personal protective equipment	42
	General precautions.....	42
	Potential risks.....	42
	Section 2: Operations and Installation	43
2A.	Introduction to e1s	44
	Identifying your microwave combination oven	44
	Appliance parts and their functions	45
	Equipment and accessories supplied	46
2B.	Installing the appliance	47
	Unpacking.....	47
	Taking the appliance off the pallet.....	47
	Installation location requirements	48
	Electrical installation requirements	49
2C.	Getting started.....	51
	Fitting the air filter.....	51
	Inserting the cook plate	51
	Turning the oven on and off.....	51
	Settings on first usage.....	52
	Selecting suitable utensils.....	53
	Preheating the oven	53
	Understanding the main menu and keyboard.....	54
2D.	Cooking procedures.....	55
	How to cook	55
	Using a cooking profile – quick serve mode	56
	Using a cooking profile – full serve mode	57
	Choosing cooking profiles for Press&Go menu.....	58
	Changing the cavity temperature	59



2E.	Cooking profiles.....	60
	Creating a cooking profile	60
	Viewing and editing cooking profiles.....	61
	Moving a cooking profile in a group of cooking profiles.....	61
	Moving a cooking profile in a list	62
	Adding a new cooking profile group.....	62
	Adding a cooking profile to a group of cooking profiles.....	63
	Deleting a cooking profile group	63
	Editing a selected cooking profile group name.....	64
2F.	Changing settings	65
	Changing settings process.....	65
	Operating mode / navigation settings.....	66
	Language settings.....	66
	Cavity temperature settings and labels	67
	Service information and error logs	68
	Cooking profile counters.....	68
	Setting the date and time.....	69
	Sound settings.....	70
	Temperature timer setting.....	71
	USB programme downloads	72
	Temperature band setting.....	73
	Change setting / service access password.....	73
	Set screen saver	74
2G.	Cool-down procedures	75
2H.	Cleaning procedures.....	76
	Daily cleaning tasks.....	76
	Cleaning instructions.....	77
2I.	End of day operations.....	80
	Turning the oven off.....	80
2J.	Servicing information	81
	Warranty information and contacting customer services	81
	Fault finding.....	82



Document information

Version control

Date	Issue number	Description	Issued by
24 January 2020	02	Safety instructions, operation and installation procedures for eikon e1s	Merrychef

Document purpose

This document should be read prior to installing and using the appliance.

This document is intended for all people who work with the Merrychef eikon e1s microwave combination ovens, and provides them with the necessary information to operate and maintain them safely.

This document must be read and understood without fail by those that will come in to contact with the appliance. If the information is not followed, there is risk of fatality, injury and property damage.



Section 1: Safety



Important information / Information importante

Users are cautioned that maintenance and repairs should be performed by a Merrychef authorized service agent using genuine Merrychef replacement parts. Merrychef will have no obligation with respect to any product that has been improperly installed, adjusted, operated or not maintained in accordance with national and local codes or installation instructions provided with the product, or any product that has its serial number defaced, obliterated or removed, or which has been modified or repaired using unauthorized parts or by unauthorized service agents. For a list of authorized service agents please refer to your distributor.

Les utilisateurs sont avisés que l'entretien et les réparations devraient être effectués par un agent de service autorisé de Merrychef utilisant des pièces de rechange d'origine Merrychef. Merrychef rejette toute responsabilité relativement à tout produit qui a été installé, ajusté, utilisé incorrectement ou qui n'est pas entretenu conformément aux codes fédéraux, provinciaux et locaux ou aux instructions d'installation fournies avec l'appareil, ou à tout produit dont le numéro de série a été abîmé, effacé ou enlevé, ou qui a été modifié ou réparé en utilisant des pièces non-autorisées ou par des agents de service non-autorisés. Pour la liste des agents de service autorisés, se référer à la dernière page de ce manuel. Les renseignements contenus dans ce manuel (incluant les spécifications de la conception et des pièces) peuvent être remplacés et sont sous réserve de changements sans préavis.



1A. Environmental protection

Welbilt employs a quality management system in accordance with EN ISO 9001:2008 and a certified environmental management system in accordance with EN ISO 14001.

Statement of principles

Our customers' expectations, the legal regulations and standards and our company's own reputation set the quality and service for all our products.

We have an environmental management policy that not only ensures compliance with all environmental regulations and laws, but also commits us to continuous improvement of our green credentials.

We have developed a quality and environmental management system to guarantee the continued manufacture of high-quality products and to be sure of meeting our environmental targets.

This system satisfies the requirements of ISO 9001:2008 and ISO 14001:2004.

Environmental protection procedures

We observe the following procedures:

- Use of RoHS2-compliant products
- REACH chemical law
- Recycling of electronic waste
- Environmentally friendly disposal of old appliances via the manufacturer



1B. Identifying your microwave combination oven

Position of nameplate

The nameplate is located on the rear of your microwave combination oven and contains various pieces of information as detailed below.

	No	Item
	1	Model Number
	2	Serial Number <ul style="list-style-type: none"> • Year of manufacture • Month of manufacture • Place of manufacture • Production number
	3	Regulatory Compliance <ul style="list-style-type: none"> • WEEE • CE • NFPA Ventilation Compliance • UL/Canada
	4	Technical Data <ul style="list-style-type: none"> • Supply Voltage • Maximum Phase Current • Maximum Power Supply • Output Microwave Power • Output Convected Power • Microwave Frequency
5	Design and Production Details: <ul style="list-style-type: none"> • Designed by • Manufacturing Site • Brand HQ details 	

Figure 1.1: Nameplate



1C. General safety / Sécurité générale

The information in this section should be read and understood by Facility Managers, Chefs, Users and Service Technicians.

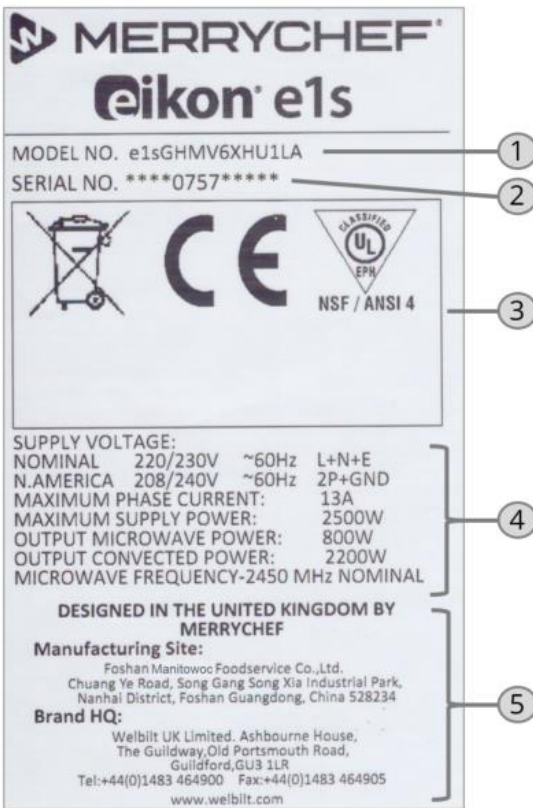
Basic safety code

Object of this safety code

This safety code aims to ensure that all persons who use the microwave combination oven have a thorough knowledge of the hazards and safety precautions, and that they follow the warning notices given in the Installation and User manual and on the appliance. If you do not follow this safety code, you risk potentially fatal injury and property damage.

Referring to the Installation and Operation Manual

Follow the instructions below:

- Read in full Section 1C of this Safety Guide and the chapters that relate to your work.
- Pass on the Operations and Installation Guide with the microwave combination oven if it changes ownership.

Personal protective equipment for your personnel

Instruct your personnel to wear the correct personal protective equipment specified for each task in the relevant sections.

Basic rules for installation

The appliance must be installed in compliance with all national and state laws and regulations, with all applicable local requirements and regulations set forth by the relevant local utility companies and authorities, and with all other relevant regulations and standards.

These include, but are not limited to:

- The National Electrical Code, ANSI/NFPA 70 (current edition)
- The Canadian Electrical Code, CSA C22.1
- The Food Code and Food Service Sanitation Manual published by the Food and Drug Administration (FDA) (current editions)
- The standards published by the National Sanitation Foundation (NSF)
- All local fire protection and occupational health and safety regulations

Règles de base pour l'installation

L'installation doit s'effectuer conformément à toutes les lois et prescriptions étatiques et fédérales, ainsi qu'aux prescriptions locales des opérateurs et autorités locales ainsi qu'aux autres directives applicables.

Outre les autres prescriptions doivent également être respectés:

- National Electrical Code, ANSI/NFPA 70 (édition actuelle)
- Canadian Electrical Code, CSA C22.1
- Food Code et Food Service Sanitation Manual de la Food and Drug Administration (FDA) (édition actuelle respective)



- Prescriptions de la National Sanitation Foundation (NSF)
- Toutes les prescriptions en matière de protection incendie, sécurité au travail et protection sanitaire

Working with the microwave combination oven

Follow the instructions below:

- Only those persons who satisfy the requirements stipulated in this Safety Guide are permitted to use the microwave combination oven.
- Only use the microwave combination oven for the specified use. Never, under any circumstances, use the microwave combination oven for other purposes.
- Take all the safety precautions specified in this Safety Guide and on the microwave combination oven. In particular, use the prescribed personal protective equipment.
- Only stand in the working positions specified.
- Do not make any changes to the microwave combination oven, e. g. removing parts or fitting un-approved parts. In particular, you must not disable any safety devices.



IMPORTANT SAFETY INSTRUCTIONS

All appliances

When using electrical appliances, basic safety precautions should be followed including the following.

WARNING – To reduce the risk of burns, electric shock, fire, injury to persons, or exposure to excessive microwave energy:

- 1) Read all instructions before using the appliance.
- 2) Read and follow the specific 'PRECAUTIONS TO AVOID POSSIBLE EXPOSURE TO EXCESSIVE MICROWAVE ENERGY' on page 4.
- 3) The appliance must be grounded. Connect only to a properly grounded outlet. See 'Grounding instructions' in Section 1F.
- 4) Install or locate this appliance only in accordance with the provided installation instructions.
- 5) Some products such as whole eggs and sealed containers – for example, closed glass jars – are able to explode and should not be heated in this oven.
- 6) Use this appliance only for its intended use as described in the manual. Do not use corrosive chemicals or vapors in this appliance. This type of oven is specifically designed to heat, cook or toast food. It is not designed for industrial or laboratory use.
- 7) **HOT CONTENTS CAN CAUSE SEVERE BURNS. DO NOT ALLOW CHILDREN TO USE THE MICROWAVE.** Use caution when removing hot items.
- 8) Do not operate this appliance if it has a damaged door, cord or plug, if it is not working properly, or it has been damaged or dropped.
- 9) This appliance should be serviced only by qualified service personnel. Contact nearest authorized service facility for examination, repair, or adjustment.
- 10) Do not block or cover any openings on the appliance.
- 11) Do not store this appliance outdoors. Do not use this product near water, for example, near a kitchen sink, in a wet basement, near a swimming pool, or similar locations.
- 12) Do not immerse cord or plug in water
- 13) Keep cord away from heated surfaces
- 14) Do not let cord hang over edge of table or counter



15) When cleaning surfaces of door and oven that come together on closing the door see the instructions on cleaning the door surface in the Operations and Installation Guide – Section 2H.

16) To reduce the risk of fire in the oven cavity

- i. Do not overcook food. Carefully attend appliance when paper, plastic, or other combustible materials are placed inside the oven to facilitate cooking.
- ii. Remove wire twist-ties from paper or plastic bags before placing a bag in the oven.
- iii. If materials inside the oven ignite, keep the oven door closed. Turn the oven off, and disconnect the supply cord, or shut off power at the fuse or circuit breaker panel.
- iv. Do not use the cavity for storage purposes. Do not leave paper products, cooking utensils or food in the cavity when not in use.

17) Liquids, such as water, coffee or tea are able to be overheated beyond the boiling point without appearing to be boiling. Visible bubbling or boiling when the container is removed from the microwave combination oven is not always present. THIS COULD RESULT IN VERY HOT LIQUIDS SUDDENLY BOILING OVER WHEN THE CONTAINER IS DISTURBED OR A UTENSIL IS INSERTED INTO THE LIQUID.

Combination microwave ovens

- 1) Oversized foods or oversized metal utensils should not be inserted in a microwave oven as they may create a fire or risk of electric shock.
- 2) Do not clean with metal scouring pads. Pieces can burn off the pad and touch electrical parts involving a risk of electric shock.
- 3) Do not store any materials, other than the manufacturer's recommended accessories in this oven when not in use.
- 4) Do not cover racks or any other part of the oven with metal foil. This will cause overheating of the oven.

SAVE THESE INSTRUCTIONS



CONSIGNES DE SÉCURITÉ IMPORTANTES

Tous les appareils

Lorsque vous utilisez des appareils électriques, des précautions de sécurité de base doivent être observées, notamment.

AVERTISSEMENT – Afin de réduire le risque de brûlures, de choc électrique, d'incendie, de blessure ou d'exposition à un excès d'énergie dégagée par les micro-ondes :

- 1) Lire l'ensemble des instructions avant d'utiliser l'appareil.
- 2) Lire et respecter plus précisément les "PRÉCAUTIONS À PRENDRE POUR ÉVITER TOUTE EXPOSITION POTENTIELLE À UN EXCÈS D'ÉNERGIE DÉGAGÉE PAR LES MICRO-ONDES" en page 5.
- 3) L'appareil doit être mis à la terre. Le raccorder uniquement à une prise secteur correctement mise à la terre. Voir "Instructions de mise à la terre" dans la Section 1F.
- 4) N'installer ou ne positionner cet appareil que dans le respect des instructions d'installation fournies.
- 5) Certains produits tels que les œufs entiers et récipients étanches – par exemple, flacons en verre fermés – sont susceptibles d'exploser et ne doivent pas être chauffés dans ce four.
- 6) N'utiliser cet appareil que pour son usage prévu décrit dans le manuel. Ne pas utiliser de produits chimiques corrosifs ni de vapeurs dans cet appareil. Ce type de four est conçu spécialement pour chauffer, cuire ou griller des aliments. Il n'est pas conçu pour une utilisation industrielle ou pour être utilisé en laboratoire.
- 7) LES CONTENUS TRÈS CHAUDS PEUVENT CAUSER DES BRÛLURES GRAVES. N'AUTORISEZ PAS LES ENFANTS À UTILISER LE FOUR À MICRO-ONDES. Faites preuve de prudence quand vous sortez des aliments très chauds.
- 8) Ne pas utiliser cet appareil si la porte, le cordon ou la fiche est endommagé, s'il ne fonctionne pas correctement, s'il a été endommagé ou a subi une chute.
- 9) Cet appareil ne doit être réparé que par du personnel de service après-vente qualifié. Contacter le site de service après-vente agréé le plus proche pour examen, réparation ou réglage.
- 10) Ne pas obstruer ni couvrir toute ouverture de l'appareil.
- 11) Ne pas entreposer cet appareil à l'extérieur. Ne pas utiliser ce produit près de l'eau, par exemple près d'un évier, dans un sous-sol humide, près d'une piscine ou dans des lieux comparables.



- 12) Ne pas immerger le cordon ni la fiche dans l'eau
- 13) Conserver le cordon à l'écart des surfaces chaudes
- 14) Ne pas laisser le cordon pendre au bord d'une table ou d'un plan de travail
- 15) Lors du nettoyage des surfaces de la porte et du four qui entrent en contact à la fermeture de la porte, voir les instructions de nettoyage de la surface de la porte dans le Guide d'installation et d'utilisation – Section 2H.
- 16) Pour réduire le risque d'incendie dans l'enceinte du four
 - i. Ne pas cuire excessivement les aliments. Surveiller attentivement l'appareil en cas d'insertion de papier, plastique ou autre matière combustible à l'intérieur du four pour faciliter la cuisson.
 - ii. Retirer les liens torsadés des sachets en papier ou en plastique avant de placer un sachet dans le four.
 - iii. En cas d'inflammation de matière à l'intérieur du four, maintenir la porte du four fermée. Arrêter le four, débrancher le cordon d'alimentation ou couper l'alimentation au fusible ou disjoncteur du tableau.
 - iv. Ne pas utiliser l'enceinte pour l'entreposage. Ne pas laisser de produits en papier, ustensiles de cuisine ou aliments dans l'enceinte hors utilisation.
- 17) Les liquides tels que l'eau, le café ou le thé peuvent surchauffer au-delà du point d'ébullition sans sembler bouillir. Les bulles ou l'ébullition ne sont pas toujours visibles à l'enlèvement du récipient du four combiné à micro-ondes. CECI PEUT CONDUIRE À CE QUE DES LIQUIDES TRÈS CHAUDS SE METTENT SOUDAIN À BOUILLIR LORS D'UNE PERTURBATION DU RÉCIPIENT OU À L'INSERTION D'UN USTENSILE DANS LE LIQUIDE.

Four combiné à micro-ondes

- 1) Des aliments trop grands ou ustensiles métalliques de grande dimension ne doivent pas être insérés dans un four à micro-ondes car ils risquent de créer un incendie ou un risque de choc électrique.
- 2) Ne pas nettoyer avec des tampons de récurage métalliques. Des morceaux pourraient se détacher du tampon et toucher des pièces électriques, ce qui présenterait un risque de choc électrique.
- 3) Ne pas entreposer de matières autres que les accessoires recommandés par le constructeur dans ce four quand il n'est pas en cours d'utilisation.
- 4) Ne pas recouvrir les clayettes ni toute autre partie du four de feuille métallique. Ceci ferait surchauffer le four.

CONSERVER CES INSTRUCTIONS



Other safety considerations and instructions

General cautions

⚠ WARNING

- Installation of the microwave combination oven must comply with all national and regional laws and regulations as well as the local regulations of the relevant utility companies and local authorities along with any other related requirements.
- This appliance is not intended for mobile use, such as in marine or vehicle applications.
- Changes should not be made to the microwave combination oven, e.g. removing parts or fitting unapproved parts. In particular, the safety devices should never be disabled.
- Always keep at hand the *Operations and Installation Guide* for reference and pass it to the new user if the oven changes ownership.

Restrictions on use

- Never use the appliance to heat alcohol, e. g. brandy, rum, etc. Food containing alcohol can more easily catch fire if overheated. Observe caution and do not leave the appliance unattended.
- Never attempt to deep fry in the oven.
- Do not operate the appliance using microwave only or combination function without food or liquid inside the cooking chamber as this may result in overheating and may cause damage.
- The appliance should not be used to dry linen.
- Do not store any materials, other than the manufacturer's recommended accessories in this oven when not in use.

⚠ WARNING

- Liquids or other foods must not be heated in sealed containers or jars since they are liable to explode.

⚠ WARNING

- When handling hot liquids, foods and containers, care should be taken to avoid scalds and burns.

Instructions for safe use of the appliance

- When handling hot liquids, foods and containers, care should be taken to avoid scalds and burns.
- As with any cooking appliance, care should be taken to avoid combustion of the items within the appliance.
- Only use utensils that are suitable for use in microwave combination ovens.
- Foods must not be heated in completely sealed containers as the build-up of steam may cause them to explode.
- Items should be unwrapped when using convection and combination functions.
- Excess fat should be removed during 'roasting' and before lifting heavy containers from the oven.
- Food with a skin, e. g. potatoes, apples, sausages, etc. should be pierced before heating.
- In the event of glass breaking or shattering within the oven, ensure that food is totally free of glass particles. If in doubt, dispose of any food that was in the oven at the time of the breakage.
- Food in combustible plastic or paper containers should be transferred to a microwave/oven proof container to avoid the possibility of ignition.



- Do not use paper products when appliance is operated in the toaster mode.
- Oversized foods or oversized metal utensils should not be inserted in a microwave/toaster oven as they may create a fire or risk of electric shock.
- Do not cover racks or any other part of the oven with metal foil. This will cause overheating of the oven.
- Switch off the appliance at the end of all the cooking sessions for that day.
- Extra precautions must be taken when heating and handling liquid:

⚠ CAUTION

- When heating liquids using microwave only or combination function, the contents should be stirred prior to heating to help prevent eruptive boiling.
- Only use containers of appropriate size.
- Insert the food containers correctly.
- Always place containers holding liquids or holding food that will liquefy during cooking on shelves that allow a proper view into the container for all users.
- Always take out horizontally any containers holding liquids or holding food that will liquefy during cooking.

⚠ WARNING

- The contents of feeding bottles and baby food jars must be stirred or shaken and the temperature checked before consumption to avoid burns.

Safe operating requirements

⚠ WARNING

- This appliance is not intended for use by persons with reduced physical sensory or mental capabilities or lack of experience and knowledge unless they have been given supervision or instruction concerning use of the appliance in a safe way and understand the hazards involved.
- As with all electrical appliances, it is recommended to have the electrical connections inspected at least once a year.

- **⚠ DANGER** If the supply cord is damaged, it must be replaced by the manufacturer, its service agent or similarly qualified persons in order to avoid a hazard.

- **⚠ DANGER** The appliance must be disconnected from its power supply during maintenance and when replacing parts.
 - Unplug appliance such that from any access point the operator can check the plug remains removed.
 - Use of disconnection with a locking system in the isolated position is recommended in order to avoid a hazard.

⚠ WARNING If the door or door seals are damaged, the oven must not be operated until it has been repaired by a competent person. See *Section 1E – Requirements to be met by a operating personnel working position.*

⚠ DAMAGE

- The minimum space requirements specified in this guide to install and operate the appliance must be followed. See *Section 1F.*
- Ensure dry floor. The floor adjacent to the appliance may be slippery. Clean up spillages immediately.



Cleaning safely requirements

- Personnel charged with cleaning must be trained regularly by the person responsible for the microwave combination oven.
- The oven should be cleaned regularly and any food deposits removed.
- The oven must already be cool or cooled down following the correct procedures specified in the *Section 2G*.
- Use only cleaning chemicals that have been approved by the manufacturer.
- High-pressure cleaners or water jets must not be used for cleaning.
- The appliance must not be treated with alkali or acid solutions or exposed to acid fumes.
- The cooking chamber of the appliance and the door seals should be cleaned frequently. Failure to maintain the appliance in a clean condition could lead to deterioration of the surface, which could adversely affect the life of the appliance and possibly result in a hazardous situation. Details for cleaning door seals, cavities and adjacent parts are provided in *Section 2H*.
- Ensure that the cavity has been cleaned thoroughly of any cleaning agents with warm water, then wipe with a soft cloth or paper towel.
- Do not clean with metal scouring pads. Pieces can burn off the pad and touch electrical parts involving a risk of electric shock.
- The air filter (Figure 1.3, item 7) is part of the ventilation system and should be cleaned daily.
- Do not heat up the appliance if there are cleaning chemicals inside.



Full cleaning procedures are detailed in Section 2H.

Emergency instructions

⚠ DANGER

- If smoke is observed, switch off the appliance. Unplug or isolate it from the electrical supply and keep the door closed in order to stifle any flames.



1D. Summary of design, operational hazards and safety devices

The information in this section should be read and understood by Facility Managers, Chefs, Users and Service Technicians.

The microwave combination oven is designed to protect the user from all hazards that can reasonably be avoided by design measures. The actual purpose of the microwave combination oven, however, means that there are still residual risks; you must therefore take precautions to avoid them. A safety device can provide you with a certain degree of protection against some of these hazards. You must ensure, however, that these safety devices are in place and in working order.

Le four combiné à micro-ondes est conçu pour protéger l'utilisateur de tous les risques pouvant raisonnablement être évités à l'aide de dispositions de conception. L'objet même du four combiné à micro-ondes ne peut cependant exclure les risques résiduels ; c'est pourquoi il convient de prendre des précautions pour les éviter. Un dispositif de sécurité peut vous offrir un certain degré de protection contre certains de ces risques. Vous devez cependant vous assurer que ces dispositifs de sécurité sont en place et en état de marche.

Warning and safety signs

The following warning signs/notices must be attached to the microwave combination oven and optional accessories in the area indicated so as to be easily visible at all times.

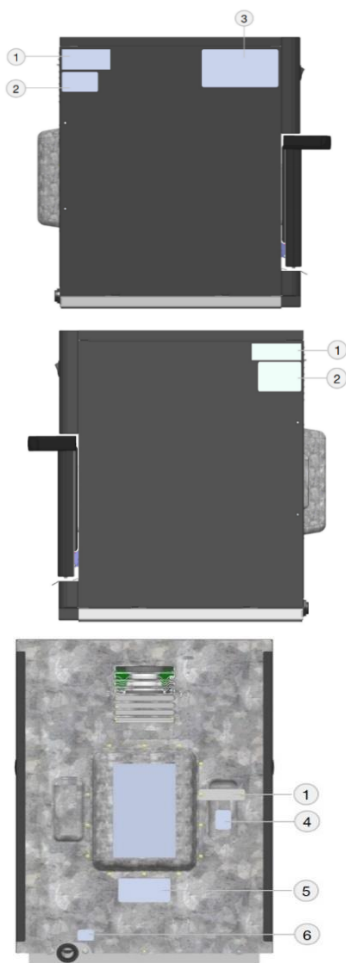

Area	Symbol	Descriptions
1		Microwaves warning There is a risk of external and internal burns of body parts following exposure to microwave energy.
2		Electric shock warning There is a risk of electric shock if the appliance is serviced without disconnecting the electrical supply.
3		Fire / electric shock warning There is a risk of fire / electric shock if the appliance is operated without respecting the minimum clearances.
4		Hot surface warning There is a risk of burns from high temperatures inside the cavity and on the inside of the appliance door.
5		Electric shock warning There is a risk of electric shock if the electrical power is not connected to a properly grounded outlet.
6		Equipotential bonding

Table 1.1: Meaning of signs

Figure 1.2: Warning and safety signs on appliance



Parts and safety devices

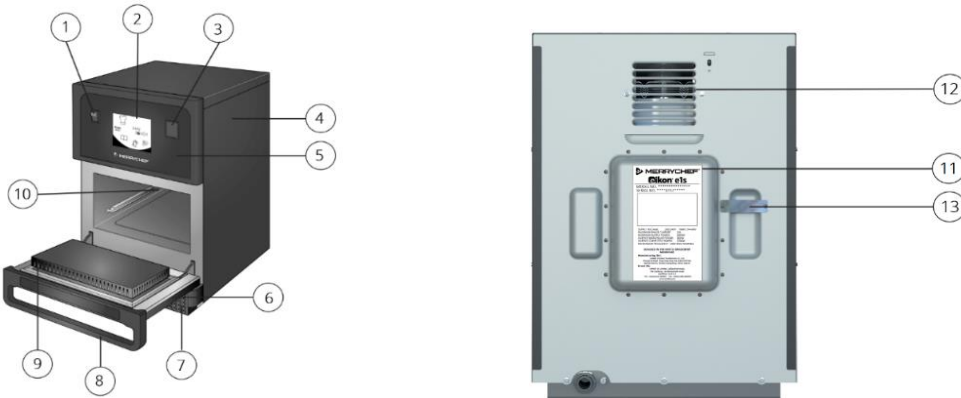

Figure 1.3: e1s front and rear views – parts and safety devices

Item	Part / safety device	Function and precautions
1	ON/OFF appliance switch	Used to turn the microwave combination oven on and off. However, turning this switch off does not isolate the appliance from the electricity supply.
2	easyToUCH® screen control panel	The easyToUCH® screen illuminates to alert the user that the appliance is switched on.
3	USB port	A USB socket located under the cover allows updates to programmes stored on the appliance.
4	Protective cover	The cover can only be removed with specific tools. It prevents live parts from being touched accidentally and prevents access to the moving fan. Always ensure the cover is securely in place.
5	Operating panel	Can only be removed using specific tools and prevents live parts from being touched accidentally. Always ensure the panel is in place.
6	Appliance door	Protects the user and outside environment from hot steam and microwave energy. Check the door regularly for damage and replace it if required.
7	Air filter	The air filter is part of the ventilation system and should be free of obstruction and cleaned daily.
8	Door handle	The door handle is a rigid bar which is pulled downwards and away from the appliance to open it.
9	Door seals	The tight seals around the door ensure protection from microwave energy leaking from the cavity. Check the door seals regularly for signs of damage and replace it if required.
10	Cavity	The cavity (cooking chamber) is constructed from stainless steel and used for cooking products. Keep it clean by following the appliance's cleaning procedures.
11	Nameplate	A label that is attached at the rear of the oven and states the serial number, model type and electrical specifications.
12	Air outlets	Air used to cool internal components and allow steam from the cavity to escape. The air outlets must be kept free from obstruction and they will not allow microwave energy to escape into the environment.
13	Steam pipe and cover	A covered pipe from the cavity to the back of the oven to vent steam during cooking and prevent pressure build up.

Table 1.2: Parts – functions and precautions



Other safety devices

Safety device	Functions	Checks / Actions
Door interlocks - Electric door sensor for appliance door	<ul style="list-style-type: none"> Ensures that the microwave generation system cannot be powered when the door is open 	<p>Check door switch:</p> <ul style="list-style-type: none"> Action: Open the appliance door fully and press Start Result: Door open warning message
Disconnection device	<ul style="list-style-type: none"> Installed by the customer close to the appliance; easily visible and accessible, 1- or 3-pole action, minimum contact separation 3mm Used to disconnect the appliance from the power supply during cleaning, repair and servicing work and in case of danger 	<p>Action:</p> <ul style="list-style-type: none"> Trip the disconnection device Unplug appliance such that from any access point the operator can check the plug remains removed Use of disconnection with a locking system in the isolated position
Internal fuses	<ul style="list-style-type: none"> Prevent faulty components from drawing too much current and causing potential fire hazard 	<ul style="list-style-type: none"> Ensure that the internal fuses are correctly rated

Table 1.3: Safety devices - actions and checks



Hazard points

Heat generation (1)

The microwave combination oven becomes hot inside the cavity and on the inside of the appliance door. This poses a risk of burns on hot surfaces inside the microwave combination oven, and also on hot appliance parts, food containers and other accessories used for cooking.

Hot steam / vapor (2)

When cooking food, the microwave combination oven may generate hot steam and vapor which escapes when the appliance door is opened and which is removed through the air vents on the rear of the microwave combination oven when the appliance door is closed. This poses a risk of scalding from hot steam when the appliance door is opened. Take particular care when opening the appliance door if the top door edge is below your field of vision.

Live components (3)

The microwave combination oven contains live parts. This means a risk from live parts if the cover is not in place.

Parts moving against each other (4)

For various actions, such as opening/shutting the appliance door or cleaning the appliance door, there is the risk that you will crush or cut your hand.

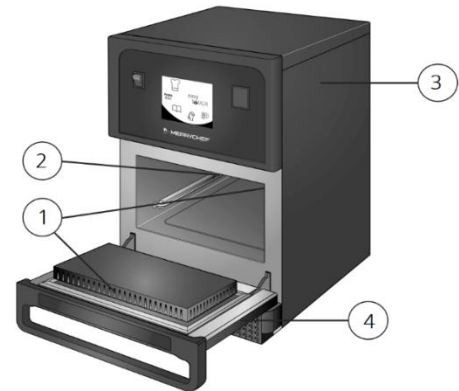

Figure 1.4: Hazard points

Risques

Production de chaleur (1)

Le four combiné à micro-ondes devient chaud dans l'enceinte de cuisson et sur la face intérieure de la porte de l'appareil. Cela pose un risque de brûlure sur les surfaces chaudes à l'intérieur du four combiné à micro-ondes et aussi sur les parties chaudes de l'appareil, les récipients alimentaires et autres accessoires utilisés pour la cuisson.

Vapeur d'eau chaude / fumées (2)

Lors de la cuisson des aliments, le four combiné à micro-ondes peut produire de la vapeur d'eau chaude et des fumées s'échappant lorsque la porte de l'appareil est ouverte et qui sont éliminées par les orifices d'évacuation situés à l'arrière du four combiné à micro-ondes lorsque la porte de l'appareil est fermée. Cela pose un risque de brûlure par vapeur chaude à l'ouverture de la porte de l'appareil. Faire particulièrement attention lors de l'ouverture de la porte de l'appareil si le bord supérieur de la porte se situe en-dessous de votre champ de vision.

Composants sous tension (3)

Le four combiné à micro-ondes contient des pièces sous tension. Cela implique un risque engendré par les pièces sous tension si le capot n'est pas en place.

Pièces mobiles les unes par rapport aux autres (4)

Lors de différentes actions telles que ouvrir/fermer la porte de l'appareil ou nettoyer celle-ci, il existe un risque de s'écraser ou de se couper la main.

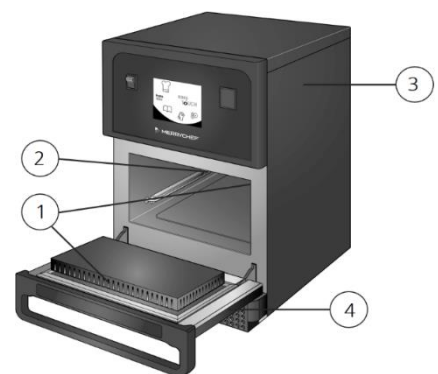

Figure 1.5 : Risques

Intended use of your microwave combination oven

The microwave combination oven must only be used for the purposes specified below:

- The microwave combination oven is designed and built solely for cooking different foodstuffs in containers approved by the manufacturer. Microwave, convection and impingement are used for this purpose.
- The microwave combination oven is intended solely for professional, commercial use.

Restrictions on use

Some materials are not allowed to be heated in the microwave combination oven:

- No dry powder or granulated material.
- No highly flammable objects with a flash point below 270°C / 518°F, such as highly flammable oils, fats or cloths (kitchen cloths).
- No food in sealed tins or jars.

Requirements to be met by personnel

- The microwave combination oven must only be operated and installed by personnel who satisfy specific requirements. Please refer to *Section 1E - Requirements to be met by personnel, working positions* for the training and qualifications requirements.
- Personnel must be aware of the risks and regulations associated with handling heavy loads.

Requirements relating to the operating condition of the microwave combination oven

- Do not operate the microwave combination oven unless it has been properly transported, set up, installed and placed into operation as indicated in this manual and the person responsible for placing it into operation has confirmed this.
- The microwave combination oven must only be operated when all safety devices and protective equipment are fitted, in working order and fixed properly in place.
- The manufacturer's regulations for operation and servicing of the microwave combination oven must be observed.

Requirements relating to the operating environment of the microwave combination oven

Specified operating environment for the microwave combination oven:

- The ambient temperature lies between +4°C / 40°F and +35°C / 95°F
- Not a toxic or potentially explosive atmosphere
- Dry kitchen floor to reduce the risk of accidents

Specified properties of the installation location:

- No fire alarm, no sprinkler system directly above the appliance
- No flammable materials, gases or liquids above, on, under or in the vicinity of the appliance
- It must be possible to set up the microwave combination oven in the installation position so that it cannot tip over or slide about. The supporting surface must comply with these requirements.

Mandatory restrictions on use:

- The appliance must not be operated outdoors and not be shifted or moved during use.



Cleaning requirements

- Use only cleaning chemicals that have been approved by the manufacturer.
- High-pressure cleaners or water jets must not be used for cleaning.
- The appliance must not be treated with alkali or acid solutions or exposed to acid fumes.



1E. Requirements to be met by operating personnel working positions

The information in this section should be read and understood by Facility Managers, Chefs, Users and Service Technicians.

Personnel	Qualifications	Tasks
Facility Manager	<ul style="list-style-type: none"> • Has relevant professional training • Trained in how to operate the microwave combination oven 	<p>Responsible for staff safety. To guarantee safety:</p> <ul style="list-style-type: none"> • Only personnel who demonstrably understand the hazards detailed in this section and strictly follow the precautions and proper usage of instructions provided should be permitted to use the microwave combination oven • Ensure ALL personnel coming in to contact with the microwave combination oven use the Personal Protective Equipment for each task as detailed in this guide
Chef	<ul style="list-style-type: none"> • Has relevant professional training • Knows relevant national food legislation and regulations, plus hygiene legislation and regulations • Must keep records in accordance with Hazard Analysis and Critical Control Points (HACCP) • Trained in how to operate the microwave combination oven 	<p>Essentially performs organizational tasks such as:</p> <ul style="list-style-type: none"> • Entering the cooking profile data • Editing existing cooking profiles in the cookbook • Developing new cooking profiles • Adjusting appliance settings • They may also perform all user tasks if applicable
User	<ul style="list-style-type: none"> • Semi-skilled • Trained in how to operate the microwave combination oven • Works under supervision • Knows the regulations associated with handling heavy loads 	<p>Essentially performs specific operating tasks such as:</p> <ul style="list-style-type: none"> • Loading the microwave combination oven • Starting a cooking profile • Removing food • Cleaning the microwave combination oven. • Fitting accessories in the microwave combination oven • Minor servicing tasks
Equipment mover	<ul style="list-style-type: none"> • Trained in the use of a pallet truck and forklift truck • Knows the regulations associated with handling heavy loads 	<ul style="list-style-type: none"> • Conveying within the establishment
Service technician	<ul style="list-style-type: none"> • Is an authorized service agent • Has relevant technical training • Is trained in the particular appliance • Knows the regulations associated with handling heavy loads 	<ul style="list-style-type: none"> • Setting up the appliance • Preparing the appliance for first-time use and taking the appliance out of service • Instructing the user

Table 1.4: Personnel – qualifications and tasks



1F. Hazards and safety precautions during installation and setting up

The information in this section should be read and understood by Facility Managers, Equipment Movers and Service Technicians.

Personal protective equipment requirement

When installing or moving the appliance, ensure the following personal protective equipment is used:

- Protective gloves
- Safety boots
- Hard hat (e.g. when heavy loads are being lifted and working overhead)

To ensure local and national standards and regulations relating to workplaces in catering kitchens and the installation location are observed, only Service Technicians are permitted to set up the appliance.

Safety precautions relating to the installation location

To prevent hazards that arise from the installation site and environment of the appliances, the following rules must be observed:

- The floor adjacent to the appliance may be slippery. Clean up spillages immediately.
- The location for installation must comply with operating conditions requirements:
 - The ambient temperature lies between +4°C /40°F and +35°C/95°F
 - Not a toxic or potentially explosive atmosphere
 - Dry kitchen floor to reduce the risk of accidents
-  **DAMAGE** Minimum space requirement must be complied with:
 - The minimum height of free space necessary above the top surface of the appliance is 50mm (2").
 - The minimum depth requirement is as follows:
 - Width of appliance = 406.4mm (16")
 - Total depth with door open = 806.9mm (31.8")
 - Counter depth = 499.0mm (19.6")
 - Safety clearance on left-/right-hand side / at rear: 0mm
- The appliance must not be installed directly under a fire alarm or sprinkler system. Fire alarm installations and sprinkler systems must be set up to handle the level of steam and vapor expected to escape from the appliance when the door is opened.
- There is a risk of fire from the heat emitted from hot surfaces. Therefore, flammable materials, gases or liquids must not be located near, on or below the appliance.
- It must be possible to set up the microwave combination oven in the installation position so that it cannot tip over or slide about. The supporting surface must comply with these requirements.
- Vibrations must generally be avoided when using wheeled oven stands or wheeled stacking kits.
- Heat sources in the vicinity must lie at a minimum distance of 500mm (20").



- The appliance must be installed so that there is absolutely no possibility that liquid from the appliance or liquid coming from cooking processes can reach deep-fat fryers or appliances that use hot, uncovered fat. Deep-fat fryers or appliances that use hot, uncovered fat, and which are located in the vicinity must lie at a minimum distance of 500mm / 20in.
- Requirements for supporting surface is met.
 - The supporting surface must be flat and level.
 - The supporting surface must have a non-slip surface.
 - The supporting surface must be able to bear the in-use weight of the appliance, plus the weight of the structure supporting the appliance as follows: 50Hz = 46kg / 101lbs and 60Hz = 45kg / 99lbs.

Grounding instructions

WARNING

Improper use of the grounding plug can result in a risk of electric shock and death.

- This appliance must be grounded. In the event of an electrical short circuit, grounding reduces the risk of electric shock by providing an escape wire for the electric current.
- This appliance is equipped with a cord having a grounding wire with a grounding plug.
- The plug must be plugged into an outlet that is properly installed and grounded.
- Consult a qualified electrician or service technician if the grounding instructions are not completely understood, or if doubt exists as to whether the appliance is properly grounded, and do not use an extension cord.
- If the power supply cord is too short, have a qualified electrician or service technician install an outlet near the appliance.

Instructions de mise à la terre

AVERTISSEMENT

Une utilisation incorrecte de la prise de terre peut conduire à un risque de choc électrique et de décès.

- Cet appareil doit être mis à la terre. En cas de court-circuit électrique, la mise à la terre réduit le risque de choc électrique en fournissant un trajet d'évacuation du courant électrique.
- Cet appareil est équipé d'un cordon avec fil de terre et fiche avec terre.
- La fiche doit être branchée sur une prise installée et mise à la terre correctement.
- Contacter un électricien ou un technicien de service qualifié si vous ne comprenez pas parfaitement les instructions de mise à la terre, ou en cas de doute sur la mise à la terre correcte de l'appareil, et ne pas utiliser de rallonge.
- Si le cordon d'alimentation est trop court, faire poser une prise près de l'appareil par un électricien ou un technicien de service qualifié.

Potential risks during installation and setting up

Risk of injury from lifting heavy weights incorrectly

WARNING

When lifting the appliance, the weight of the appliance may lead to injuries, especially in the torso area. To avoid this:



- Use a fork-lift truck/pallet truck to move the appliance.
- Use suitable lifting gear.
- When lifting the appliance, use enough people for the weight of the appliance (value depending on age and gender). Observe the local occupational safety regulations for lifting and carrying.

Risk of body parts being crushed when moving and setting the appliance down

⚠ WARNING

To avoid crushing body parts, ensure these instructions are followed:

- Use suitable handling gear
- Move the appliance slowly and carefully, and secure it against tipping over
- Make sure centre of gravity is balanced and avoid jolts
- Ensure the supporting surface meets the requirements specified above

Risk of cuts from sharp edges

⚠ CAUTION

To avoid cuts, ensure personal protective equipment is used and exercise caution when handling sheet-metal parts.

Risk of trapping fingers or body in mechanical parts of the appliance

⚠ WARNING

To avoid this risk, when opening or closing the door, ensure that the handle is used and keep clear of the door hinges.

Risk of electric shock from live electrical parts

⚠ DANGER

Live electrical parts are to be found under covers, under the operating panel, along the mains power lead and on metal parts adjacent to the appliance. As such, work on the electrical system must only be performed by qualified electricians (as per EN50110-1 in EU or equivalent) from an authorized service company. To avoid risk:

- The appliance must not be installed or operated outdoors.
- The electrical supply must be connected in accordance with applicable local and national regulations and regulations of the professional associations and of the relevant power supply company.
- Ensure that all electrical connections are in perfect condition and fixed securely.
- Make sure that the appliance is connected to an equipotential bonding system (EU).
- If two microwave combination ovens are installed in a stacking kit, both cases of the appliances and the stacking kit itself must be grounded in a suitable manner and connected to an equipotential bonding system.
- For microwave combination ovens on a wheeled platform, the length of the mains power lead must accommodate the degree of movement allowed to the appliance by the retaining device on the wheeled platform. When moving the assembly (platform plus appliance), never place the mains power lead under tension.
- All electrical connections must be checked when the appliance is prepared for first-time use to ensure cables are laid correctly and connections are made properly.



1G. Hazards and safety precautions when preparing appliance for use

The information in this section should be read and understood by Facility Managers, Chefs, Users and Service Technicians.

Personal protective equipment requirement

Ensure work wear as specified in country-specific standards and directives for kitchen work is used, in particular:

- Protective clothing
- Heat protective gloves (compliant with EN 407 in European Union or equivalent)
- Safety boots

Safety precautions for preparation for first use

- Ensure cardboard packaging and transport securing devices etc. have been removed completely from the appliance.
- Ensure that any work on the electrical system is performed solely by a qualified electrician from an authorized service company.
- Ensure that the appliance, including all metallic accessories, is connected to an equipotential bonding system.
- Ensure all warning signs are in their designated position (Figure 1.2).
- Ensure all safety devices and protective equipment are fitted, are working correctly and are secured properly in place.
- Do not operate the microwave combination oven unless it has been properly transported, set up, installed and placed into operation as indicated in this manual and the person responsible for placing it into operation has confirmed this.
- Do not operate the oven if it is damaged. It is particularly important that the oven door closes properly and that there is no damage to the door, door hinges, door seals and sealing surfaces.
- If the appliance has wheels fitted to the supporting structure, the parking brakes on the front wheels must be engaged when operating the appliance.
- Ensure the air filter situated at the lower front of the appliance (Figure 1.3), is free of obstruction.
- Ensure the air outlets (Figure 1.3) are free from obstruction.



For details of ongoing safety precautions for everyday use, see *Section 1H: Hazards and safety precautions during operation*.



1H. Hazards and safety precautions during operation

The information in this section should be read and understood by Facility Managers, Chefs, Users and Service Technicians.

Personal protective equipment requirement

Ensure work wear as specified in country-specific standards and directives for kitchen work is used, in particular:

- Protective clothing
- Heat protective gloves (compliant with EN 407 in European Union or equivalent)
- Safety boots

General rules

- The appliance must not be operated outdoors.
- The appliance must not be shifted or moved during use.
- The appliance must not be operated without the air filter in place.
- The air filter must always be kept free of obstruction.
- The air outlets must be kept free from obstruction.
- Never hang dish towels or cloths on any part of the appliance.
- Never remove the external covers of the appliance.
- Never remove any fixed internal parts of the appliance.
- Never tamper with the control panel, door, seals, or any other part of the appliance.
- If the door or door seal is damaged, the appliance must not be operated until it has been repaired by a Service Technician.
- The door is a precision-made energy barrier with three microwave safety interlocks. Do not use it to support heavy objects.
- If the supply cord is damaged, it must be replaced by the manufacturer, a Service Technician or similarly qualified person to avoid a hazard.



If smoke is observed at any point, switch off the appliance. Unplug or isolate it from the electrical supply and keep the door closed in order to stifle any flames.

Restrictions on use



The restrictions listed in *Section 1D: General safety* must always be complied with.

Instructions for safe use of the appliance



Section 1D: General safety lists instructions for safe use of the appliance.



Potential risks during operation

Hot surfaces



There is a risk of burn if any of the interior parts of the cavity (Figure 1.3, item 11), the inside of the appliance door or any parts that are or have been inside the oven during cooking are touched. Ensure the personal protective equipment detailed at the beginning of this section is used.

Hot steam / vapor



Escaping hot steam and vapor can cause scalding to face and hands. When opening the door and when cooling the cavity using the 'Cool Down' function, step back from the appliance to avoid the hot steam and vapor escaping through the open door.

Excessive microwave energy



Precautions to avoid burns from excessive microwave energy:

- Do not attempt to operate the appliance oven with the door open, since open-door operation can result in harmful exposure to microwave energy. It is important not to defeat or tamper with the safety interlocks.
- Do not place any object between the oven front face and the appliance door or allow soil or cleaner residue to accumulate on sealing surfaces.
- Do not operate the appliance if it is damaged. It is particularly important that the oven door closes properly and that there is no damage to the door, door hinges, door seals and sealing surfaces.
- The oven should not be adjusted or repaired by anyone except properly qualified service personnel.
- This is a Class A product. In a domestic environment this product may cause radio interference in which case the user may be required to take adequate measures.

Radio interference



This is a Class A product. In a domestic environment this product may cause radio interference in which case the user may be required to take adequate measures.

In case of radio or television interference:

- This equipment generates and uses radio frequency energy and if not installed and operated correctly, in strict accordance with the manufacturer's instructions, may cause harmful interference to authorized radio communication services.
- This product complies with the relevant requirements of CFR 47 Ch.1 Part 18, which are designed to provide reasonable protection against such interference. However, there is no guarantee that interference will not occur in a particular installation. If this equipment does cause interference to radio or television reception, which can be determined by turning the equipment off and on, the user is encouraged to try and correct the interference by one or more of the following measures:
 1. Re-orientate the receiving antenna.
 2. Relocate the microwave combination oven with respect to the receiver.
 3. Plug the microwave combination oven into a different outlet so that the receiver and microwave combination oven are on different branch circuits.



- If necessary the user should consult the dealer or an experienced radio/television technician for additional suggestions.

Note: Modifications should only be carried out by the manufacturer or authorized representative to ensure continuing conformance.

Break in the cold chain

WARNING

To minimize risk of microbiological contamination of foods:

- Never use the appliance for temporary storage of food.
- Never intentionally interrupt the cooking process.
- Once the appliance is running again after a power failure, consider how the length of time taken to resume operation will affect the food condition. If in doubt, discard the food.

Risques potentiels pendant l'utilisation

Surfaces chaudes

AVERTISSEMENT

Il y a un risque de brûlure par contact en touchant toute pièce intérieure de l'enceinte (Figure 1.2, repère 11), l'intérieur de la porte de l'appareil ou toute pièce ayant été à l'intérieur du four pendant la cuisson. S'assurer d'utiliser les équipements de protection individuelle détaillés au début de la présente section.

Vapeur chaude / fumées

AVERTISSEMENT

Les vapeurs chaudes s'échappant peuvent provoquer des échaudures au visage et aux mains. En ouvrant la porte et en refroidissant l'enceinte par la fonction « cool down », reculer d'un pas de l'appareil pour éviter les vapeurs chaudes qui s'échappent par la porte ouverte.

Énergie micro-ondes excessive

AVERTISSEMENT

Précautions pour éviter toute énergie micro-ondes excessive :

- Ne pas tenter de faire fonctionner ce four lorsque la porte est ouverte : cela pourrait entraîner une exposition nocive à l'énergie dégagée par les micro-ondes. Il est important de ne pas toucher aux dispositifs de sécurité.
- Ne laisser en aucun cas un objet entre la face avant du four et la porte, et ne jamais laisser des résidus de nourriture ou de produits d'entretien s'accumuler au niveau des surfaces d'étanchéité.
- Ne pas utiliser l'appareil s'il est endommagé. Il est particulièrement important que la porte du four ferme correctement et que les éléments suivants ne soient pas endommagés : porte, charnières, joints de porte et surfaces d'étanchéité.
- Le four doit être réglé ou réparé exclusivement par des techniciens qualifiés.
- Produit de classe A. Dans un environnement domestique, ce produit peut occasionner des interférences radio imposant à l'utilisateur de prendre des mesures adéquates.



Interférences radio

⚠️ AVERTISSEMENT

Produit de classe A. Dans un environnement domestique, ce produit peut occasionner des interférences radio imposant à l'utilisateur de prendre des mesures adéquates.

⚠️ AVERTISSEMENT

En cas d'interférence avec la radio ou la télévision :

- Cet équipement produit et utilise de l'énergie en fréquence radio et s'il n'est pas installé et utilisé correctement, en respectant strictement les instructions du constructeur, peut causer des interférences nocives aux services de communication radio autorisés.
- Ce produit est conforme aux exigences pertinentes du document CFR 47 Ch.1 Partie 18, conçu pour assurer une protection raisonnable contre de telles interférences. Il n'y a néanmoins aucune garantie que de telles interférences ne surviendront pas dans une installation particulière. Si cet équipement crée des interférences avec la réception de la radio ou de la télévision, ce qui peut être vérifié en éteignant et rallumant l'équipement, l'utilisateur est invité à tenter de corriger l'interférence par une ou plusieurs des mesures suivantes :
 1. Réorienter l'antenne de réception.
 2. Déplacer le four combiné à micro-ondes par rapport au récepteur.
 3. Brancher le four combiné à micro-ondes sur une autre prise de façon que le récepteur et le four combiné à micro-ondes se trouvent sur des circuits électriques différents.
- Si nécessaire, l'utilisateur doit consulter le revendeur ou un technicien expérimenté en radio/télévision pour des suggestions supplémentaires.

Remarque : Les modifications ne doivent être effectuées que par le constructeur ou son représentant agréé pour assurer une conformité permanente.

Rupture de la chaîne du froid

⚠️ AVERTISSEMENT

Pour réduire le risque de contamination microbologique des aliments :

- Ne jamais utiliser l'appareil pour entreposer temporairement de la nourriture.
- Ne jamais interrompre intentionnellement la cuisson.
- Lorsque l'appareil fonctionne à nouveau après une coupure de courant, tenir compte du temps nécessaire à la reprise du fonctionnement sur l'état des aliments. En cas de doute, jeter les aliments.



11. Hazards and safety precautions during cleaning

The information in this section should be read and understood by Facility Managers, Chefs, Users and any other personnel charged with cleaning the appliance.

Personal protective equipment requirement

When cleaning the appliance cavity by hand, and using spray cleaning products, the following personal protective equipment should be used:

- Breathing mask
- Safety goggles
- Protective gloves
- Protective clothing/apron

The specification for these items is provided on the data sheet that should accompany the cleaning products themselves or, where necessary, from the manufacturer directly.

Other cleaning tasks should be carried out in accordance with the instructions given on cleaning and with the personal protective equipment specified by the manufacturer of the cleaning products.

General cleaning safety rules and requirements



See *Section 1D: General safety*. Full cleaning procedures are also detailed in *Section 2: Operations and Installation* and the *Service and Repair Guide*.

Potential risks during cleaning

Risk of electric shock from live parts



Water on the exterior of the appliance can cause a short-circuit, which may result in electric shock on touching the appliance. Therefore:

- Do not spray the interior and exterior of the appliance with water.
- Always keep the USB cover closed during cleaning.

Risk of burns from high temperatures on interior parts of the appliance



There is a risk of burns should any of the following be touched:

- Any of the interior parts of the cavity.
- The inside of the appliance door.
- Any parts that are or have been inside the oven during cooking including racks, shelf grills and baking trays.

To minimize the risk of burns:

- Before starting cleaning tasks, wait until the cavity has cooled to below 50°C / 122°F or use the 'Cool Down' function to cool the cavity as described in *Section 2G: Cool down*.



Risk of scalding from hot steam

⚠ WARNING

If water or cleaning agent is sprayed into the hot cavity, steam will be produced and this may scald. To minimize this risk:

- Before starting cleaning tasks, wait until the cavity has cooled to below 50°C / 122°F or use the 'Cool Down' function to cool the cavity as described in *Section 2G: Cool down procedures*.
- Step back from the appliance to avoid the hot steam and vapor escaping through the open appliance door.

Risk of irritation to skin, eyes and respiratory system from cleaning products

⚠ WARNING

Direct contact with the cleaning or protective chemicals will irritate the skin, eyes and respiratory system. To minimize this risk:

- Do not inhale the vapors or spray mist from the cleaning and protective chemicals.
- Do not let the cleaning or protective chemicals come into contact with skin, eyes or mucous membranes.
- Do not spray cleaning or protective chemicals into a cavity.
- Wear personal protective equipment as detailed at the beginning of this section.



Wearing personal protective clothing is vital throughout the cleaning process and can minimize risks of burns and scalds.

1J. Hazards and safety precautions during servicing and repair

The information in this section should be read and understood by Service Technicians.

Personal Protective Equipment

When repairing or servicing the appliance, ensure work wear and personal protective equipment is used as specified in applicable national regulations. The following personal protective equipment should be used:

- Protective gloves
- Safety boots
- Hard hat (e.g. when heavy loads are being lifted and working overhead)

Potential risks to move appliance

The potential risks associated with service and repair is the same as the possible risks you can be faced with during installation, as both processes may involve lifting and moving the appliance.

The risks are summarized below:

- Electric shock from live electrical parts
- Injury from lifting incorrectly
- Trapping fingers or body in mechanical parts of the appliance
- Cuts from sharp edges
- Crushing if the appliance tips over or falls off



Further information on the above risks and the procedures to avoid them are detailed in *Section 1F. Hazards and safety precautions during installation and setting up.*

Rules for moving and setting up the wheeled trolley safely

The appliance may need to be moved for service and repair. To avoid hazards, the following rules must be observed when moving the wheeled trolley (optional accessory) that carries the appliances:

- Watch out for all connecting cables when moving appliances. Never wheel over the connecting cables. Never pull off or even stretch the connecting cables.
- The appliances must be disconnected from the electrical supply before moving the stacking kit (optional accessory).
- The appliances must be left to cool down on the trolley before being moved.
- There must not be any food left in the appliances.
- The appliance door must be closed.
- Protective clothing must be worn if the appliance is mounted on a trolley.
- It is important to ensure that the unit is level once it is back in place.
- Once the unit is back in place, the parking brakes must be engaged again.
- Whatever the position, care must be taken to ensure that the trolley carrying the appliance does not tip over.



Risk of burns

WARNING

Before starting servicing and repair work, wait until the cooking chamber has cooled to below 50°C / 122°F or use the 'Cool-Down' function (*Section 2H: Cleaning Procedures*) to cool the cooking chamber.

Wear personal protective equipment suitable for handling hot surfaces before touching any of the interior parts of the cooking chamber, the inside of the appliance door or any parts that were inside the oven during cooking.

Risk of burns from microwave emissions

- Do not become exposed to emissions from the microwave generator or parts conducting microwave energy.
- Never operate an appliance that has failed the 'Microwave Leakage test'.

Risk of smoke or fire

If one of the electrical components is defective, for example due to a short-circuit, or if the internal wiring is refitted incorrectly when servicing/repairing the oven, there is a risk of smoke or fire. To avoid this risk:

- Never use electrical spare components which failed a dedicated test or look damaged.
- Carefully refit electrical connections using the wiring diagrams provided in the *Service and Repair Guide*.



1K. Hazards and safety precautions when taking the appliance out of service

The information in this section should be read and understood by Facility Managers and Service Technicians or other suitably qualified service engineer.

Personal protective equipment

When disconnecting the appliance, ensure work wear and personal protective equipment is used as specified in applicable national regulations.

When moving the appliance, ensure the following personal protective equipment is used:

- Protective gloves
- Safety boots
- Hard hat (e.g. when heavy loads are being lifted working overhead)

General precautions

- The kitchen floor must always be kept dry to reduce the risk of accidents
- The appliance door of the microwave combination oven must be closed before disposing of the appliance
- Do not leave food in the cavity

Potential risks

Risk of electric shock from live parts and loose cables



When the safety cover is open, there is a risk of electric shock from touching live parts. Make sure that any work on the electrical system is performed solely by a qualified electrician from an authorized service company.

Risk of injury from lifting incorrectly



Risks associated with lifting incorrectly and how to avoid injuries are detailed in *Section 1F: Hazard and Safety Precautions during installation and setting up*.

Risk of crushing if the appliance tips over or falls off



See *Section 1F: Hazard and safety precautions during installation and setting up* for details on minimizing risks associated with the appliance tipping over.





Section 2: Operations and Installation



2A. Introduction to e1s

The Merrychef eikon e1s microwave combination oven offers you the flexibility of combination cooking with additional control over fan speed and microwave power.

Combination cooking enables high quality results to be achieved in a fraction of the time taken by conventional cooking, particularly when baking, browning, roasting and grilling dishes.

Once established, precise instructions for combination or convection cooking of selected items may be programmed into the oven's memory so that they can be repeated easily and accurately. Up to 1024 programmes can be stored and simply recalled.

The oven controls offer even greater flexibility by allowing multistage programming. This enables the exact conditions required for quality results to be set according to the food type. A single cooking programme can have up to six stages, each stage controlled with its own time, fan speed and microwave power settings.



Figure 2.1: e1s oven front view

Identifying your microwave combination oven

A nameplate is located on the rear of the microwave combination oven and contains information on the make, model, serial number, regulations, electricity and power supply and the manufacturing site.

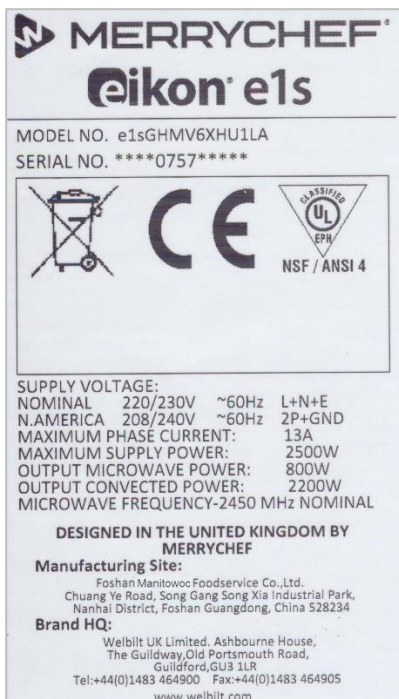

Figure 2.2: e1s name plate



See Section 1B for more details on the information included on the nameplate.

Appliance parts and their functions

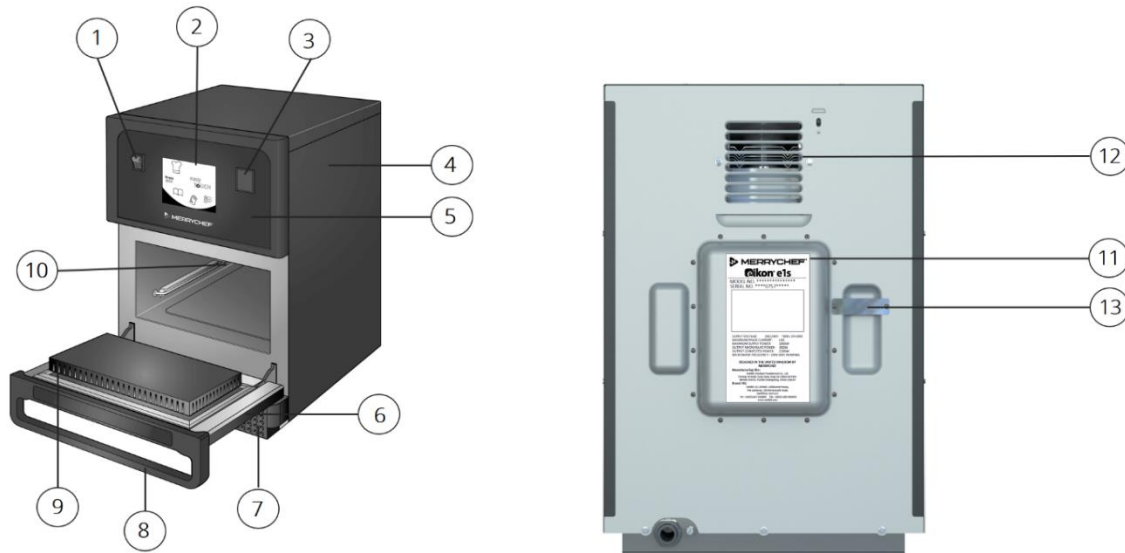

Figure 2.3: Appliance parts and their functions

- 1) **ON/OFF appliance switch** – Used to turn the microwave combination oven on and off. Turning this switch off does not isolate the appliance from the electricity supply.
- 2) **easyTouch® screen control panel** – When the appliance is switched on, the easyTouch® screen illuminates the user interface.
- 3) **USB port** – A USB socket located under the cover allows updates to programmes stored on the appliance.
- 4) **Protective cover** – The cover can only be removed with specific tools. It prevents live parts from being touched accidentally and prevents access to the moving fan. Always ensure the cover is securely in place.
- 5) **Operating panel** – Prevents live parts from being touched accidentally. Always ensure the panel is in place.
- 6) **Appliance door** – This is a precision-made energy barrier with three microwave safety interlocks. Always keep it clean and do not use it to support heavy objects.
- 7) **Air filter** – Situated at the lower front of the appliance, the air filter is part of the ventilation system. Keep it free of obstruction and clean it daily as described under *Section 2G: Cleaning procedures*.
- 8) **Door handle** – A rigid bar which is pulled downwards and away from the appliance to open it.
- 9) **Door seals** – Ensure a tight seal around the door. Always keep them clean and check regularly for signs of damage.
- 10) **Cavity** – Also known as the cooking chamber, the cavity is constructed from stainless steel and used for cooking products.
- 11) **Nameplate** – A plate on the rear of the oven that states the serial number, model type and electrical specifications.
- 12) **Air outlets** – On the rear and are used to cool internal components and allow steam from the cavity to escape. The air outlets must be kept free from obstruction and they will not allow microwave energy to escape into the environment.
- 13) **Steam pipe and cover** – A covered pipe from the cavity to the back of the oven to vent steam during cooking and prevent pressure build up.



Equipment and accessories supplied

The e1s microwave combination oven is supplied with the following equipment and accessories.



Cook plate

The cook plate sits inside the appliance and food is placed on top of it using suitable liners or baskets. It is removable for cleaning.

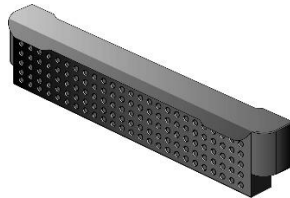

Air filter

The air filter situated at the lower front of the appliance is part of the ventilation system and should be kept clean and free of obstruction.

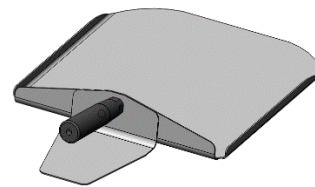

Paddle

The paddle is used to remove food from the oven.



There are a number of other optional Merrychef accessories that customers can purchase to use with the microwave combination oven. Contact Merrychef suppliers for more information.



2B. Installing the appliance



Users must read *Sections 1A to 1K (Safety Guide)* before installing or using the microwave oven.

Unpacking

1. Cut the box banding straps and remove the lid.

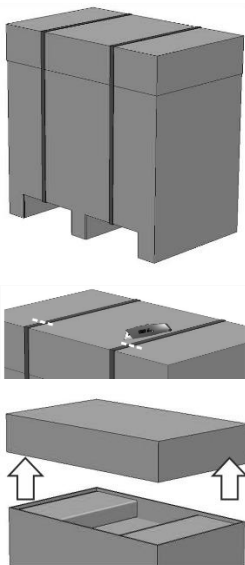

2. Remove the customer documentation and any product accessories:

- 1x air filter
- 1x cook plate
- 1x Operations and Installation Guide

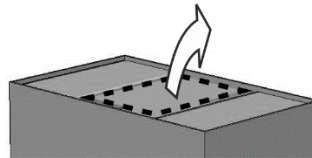

3. Remove the packaging to reveal your microwave combination oven.

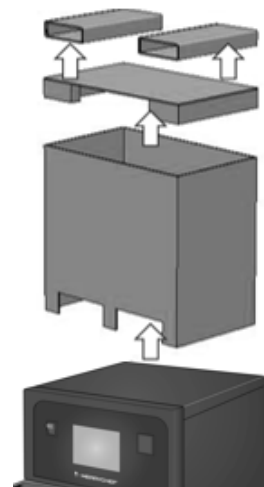

Inspect the appliance for damage before signing the delivery note. Record any damage on the delivery note and notify the carrier and manufacturer.



WARNING Never install or put into service a damaged appliance under any circumstances.

Taking the appliance off the pallet

1. Identify appropriate lifting points.



- Wear appropriate Personal Protective Equipment.
- **Do not lift the oven by the handle.**
- Risk of crushing from the appliance tipping over. Take precautions.

2. Lift the appliance from the packaging. The appliance is now ready for installation.

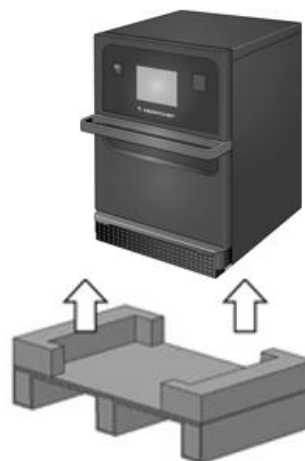

Installation location requirements

Minimum space required

Figure 2.4 shows the space required to install the appliance. It also shows the minimum horizontal distances from adjacent walls and surfaces. The safety clearance on the top must also always be complied with.

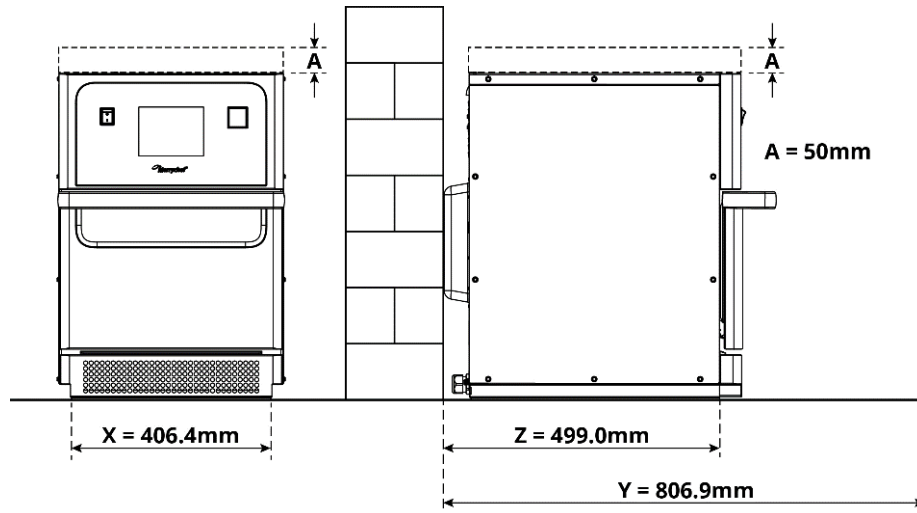

Figure 2.4: Minimum space requirements

- Safety clearance from the top (A) = 50mm (2")
- Depth requirement:
 - Width of appliance (X) = 406.4mm (16")
 - Total depth with door open (Y) = 806.9mm (31.8")
 - Counter depth (Z) = 499.0mm (19.6")
- Safety clearance on left-/right-hand side / at rear: 0mm

Actual space requirements

Far more room than the specified minimum space requirement is needed in front of the appliances to operate the microwave combination ovens safely, in particular to handle hot food safely. Larger wall gaps are generally recommended to provide access for servicing.

In the installation location, the following parts must not be covered, adjusted or blocked:

- Air vent on the rear of the appliance
- Air filter at the front of the appliance

Mounting the appliance on a work surface

The appliance can be mounted on a suitable work surface that can bear the weight.

Observe the following rules to ensure that the appliance is installed in a stable situation:

- The worktop must have a non-slip surface.
- The supporting surface must have the following properties:
 - The supporting surface must be flat and level.
 - The supporting surface must be able to bear the in-use weight of the appliance, plus the weight of the structure supporting the appliance as follows: 50Hz = 46kg / 101lbs and 60Hz = 45kg / 99lbs.

Electrical installation requirements

Safety rules

⚠ DANGER

Observe the following rules to prevent hazards caused by faulty electrical connections:

- Only electricians qualified under the terms of EN 50110-1 and from an authorised service company are permitted to perform work on electrical equipment.
- The electrical supply must be connected in accordance with applicable local regulations of the professional associations and of the relevant power supply company.
- The case of the appliance must be grounded in a suitable manner and connected to an equipotential bonding system.
- If two microwave combination ovens are installed in a stacking kit, both cases of the appliances and the stacking kit itself must be grounded in a suitable manner and connected to an equipotential bonding system.
- Wear the personal protective equipment as specified in the *Section 1F*.

Grounding instructions



The appliance must be grounded. Connect only to a properly grounded outlet. See 'Grounding instructions' in Section 1F.

Equipment provided by customer and electrical installation regulations

Table 2.1 shows what equipment must be provided by the customer and what regulations must be observed when connecting the appliance.

Equipment	Regulations
Fuse	Fuse protection and connection of the appliance must comply with local regulations and national installation requirements.
Equipotential bonding	The appliance must be incorporated in an equipotential bonding system. Equipotential bonding: electrical connection that ensures that the frames of electrical equipment and any external conductive components are at an equal (or practically equal) potential.
Residual-current device (RCD)	The installation regulations require protection by a residual-current device (RCD). Suitable residual-current devices meeting the relevant national regulations must be used. If the installation includes more than one appliance, one residual-current device must be provided for each appliance.
Disconnection device	An easily accessible all-pole disconnection device with a minimum contact separation of 3mm must be installed close to the appliance. The appliance must be connected via this disconnection device. The disconnection device is used to disconnect the appliance from the electrical supply for cleaning, repair and installation work.

Table 2.1: Electrical equipment and regulations

The requirements and specifications for e1s

Fitted frequency converter

- The appliance is fitted with one frequency converter (FC) and an EMC mains input filter.
- These devices may result in a leakage current of more than 3.5mA per FC drive.
- Use a suitable RCD for the rated voltage.



Properties of the residual-current device

The residual-current device (RCD) must have the following properties:

- Filter for filtering out RF currents.
- 'Time delayed' trip characteristic for RCD devices with trip threshold >30mA: prevents RCD being tripped by charging currents of capacitors and parasitic capacitances when appliance is switched on.
- 'Leakage current protection, Type SI' trip characteristic for RCD devices with trip threshold >30mA: insensitive to nuisance tripping.

Circuit Breakers

- Establishments with standard (Type 'B') circuit breakers are sensitive to 'surges' which occur on switching on freezers, refrigerators and other catering equipment, including microwave combination ovens. Because of this, a Type 'D' circuit breaker (designed specifically for this type of equipment) must be fitted. An individual, suitably rated circuit breaker should be fitted for each appliance installed.

Low impedance electrical supply

- This commercial combination microwave oven complies with EN 61000-3-11. However, when connecting sensitive equipment to the same supply as the appliance, the user should determine in consultation with the supply authority, if necessary, that a low impedance supply is used.

Electrical supply

- The e1s microwave combination oven is only available as a single-phase model and is designed to draw 13 amps maximum in all configurations, as shown in Table 2.2.

Illustration	Meaning
<p>UK / EU</p>	<p>Phase: Single</p> <p>16 A Breaker for 15/16 A plug configurations and be Time Delay, Motor Start Type (European Type D).</p> <p>UK 13 A models are fitted with a moulded plug to BS1363, fused at 13A. EU13 A models are fitted with a moulded plug to CEE 7/7 (Type F Schuko) rated at 16 A.</p> <p>ROW 13 A models are fitted with country specific 15/16 A plugs.</p> <p>Please contact your local Welbilt representative for further information.</p>
<p>Latin / South America</p>	
<p>China</p>	

Table 2.2: e1s electrical specifications

Equipotential bonding

- An equipotential bonding point is provided on the rear panel of the appliance for independent Earth (GND) connection.



2C. Getting started



Before turning on the oven, users must read *Section 1G: Hazards and safety precautions when preparing appliance for use.*

Fitting the air filter

The air filter is fitted in position below the cavity door. It is a magnetic attachment.

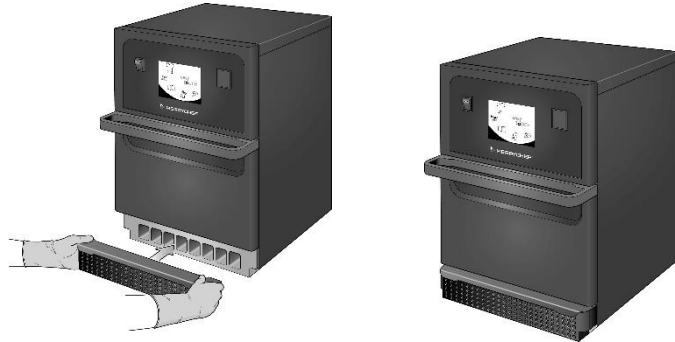

Inserting the cook plate

The cook plate is inserted in the cavity, simply by sliding it onto the shelf runners.

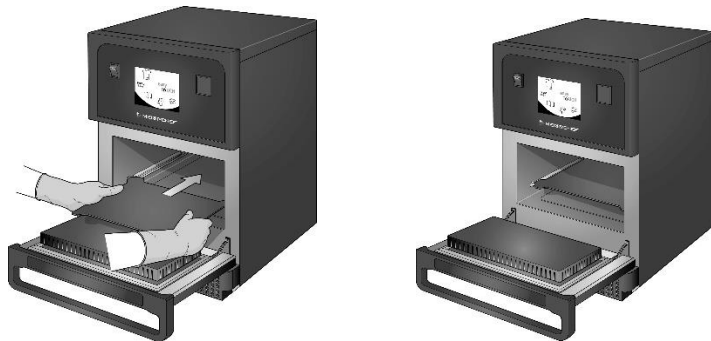

Turning the oven on and off

To start up the oven, ensure the appliance is clean and empty with just the cook plate inside it. Then switch the appliance on using the on/off switch at the front of the oven.

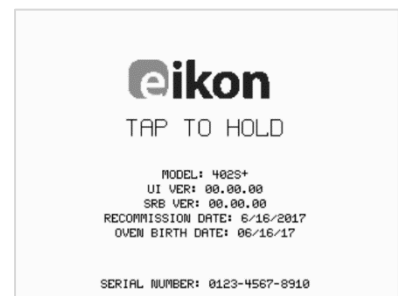

When the oven is switched on, the easyTouch[®] screen illuminates with the display briefly showing the serial number and appliance data. To keep the data on the screen, lightly tap the screen to freeze the display. Tap again to continue.



Settings on first usage

The system is preconfigured with all the required settings to start cooking immediately following installation. However, you may want to configure the following before using the oven.

- Date and time
- Alarms
- Temperature
- Oven time

Settings are changed by selecting the 'settings' screen which is accessible from the main menu.

However, the main menu is only displayed after the oven is pre-heated and therefore, if you want to change settings before or whilst the oven is heating, for example before first usage, do as follows:

- 1) Tap to hold the first screen upon switching on, which shows the serial number.
- 2) Press the hidden button at the top right-hand corner to load the password screen.

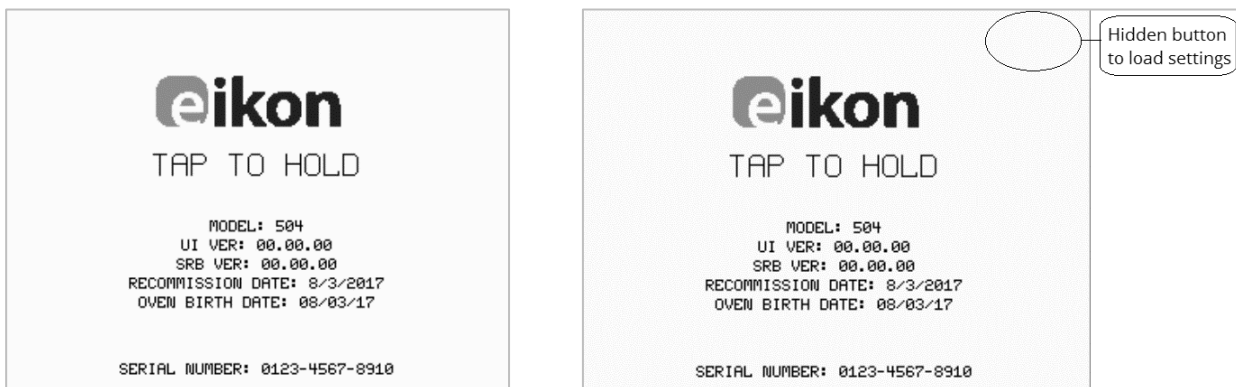

- 3) Enter the administration password. The default password is 'MANAGER'.
- 4) Select the required settings icon to make changes as required.

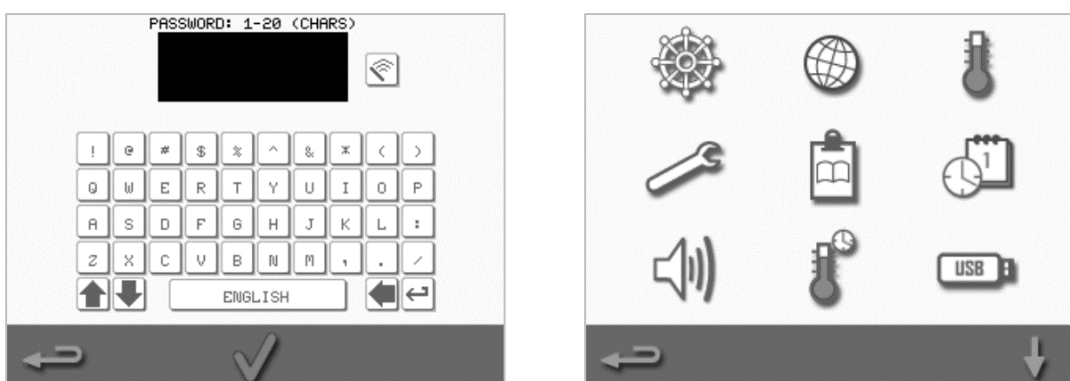

See *Section 2F: Changing settings* for instructions.



Selecting suitable utensils

You may want to ensure you have suitable utensils before using the oven. Only use utensils that are suitable for use in microwave combination ovens. Check the manufacturer's instructions and temperature rating to determine the suitability of individual containers or utensils.

Table 2.3 provides general guidelines:

Cooking utensils	Permitted	Notice
Heat resistant containers		
Toughened glass	YES	
Compatible vitreous ceramics	YES	Do not use items with metallic decoration
Earthenware (porcelain, crockery and china)	YES	
Metals, foils and plastics		
Metallic and foil trays and containers	NO	
Dual-ovenable plastic containers	YES	Use only containers approved by the manufacturer
Disposables		
Combustibles (paper, card, etc.)	YES	Use only combustibles approved by the manufacturer
Other utensils		
Tie tags	NO	
Cutlery	NO	Do not leave utensils in a food product while it is cooking
Temperature probes	NO	

Table 2.3: Suitable utensils

Preheating the oven

The oven will automatically preheat to the set temperature when it is switched on. However, if the appliance is set up with two or more preheating temperatures, a choice is displayed when the oven is switched on. Select the required temperature.



You may see a scroll arrow at the bottom of the screen which indicates that there are more temperature choices.

During preheating, the display shows the progress as the cavity heats up to the set temperature. To stop the cavity heating up, touch the red 'X' symbol at the bottom of the screen.

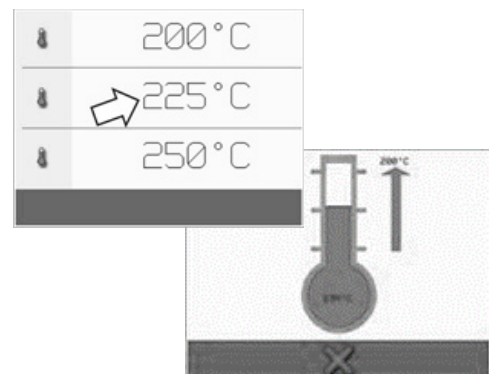

The appliance is ready to use when either the cookbook or main menu is displayed.

If the cookbook is displayed, press the Backspace button in the bottom left-hand corner of the screen to display the main menu.

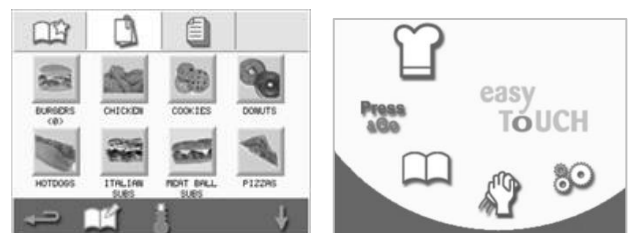

Understanding the main menu and keyboard



Main menu



Keyboard



The easyTouch® screen display, layout and icons shown herein are for guidance purposes only and are not intended to be an exact representation of those supplied with the appliance.

Button	Meaning	Function
Main menu		
	Development Mode	'Development Mode' enables multistage cooking profiles to be developed, then stored under a name and symbol for reuse.
	Press&Go	'Press&Go' allows quick access to use the cooking profiles that are already stored.
	Cookbook	'Cookbook' contains the cooking profiles stored in the memory of the appliance.
	Cleaning / Temp change	'Cleaning / Temp change' allows the cavity temperature to be changed and the appliance to be prepared for cleaning.
	Settings	'Settings' are used to control the appliance settings and functions and for service and maintenance purposes.
Keyboard		
	Keyboard screen	The 'keyboard screen' is used to enter password and to insert data for programmes.
	Clear screen	Select the 'clear screen' key to delete text from the keyboard screen.
	Keyboard	Use the 'keyboard' to type in text.
	Spacebar	Select the 'spacebar' key to insert a blank.
	Return	Select the 'return' key to start a new line.
	Keyboard scroll	Select the up/down arrows to scroll the keyboard screen.
	Enter / OK	Select the green tick to confirm settings and continue.
	Previous screen	Select the 'backspace' key to return to a previous screen.

Table 2.4: Main menu and keyboard items







Character length

- Use 1-20 characters in two lines max for names of cooking profiles, cooking profile groups and passwords.
- Use 1-54 characters in five lines max for stage instructions of individual cooking profiles.

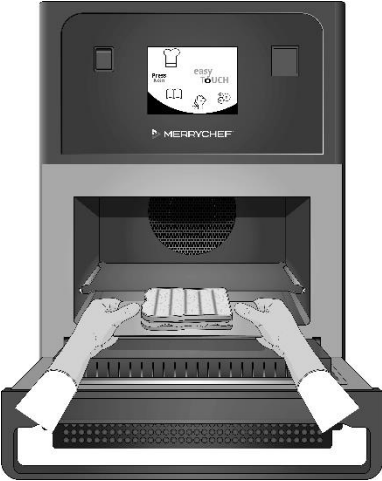

2D. Cooking procedures

How to cook

 <p>1. On a preheated oven, select a cooking profile from the cookbook or enter a new cooking profile. <i>See Section 2E for instructions on how to enter a new cooking profile.</i></p>	 <p>2. Open the appliance door and place the prepared food on the cook plate. ⚠ WARNING Hot surface <i>Ensure all packaging has been removed.</i></p>	 <p>3. Close the appliance door again. <i>The cooking process will automatically start if the programme was selected in step 1. Alternatively, the programme can be selected or changed at this stage.</i></p>
 <p>4. Wait for the cooking process to finish. An audible signal is given when the cooking process is finished. Follow the prompts displayed by the software. <i>Do not open the oven door while the food is cooking.</i></p>	 <p>5. Open the appliance door and take the food out. ⚠ WARNING Hot surface <i>Do not remove cook plate unless cleaning.</i> <i>Never leave food in the oven, as it will continue cooking.</i></p>	 <p>6. Close the appliance door again after taking the food out. <i>The cooking programme is reset now and a new cooking profile can be selected to use the oven again.</i></p>



Using a cooking profile – quick serve mode

1. Select the 'cookbook' symbol  from the main menu screen and then select the All Menus option.



2. Use the scroll up/down arrows to find the cooking profile.

Note: If a picture has a red frame around it, this means the cavity temperature is set too high or too low for that cooking profile. The cavity temperature will need to be changed to use that option. See Changing cavity temperature.



3. Select the required cooking profile to start cooking. For example: 'ITALIAN SUB x 1'.



4. Follow any instructions on the screen, if displayed, and press the green tick to start the cooking process.

Note: If food has not been placed in the oven, at this stage open the oven door and place it on the cook plate and then press the green tick.

⚠WARNING Hot surfaces at the door and in the cavity.



5. The cooking time counts down for each stage. When the cooking profile ends, a red bar is displayed usually with an audible sound. Open the door or touch the red 'X' to return to the cooking profile.

Note:

- Opening the appliance door during cooking stops the cooking profile and displays a warning. Avoid opening the door during the cooking process.
- Closing the door, however, allows the user to continue or cancel the cooking profile.



Using a cooking profile – full serve mode

1. Select the 'cookbook' symbol  from the main menu screen and then select a group of cooking profiles, for example 'ITALIAN SUBS', to display the individual cooking profiles.

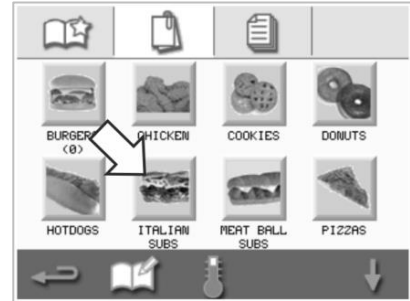

2. Select a cooking profile from the options available in the selected group, for example 'ITALIAN SUB x 2'.



3. Follow any instructions on the screen, if displayed. Press the green tick to start the cooking process.

Note: If the product has not been placed in the oven, at this stage open the oven door and place the food on the cook plate and then press the green tick to start cooking.

⚠WARNING Hot surfaces at the door and in the cavity.



4. The cooking time counts down for each programme stage. When the cooking profile ends, a red bar is displayed usually with an audible sound. Open the door or touch the red 'X' to return to the cooking profile.

⚠WARNING Hot surfaces at the door and in the cavity.

Note:

- To check the cavity temperature when cooking, lightly tap the temperature displayed. The cavity temperature is shown with an asterisk.
- Opening the appliance door during cooking stops the cooking profile and displays a warning. Avoid opening the door during the cooking process.
- Closing the door, however, allows the user to continue or cancel the cooking profile.

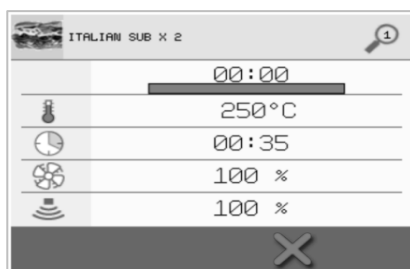
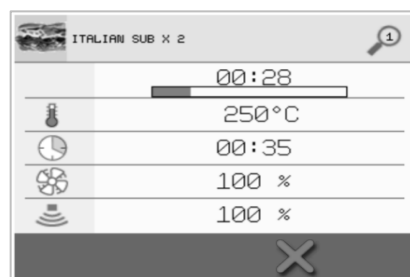

Choosing cooking profiles for Press&Go menu

1. Select 'Press&Go'  from the main menu screen, and then select the 'edit cookbook' symbol.

Two lists are displayed.

- The list on the left shows the cooking profiles that are part of the 'Press&Go' menu.
- The list on the right shows other cooking profiles that are available.

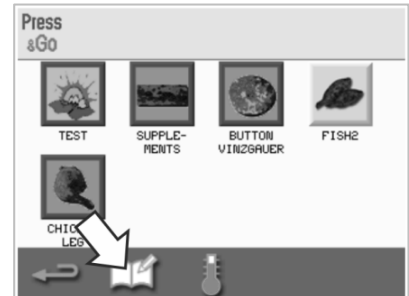

Both lists can be scrolled up or down using the blue arrows on the right of each list.

2. Select a cooking profile from the list on the left.
 - Choose whether to change its position within the list or to remove it into the list on the right.
 - To change the order of cooking profiles in the left list, use the blue up/down arrows in the middle.
 - To move a selected cooking profile to or from the 'Press&Go' menu, use the green/red arrows in the middle.
 - To make a cooking profile from the right list available in the 'Press&Go' menu, move it into the left list.

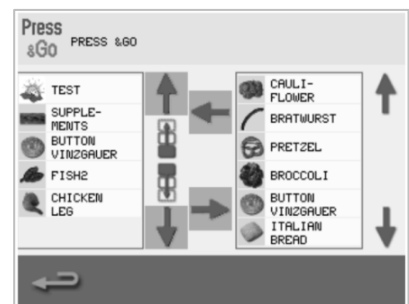

3. Select backspace to return to the 'Press&Go' menu screen when finished.

Running a cooking profile from the Press&Go menu

4. Select 'Press&Go'  from the main menu screen and then select the cooking profile required to cook.

Note: Follow any instructions on the screen, if displayed. If the product has not been placed in the oven, at this stage open the oven door and place the food on the cook plate and then press the green tick to start cooking.



5. The display shows the cooking time countdown. The timer bar turns red to indicate that the cooking cycle has finished.



Changing the cavity temperature

You may need to change the cavity temperature depending on the food you are cooking. If the cavity temperature is set to a value unsuitable for a cooking profile, it will need to be changed before that cooking profile can be used. Cooking profiles unsuitable for the set temperature are highlighted with a red border.

To change the cavity temperature:

1. Take note of the cavity temperature required for the cooking profile and then press the green tick to continue.

Note: You can find out the required temperature by selecting a cooking profile highlighted with red border.



2. Select the 'temperature' symbol in the selected cooking profile screen.

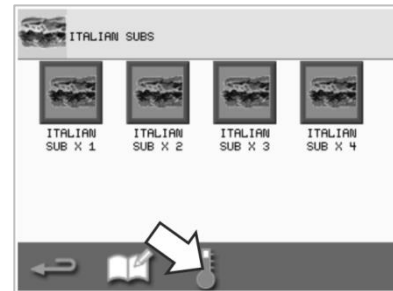

3. An asterisk next to the temperature value indicates the present cavity temperature. Select the required cavity temperature for the cooking profile.



2E. Cooking profiles

Creating a cooking profile

1. Enter development mode

Select the 'chef's hat' symbol from the main menu screen to enter development mode.



2. Set the microwave power

The temperature value displays the set preheating temperature. To change the temperature, select the 'temperature' symbol, and enter a value within the limits displayed.

Select the green tick to continue.

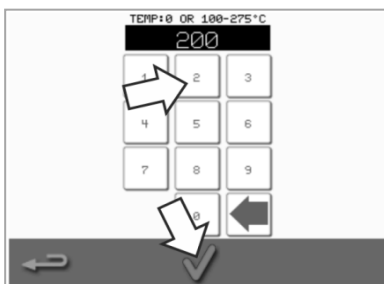
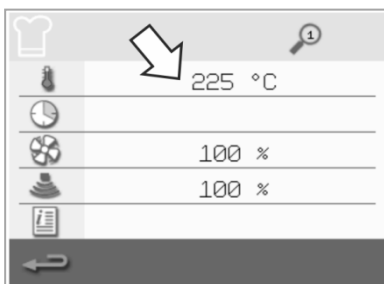

3. Set the cooking time

Select the 'clock' symbol and enter the cooking time for each stage up to a maximum of 10 minutes.

Example: Enter 110 = 1 minute and 10 seconds.

Select the green tick to save the inserted value.

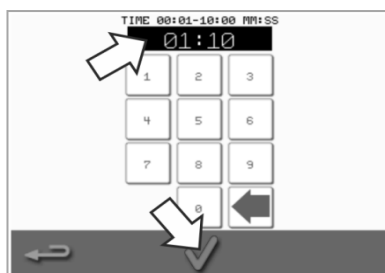
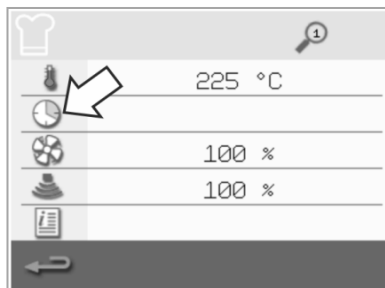

4. Set the microwave power

Select the 'microwave' symbol and set the microwave power (0 and 5-100%).

Select the green tick to save the inserted value.

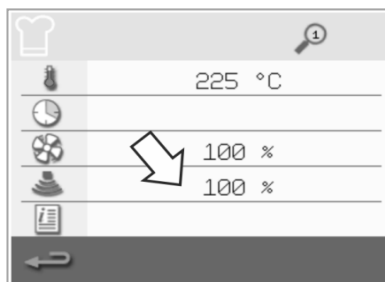

5. Set the fan speed

Select the 'fan' symbol and set the fan speed within the limits shown on the screen.

Select the green tick to save the inserted value.

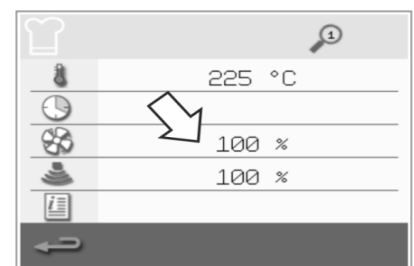

6. Enter instruction for a stage (optional)

Select the 'information' symbol to enter instruction for a stage.

Example: 'Stage 1 - place a food product into the cavity'.

Select the green tick to save the inserted instruction.

Select the right arrow with a 'plus' symbol at the bottom to add a new stage by repeating the steps above.

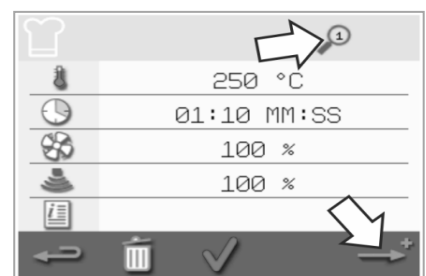

Note:

- Cooking profiles can have up to a maximum of six stages.
- The 'magnifier' symbol at the top indicates which stage is displayed.
- Select the left/right arrow at the bottom to shift between the stages.

Viewing and editing cooking profiles

1. Select the 'cookbook' symbol from the main menu screen.



2. Select the 'All menus' symbol from the cookbook screen.

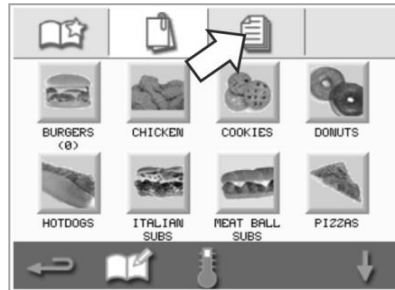

3. Select the 'edit cookbook' symbol.

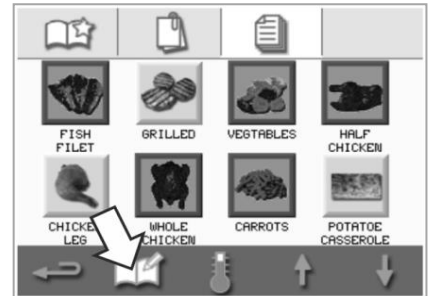

4. Use the up/down scroll arrows to find the cooking profile.

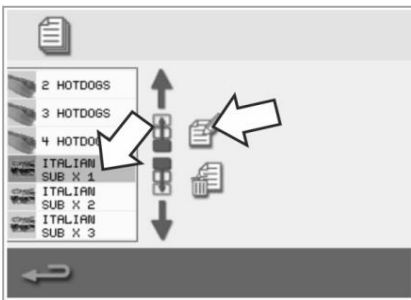

5. Select the 'view/edit cooking profile' symbol.

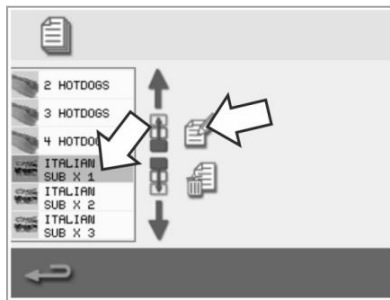

6. View or adjust the cooking profile as required.

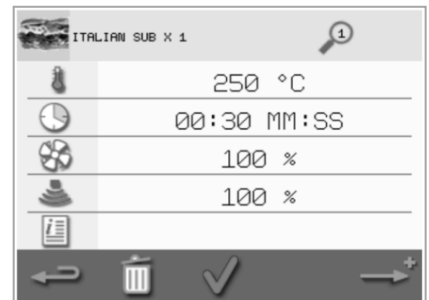

See *Creating Cooking Profile* for instructions on how to change cooking profile entries.

Moving a cooking profile in a group of cooking profiles

1. Select the 'cookbook' symbol from the main menu and select the group of cooking profile to move, e.g. 'ITALIAN SUBS'.

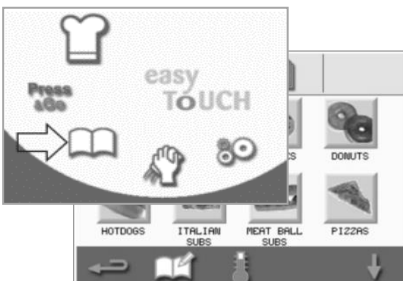

2. Select the 'edit cookbook' symbol in the selected cooking profile screen.

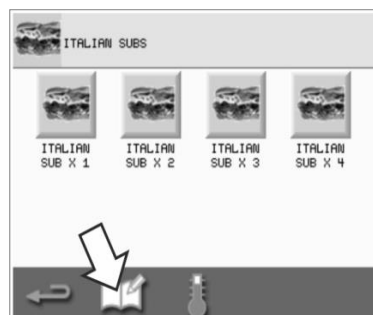

3. Select the cooking profile to move and use the smaller up/down arrows to move it within the group.

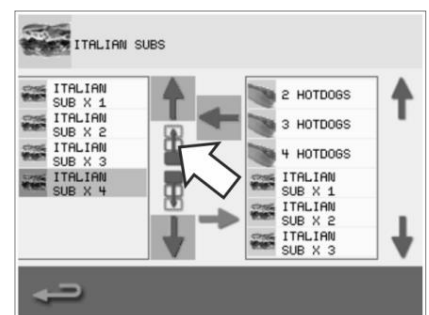

Moving a cooking profile in a list

1. Select the 'cookbook' symbol from the main menu screen and then select the 'edit cookbook' symbol in the cookbook screen.

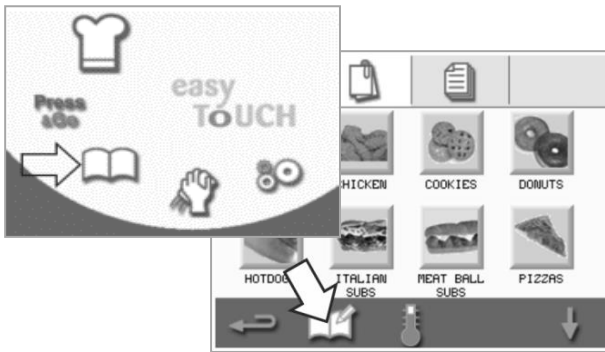

2. Use the big scroll arrows to locate cooking profile groups and then use the small arrows in the centre of the screen to move the selected cooking profile within the list. Use backspace to return to the cookbook screen.

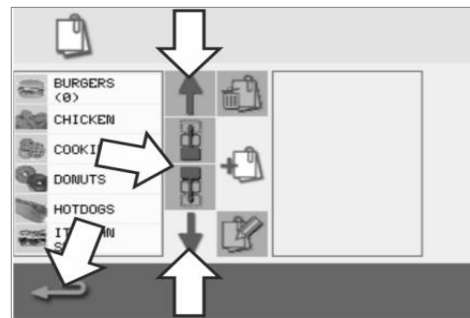

Adding a new cooking profile group

1. Select 'cookbook' from the main menu screen.
2. Select the 'edit cookbook' symbol from the cookbook screen.
3. Select the 'add a new cooking profile group' symbol.

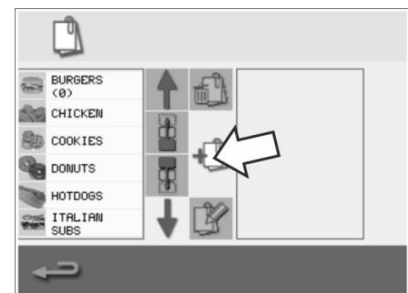
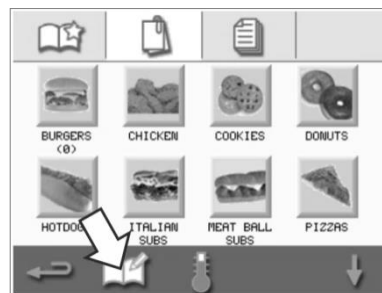

4. Select the 'camera' symbol to open a database of pictures.
5. Select a picture for the cooking profile group. You can use the scroll arrows at the bottom of the screen for more pictures.
6. Enter a name for the new cooking profile group (max. 20 characters) and press the green tick to save it.

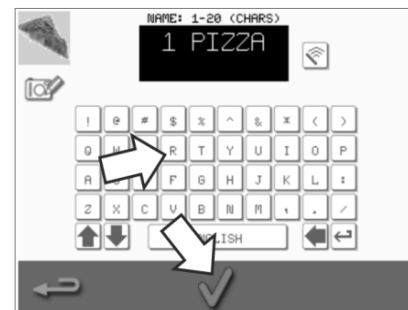
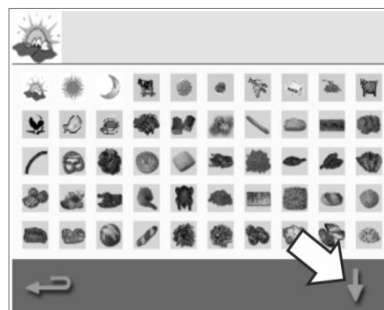
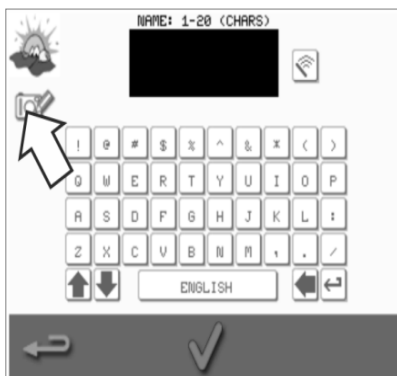

Adding a cooking profile to a group of cooking profiles

1. Select 'cookbook' from the main menu screen.
2. Select the cooking profile group you want to add to.
3. Select the 'edit cookbook' symbol in the cooking profile screen.

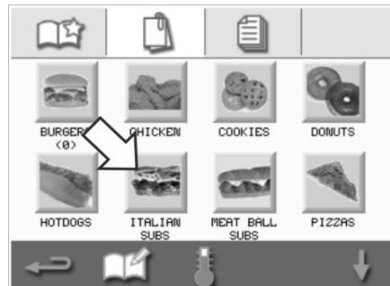

4. Use the up/down scroll arrows on the right to find and select the cooking profile you want to add.
5. Select the green 'left' arrow to add the selected cooking profile, which will now be listed on the left.

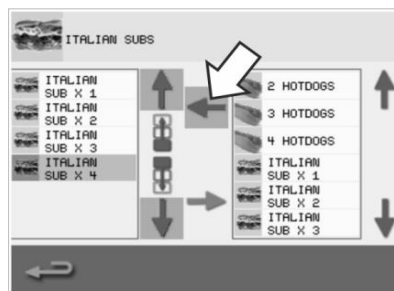
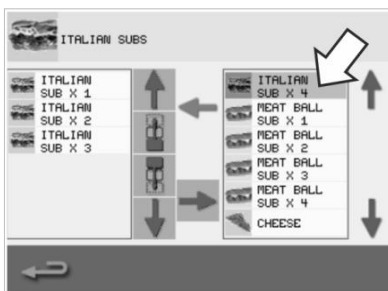

Deleting a cooking profile group

1. Select 'cookbook' from the main menu screen.
2. Select the cooking profile group to delete.
3. Select the 'edit cookbook' symbol.

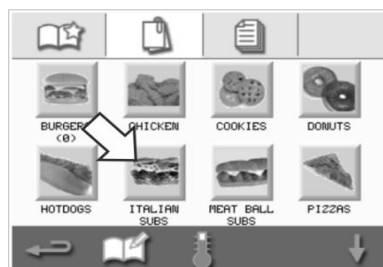
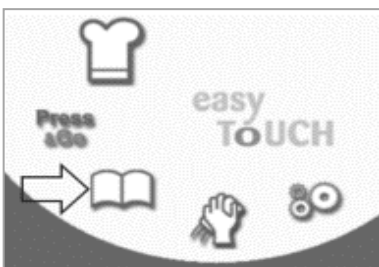

4. Select the 'delete cooking profile group' symbol.
5. Select the green tick to delete the cooking profile group.

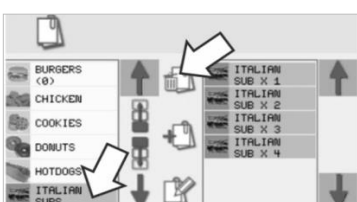

Editing a selected cooking profile group name

1. Select 'cookbook' from the main menu screen.



2. Select the 'edit cookbook' symbol from the cookbook screen.

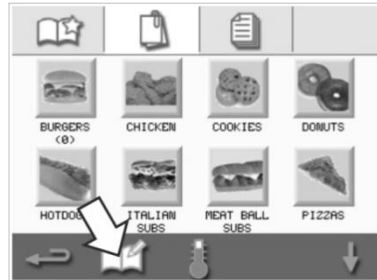

3. Select the cooking profile group that you want to edit.

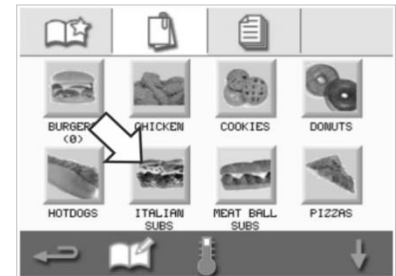

4. Select the 'edit cooking profile group' symbol.

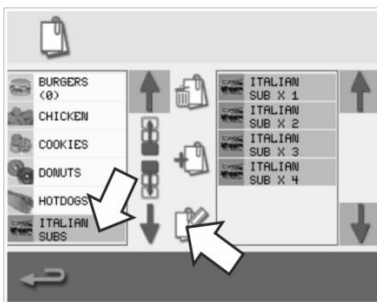

5. Enter the new name of the cooking profile group and select the green tick to continue.

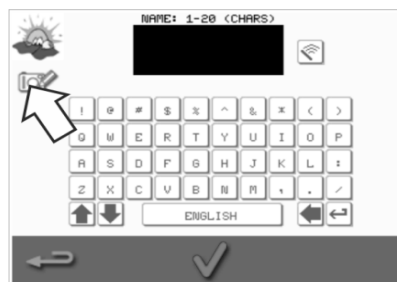

2F. Changing settings

Changing settings process

1. Select the 'settings'  symbol from the main menu screen.

Note: The main menu is displayed after the oven is pre-heated. If you want to change settings without pre-heating the oven, for example change settings before first usage, you should tap the first screen to hold it and then press the hidden key at the top right-hand corner to load the password screen, shown in step 2.

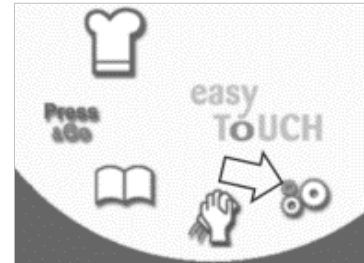

2. Enter your password and select the green tick to display the 'settings' options.



3. Make changes as required. Use the up/down scroll arrows at the bottom of the screen to display all functions of the 'settings' menu.

The 'settings' menu comprises the following functions:

- A. Operating mode / navigation settings
- B. Language options
- C. Cavity temperature settings and labels
- D. Service information and error logs
- E. Cooking profile counters
- F. Date and time settings
- G. Speaker and sound level settings
- H. Timer (Temperature / ON / OFF)
- J. USB programme downloads
- K. Temperature band settings
- L. Change settings / service access passwords
- M. Screen saver

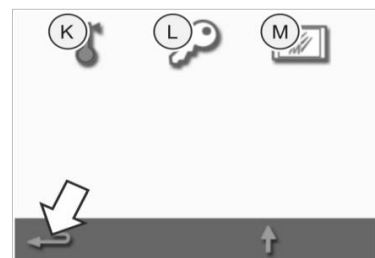
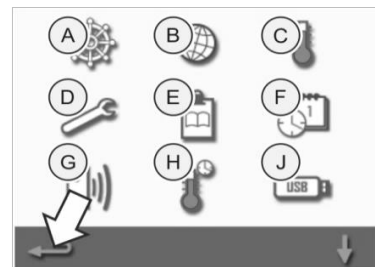

When finished with a setting, select backspace to return to the main settings menu to make other changes.

4. Press the backspace button to exit the 'settings' menu. A prompt appears to either 'SAVE' or 'DISCARD' any changed settings.



Operating mode / navigation settings

1. Select the 'operating mode/navigation' symbol from the settings menu.

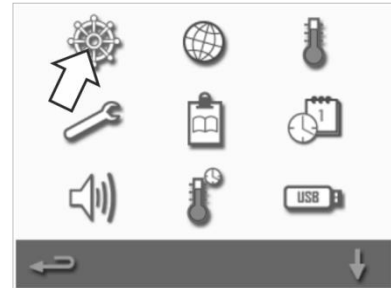

2. Select 'QUICK SERVE MODE' for cooking only.
Select 'FULL SERVE MODE' for creating cooking profiles.
Select 'MANUAL MODE' to manually cook only via the 'chef's hat' symbol on the main menu screen.
Select 'ENABLE SETTINGS' to display an 'unlock' symbol on the 'Quick Serve Mode' screen to allow access to the 'settings' menu.

Note: If a green tick is displayed, the corresponding function is active.

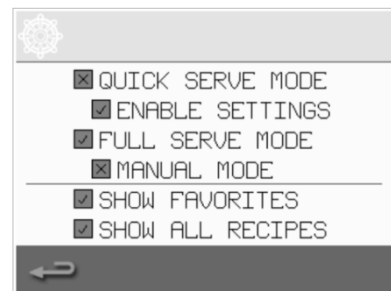

3. Select 'MAGNETRON ENERGY DELAY' to enable a magnetron warm up period for all cooking profiles.

Select 'ENERGY SAVING' to enable the hibernation mode when the oven is inactive.

Language settings

1. Select the 'globe' symbol from the settings menu



2. Select the checkbox(es) of the required language(s) from the list shown.



Cavity temperature settings and labels

1. Select the 'temperature' symbol from the settings menu.

The temperature screen is displayed if two or more cavity temperatures are set above the minimum. You can now:

- A) Change a temperature set
- B) Edit the existing temperature labels
- C) Add a new temperature
- D) Change the measurement unit

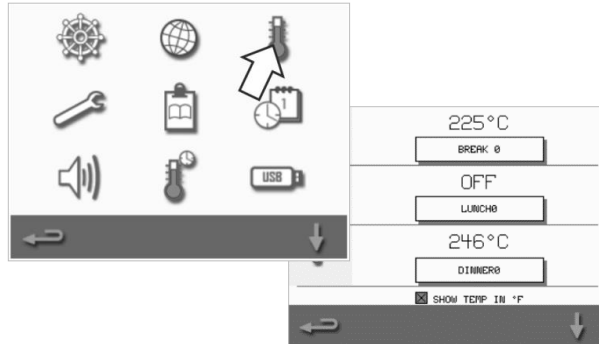

A) Change a temperature set

1. Select the temperature you want to change by tapping the value or the red temperature symbol next to it.
2. Edit the temperature as required using the keypad.
3. Select the tick to continue.

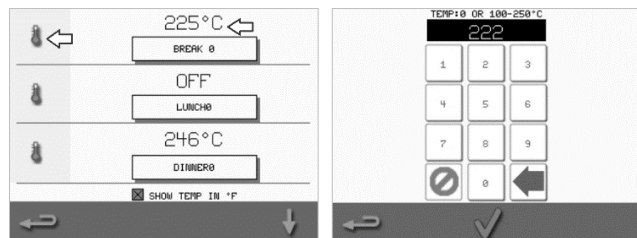

B) Edit temperature labels

1. Select the required label below the temperature.
2. Edit the label as required using the keypad
3. Select the tick to continue.

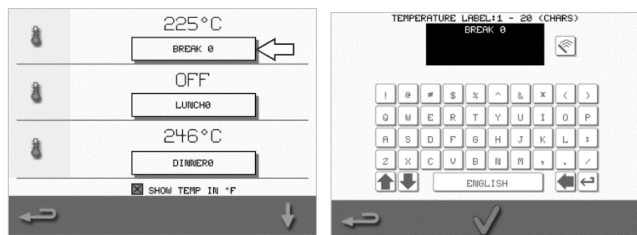

C) Add a new temperature

1. Select a disabled temperature option from the screen (scroll down using arrow if required).
2. Select the temperature area marked as 'disabled' or the red temperature symbol.
3. Enter a temperature value using the keypad and select the tick to continue.
4. Select the 'Optional Label' box to assign a label to the temperature and select the tick to continue.

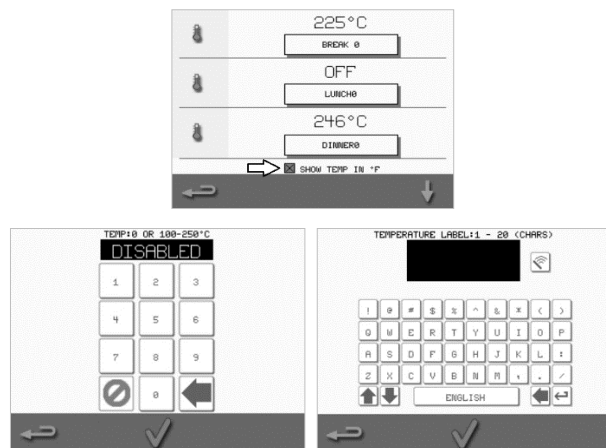

D) Change measurement unit

You can change the temperature measurement unit from Celsius to Fahrenheit and Fahrenheit to Celsius by simply selecting or deselecting the unit checkbox.

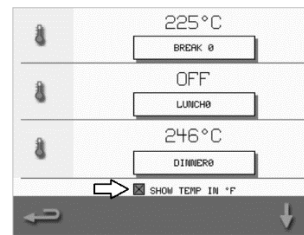

Service information and error logs

The service information and error log function is required for servicing and repairing the system and therefore covered in the *Service and Repair Guide*.



Cooking profile counters

1. Select the 'clipboard' symbol to display a listing of cooking profile counters.



2. The recipe counts are listed on the right of the screen. Use the up/down arrows at the bottom of the screen to scroll to the required recipe.

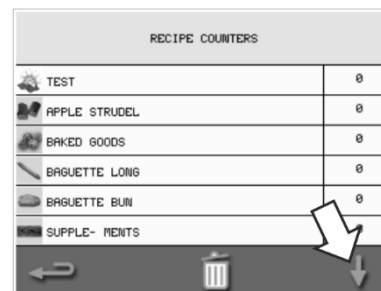

Adding recipes

Recipes can be uploaded from a USB stick. See *USB programme downloads*.

Removing recipes

You can remove a recipe by selecting it and then selecting the bin symbol.



Setting the date and time

1. Select the 'clock/date' symbol from the settings menu to display the setting options.

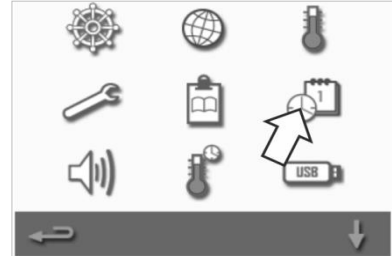

Change the date:

2. Select 'MONTH', enter the correct month on the keypad and select OK.
3. Select 'DAY', enter the correct day on the keypad and select OK.
4. Select 'YEAR', enter the correct last two digits of the year on the keypad and select OK.
To display the month first, followed by the day and year, select the 'MM-DD-YY' checkbox.
A correct date supports servicing as the error logs are recorded using these date settings.

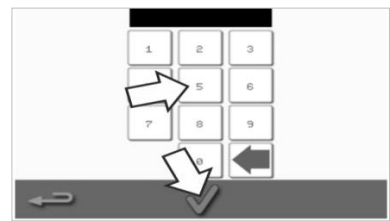
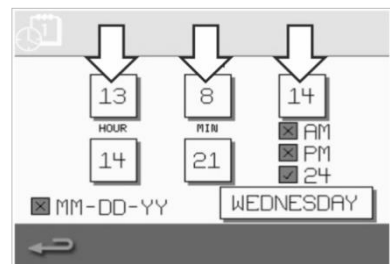

Change the time:

5. Select 'HOUR', enter the correct hour on the keypad and select OK.
6. Select 'MIN', enter the correct minutes on the keypad and select OK.

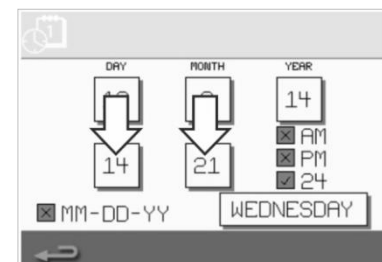

7. Select the day name.

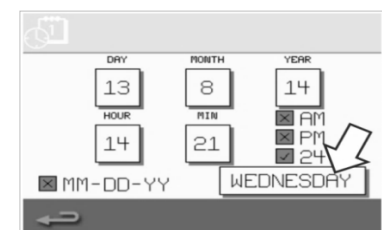

Sound settings

1. Select the 'speaker' symbol to access the volume, tone and further sound settings.

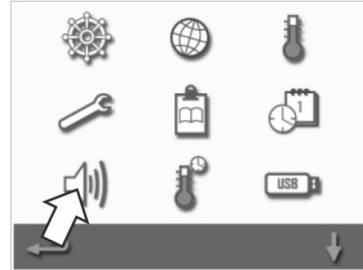

2. Make changes as required:

- a) Select the 'speaker' symbol to adjust the volume level suitable for the environment from none (OFF) to the loudest (100%).
- b) Select the 'music note' symbol to set LOW, MED or HIGH tone.
- c) Select the 'keypad' symbol to switch the sound ON or OFF when the touchscreen is pressed.

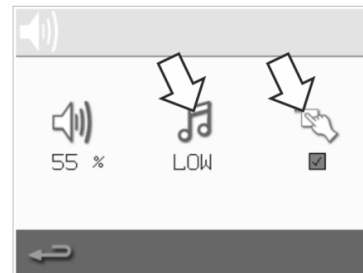

Temperature timer setting

1. Select the 'thermometer / timer' symbol from the settings menu.

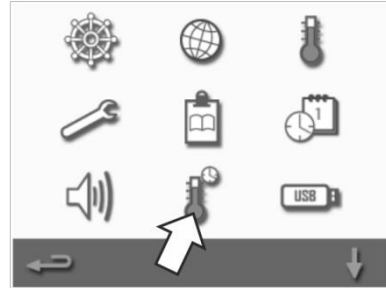

2. Select the 'timer enabled' checkbox (green tick).
3. Select a weekday using the up/down arrows at the bottom of the screen.
4. Select an empty 'time' box (maximum of five per day) or clear an existing 'time' box using the 'wipe' symbol next to it.

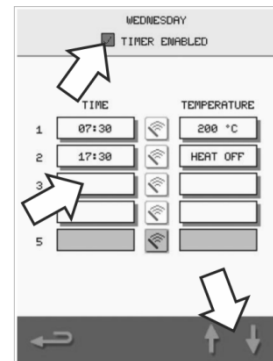

5. Enter the start time on the keypad.
Press the green tick to continue.

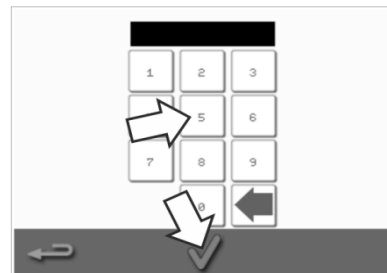

6. Select an empty 'temperature' box opposite the respective 'time' box or clear the required 'temperature' box using the 'wipe' symbol next to it.

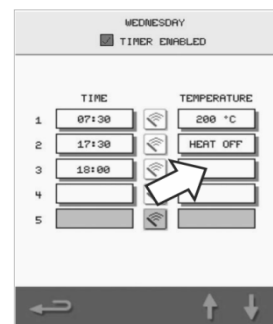

7. Enter the cavity temperature required on the keypad.

Alternatively:

- Select zero to turn the heat OFF.
- Select the red circle symbol to switch OFF the appliance.

Press the green tick to continue.



USB programme downloads

1. Switch the appliance OFF and open the cover to the USB port on the control panel.

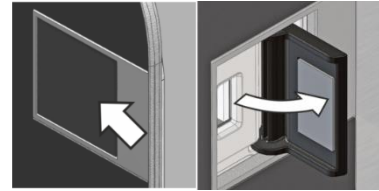

2. Plug in the USB memory stick and switch on the oven.

Note: If the USB memory stick is too large, use a standard commercial adapter cable.

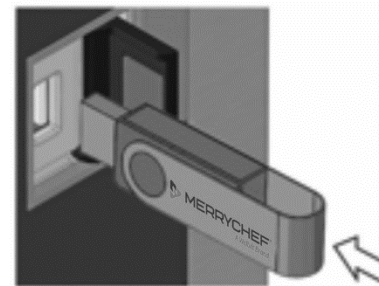

3. Select the 'USB' symbol from the settings menu.

Note: Check that the memory stick has the correct number/code for the programmes you want to load into the memory (one '.cbr' file and 'autoupdate').



4. Select the type of file you are downloading (firmware or recipes). The files will now automatically download from the USB memory stick showing the progress and confirmation screens for the update.



IMPORTANT: Downloading from a USB memory stick will clear all the existing programmes in the memory of the appliance.



The USB cover protects the USB port so that no water vapour can get into the control electronics. During cooking and cleaning, there must not be a USB memory stick inserted and the USB port must be closed by the cover.

Temperature band setting

1. Select the 'temperature band' symbol.

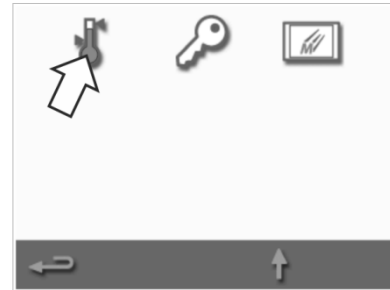

2. Select the required temperature band checkbox, shown by a green tick.

Note: Generally, the lowest practical 'Temp Band' should be chosen. If the set cavity temperature falls by more than the selected temperature band value, the ready-to-cook mode and the temperature band are deactivated until the cavity reaches the preset preheat temperature.

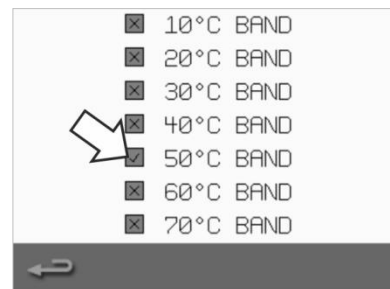

Change setting / service access password

1. Select the 'key' symbol to change the passwords of the appliance.



2. Select the appliance 'settings' or 'service' symbol.

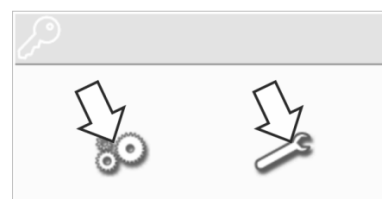

3. Enter the existing password and press the green tick to confirm.
4. Enter a new password and press the green tick.
5. Confirm the new password and press the green tick again.

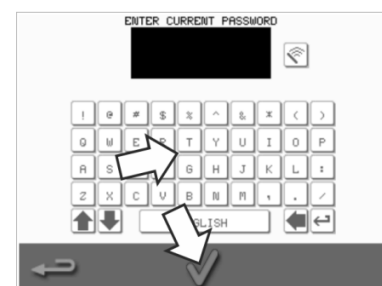

Set screen saver

1. Select the 'ENABLED' checkbox to switch the screen saver ON or OFF and select the 'time' box below it.



2. Enter a time delay on the keypad from 1 to 60 minutes before the screen saver starts. Press the green tick to confirm.

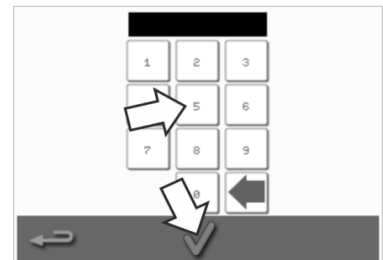

3. An active screen saver will mask the screen showing a moving image. To use the touchscreen, tap the screen to deactivate the screen saver.



2G. Cool-down procedures



The microwave combination oven must be cooled down properly before cleaning, servicing or repairing. Users must read *Section 1J: Hazards and safety precautions during servicing and repair* and *Section 1K: Hazards and safety precautions when taking the appliance out of service*.

To cool down the appliance:

1. Select the thermometer symbol from the cookbook or the cleaning symbol from the main menu (full serve mode).

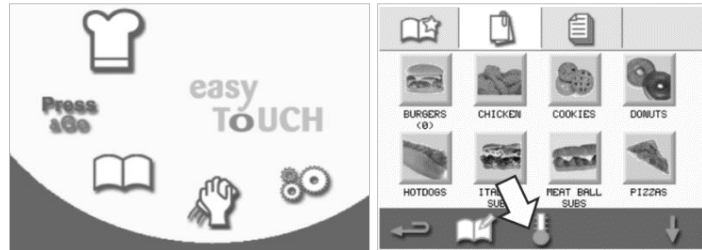

2. In the temperature screen, select the blue thermometer symbol to disable heating and start the cooling cycle.



3. The cooling progress is displayed and takes approximately 20 minutes. To reduce the cool-down time, leave the appliance door open slightly during the cooling process.

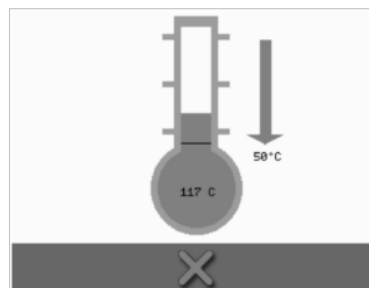

4. Once the cooling process is complete, you will see a 'Clean Cavity' screen. The oven is now ready for cleaning or servicing and repairing.

Cleaning instructions is provided in *Section 2H: Cleaning procedures*.

Servicing and repairing is covered in the *Service and Repair Guide*.



2H. Cleaning procedures

Daily cleaning tasks

What must be cleaned?	Procedure	Cleaning chemicals
Cavity	Clean by hand with a soft cloth or paper towel	Cleaning and protective chemicals approved by the manufacturer
Outside of appliance	Clean by hand with a soft cloth	Common household stainless-steel cleaner or hard surface cleaner
Containers, baking sheets, shelf grills and other accessories used for cooking	Clean by hand with a soft non-abrasive sponge and rinse off after with water	Common household detergent
Air filter	Wipe clean or wash in soapy water	Common household detergent

Table 2.5: Cleaning tasks

Cleaning items

Use solely the cleaning chemicals specified in Table 2.6 to clean the microwave combination oven and its accessories.







Product		Use
Merrychef Cleaner		Cleaning the cavity and appliance door
Merrychef Protector		Protecting the cavity and appliance door
Common household stainless-steel cleaner or hard surface cleaner		Caring for the external surfaces of the microwave combination oven
Common household detergent: mild on skin, alkali-free, pH-neutral and odourless		Cleaning components and accessories and fittings according to relevant instructions
Protective rubber gloves		To protect hands from cleaning agents
Non-abrasive nylon scrub pad		For all surface and door cleaning
Cleaning towel and cloths		For all surface and door cleaning
Eye protection		To protect eyes from cleaning agents
Dust mask (optional)		To protect from inhaling cleaning agents

Table 2.6: Cleaning items



Cleaning instructions



- Ensure the oven has been cooled down as per the instructions in *Section 2G: Cool-down procedures*.
- Users must read *Section 1I: Hazards and safety precautions during cleaning*.
- Wear protective glasses and protective rubber gloves during cleaning.

CAUTION

- Never use sharp implements or harsh abrasives on any part of the appliance.
- Do not use caustic cleaners on any part of the appliance or cavity.
- Do not scrub the roof (jet plate) or door seal.
- Do not use metallic scourers on any part of the appliance at any time.
- Do not spray cleaning product directly into the cavity.
- Do not use the appliance without a clean air filter in place.

Pre-cleaning checklist

- The appliance has been cooled down correctly
- No food has been left in the cavity.
- All containers, baking sheets, shelf grills and any other accessories have been removed from the cavity.

Cleaning process

There are several stages in the cleaning process:

Stage 1: Clean and dry the oven and oven parts

Stage 2: Apply oven protector (optional)

Stage 3: Clean the air filter and external surfaces

Stage 4: Cure the protective chemical (if oven protector applied)



Stage 1: Clean and dry the oven and oven parts

1. In a cooled-down oven (see section 2G), open the door and remove the cook plate and any other cooking accessories.

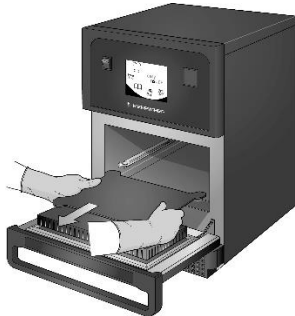

2. Wash all removed oven parts in warm soapy water. Wash off using a clean cloth and plenty of warm water.

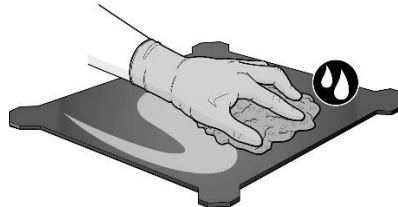

3. Use a dry clean brush to remove any food particles from between the cavity floor and the inside of the front door.

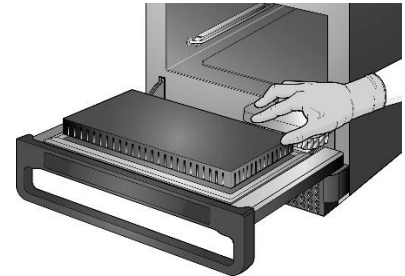

4. Spray Merrychef approved cleaner onto a sponge and clean all internal surfaces **except the cavity roof (jet plate) and door seal**.

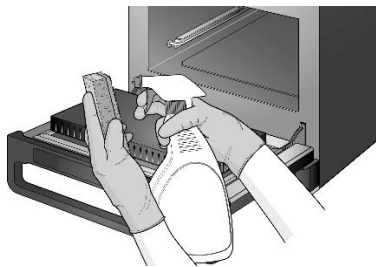

Do not spray directly into the cavity.

5. For difficult areas, leave to soak for 10 minutes with the appliance door open. Use a non-abrasive nylon scrub.

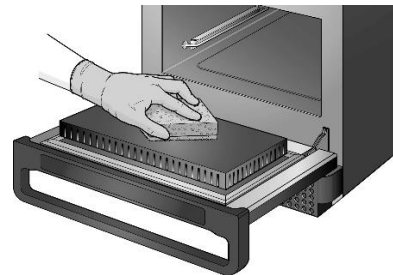

Do not scrub.

6. Wash off all surfaces using a wet clean cloth. The cavity roof and door seal can be wiped clean with a wet clean cloth as well.

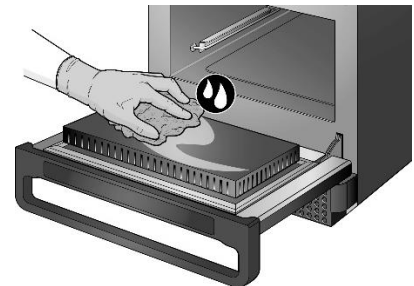

7. Dry all surfaces and oven parts using a clean cloth or paper towel.

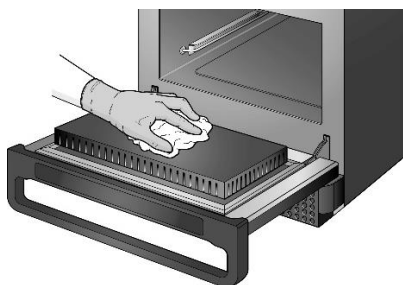

8. Press the tick on the clean cavity screen to continue.



9. A prompt will appear to apply the oven protector (optional).

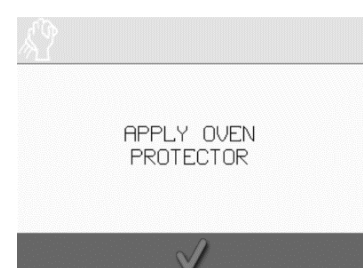

Stage 2: Apply oven protector (optional)

1. Spray Merrychef protector or a Merrychef approved protector onto a clean sponge.

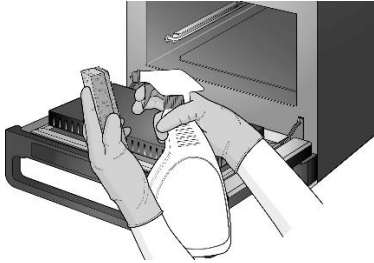

2. Spread the protective chemical lightly onto all internal surfaces, avoiding the roof (jet plate) and door seal.

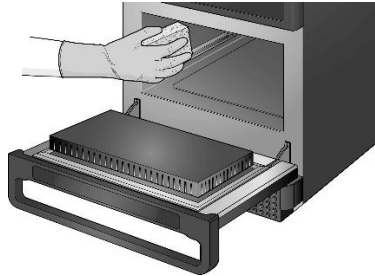

3. Replace the cleaned and dried cook plate.

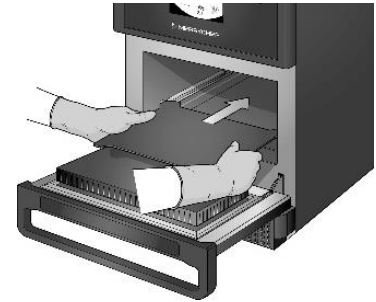

4. Press the tick on the apply oven protector screen to continue.



5. A prompt appears to clean the air filter.



Stage 3: Clean the air filter and external surfaces

1. Remove the air filter by gently pulling it.

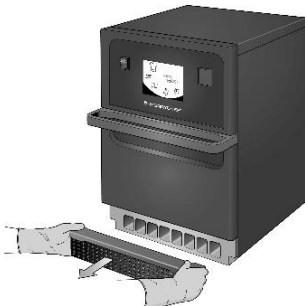

2. Wipe the air filter clean or wash in soapy water.

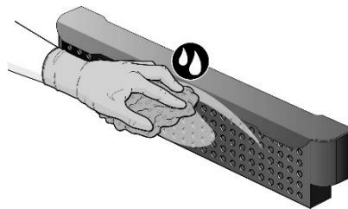

3. Dry and replace the air filter.

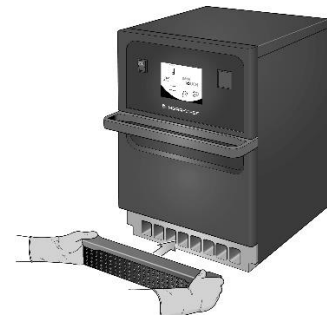

4. Press the green tick to confirm cleaning of the air filter.

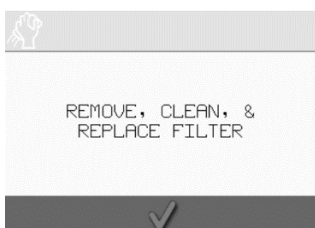

5. The oven switches OFF automatically.

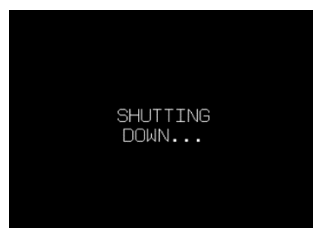

6. Wipe the external surfaces of the oven with a damp cloth.



Stage 4: Cure protective chemical (if oven protector applied)

1. Switch ON the appliance using the on/off button.



2. Preheat the cavity. Once reaching the preset operating temperature it will take about 30 minutes to cure the protective chemical.

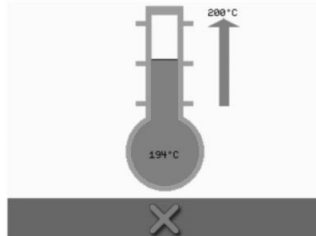

3. The protective chemical turns light brown when cured and the oven is ready to be used again.



2I. End of day operations

Turning the oven off

- 1.



Switch off the microwave combination oven using the on/off switch at the front of the appliance.

- 2.



Leave the appliance door ajar to let moisture escape.

Note: Switch off the power on site, before prolonged breaks in use.



2J. Servicing information

Warranty information and contacting customer services

In order to be able to claim under the warranty for the microwave combination oven, the appliance must be installed in accordance with the instructions in the *Operations and Installation Guide* by a qualified service engineer from an authorised service company.

The warranty does not cover damage resulting from improper setup, installation, use, cleaning, use of cleaning chemicals, servicing or repair.

Required information

Please have the following appliance data to hand when contacting Welbilt customer service:

- Serial number of your appliance
- Part number if you are calling about a specific part of the appliance

This serial number of the appliance can be found at the rear of the oven on the nameplate, as shown in Figure 2.5.



Figure 2.5: e1s rear view with nameplate

Contact data

Welbilt UK Ltd.
Ashbourne House, The Guildway,
Old Portsmouth Road
Guildford, GU3 1LR
United Kingdom
Tel: +44 (0) 1483 464900
Fax: +44 (0) 1483 464905
Website: www.merrychef.com and www.welbilt.com



For further information on servicing, maintenance and repair, please refer to the *Service and Repair Guide*.



Fault finding

Although every effort is made to ensure your oven will continue to perform to a high standard, please check Table 2.7 to see if the problem can be easily resolved before contacting your service agent.

Problem	Possible cause	Remedy
The appliance does not work and the display screen is blank	<ul style="list-style-type: none"> • The appliance has no power 	<ul style="list-style-type: none"> • Check if there is a power cut • Check if the isolator switch is ON or the appliance is plugged in correctly • Check if the appliance switch is ON
Some screen controls do not work	<ul style="list-style-type: none"> • Unauthorised access 	<ul style="list-style-type: none"> • Contact an authorised user
Display shows a warning message	<ul style="list-style-type: none"> • Details are shown on screen 	<ul style="list-style-type: none"> • Follow the instructions displayed
The appliance does not cook the food correctly	<ul style="list-style-type: none"> • Appliance is not clean • Food not at correct temperature • Modified or wrong programme selected • Food wrapped • Food removed early 	<ul style="list-style-type: none"> • Clean the appliance • Use the correct cooking programme • Unwrap food • Check if all the cooking stages have been followed correctly
The appliance does not finish cooking	<ul style="list-style-type: none"> • Warning message displayed • The appliance door is open • No air filter or incorrectly fitted • Overheating of the appliance 	<ul style="list-style-type: none"> • Close the appliance door • Refit the air filter • Allow the appliance to cool down • Check and remove any restrictions around the air vents
Display shows an error code	<ul style="list-style-type: none"> • Malfunction of the appliance 	<ul style="list-style-type: none"> • Note the error code and contact your service agent

Table 2.7: Fault finding guidelines



For further information on servicing, maintenance and repair, please refer to the *Service and Repair Guide*.



eikon[®] e1s

Microwave Combination Oven



Welbilt is one of the world's largest manufacturers and suppliers of professional gastronomic appliances. We supply our customers with energy-saving, reliable and market-leading technologies from a single source. If you want to find out more about Welbilt and its company brands, please visit us at www.welbilt.com