



INSTALLATION, OPERATION & MAINTENANCE MANUAL

Pizza Prep Tables

Sandwich/Salad Units

**Under-counter Refrigerators
and Freezers**

**Worktop Refrigerators and
Freezers**

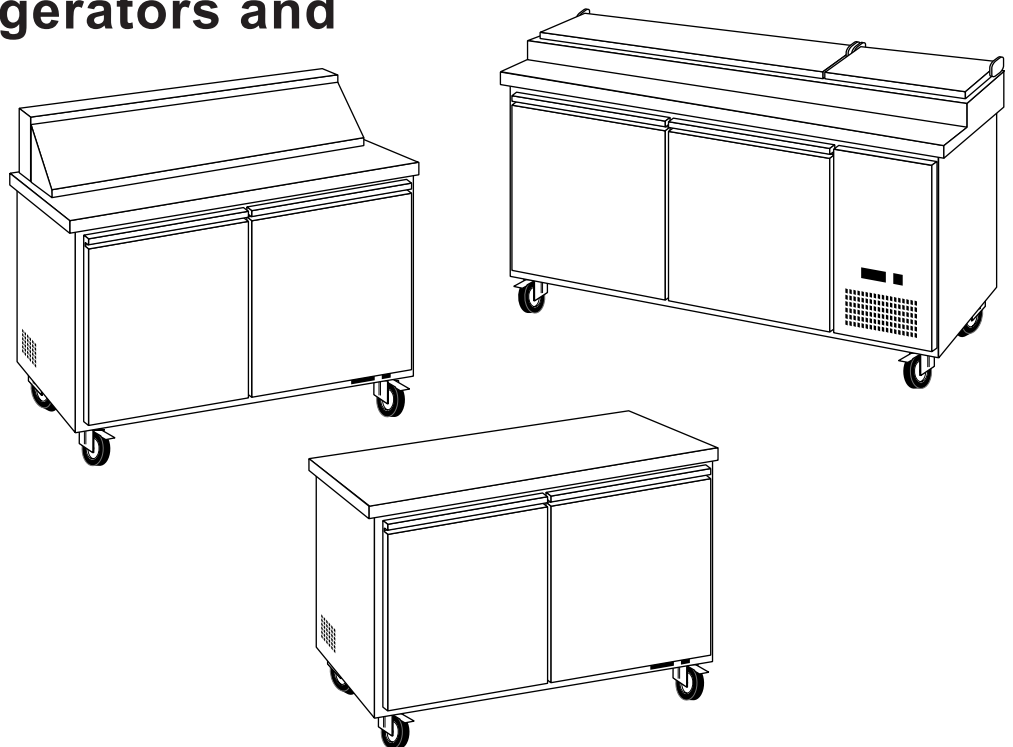

IMPORTANT

**Please read this manual completely
before attempting to install or operate this equipment.**

TABLE OF CONTENTS

SPECIFICATIONS	3
REGISTRATION	4
SAFETY INSTRUCTIONS	5
INTRODUCTION	6
Site Preparation.....	6
RECEIVING AND INSPECTING	6
Serial Number Location.....	6
INSTALLATION	7
Location	7
Inside cabinet	7
Outside cabinet.....	7
Electrical connection	7
Leveling	7
Stabilizing.....	7
OPERATION	8
Refrigerated Cabinets	8
Defrosting.....	8
On/Off Switch	8
Front Panel Controls and Indicators.....	8
Functions.....	9
Display the set point:.....	9
Change the set point:	9
Manual Defrost.....	9
Keyboard Lock	9
Keyboard Unlock.....	9
Alarm Codes.....	9
Display and Reset Alarm	9
MAINTENANCE	10
Refrigerators and Freezers	10
Cleaning the Condenser Coil	10
Stainless Steel Care and Cleaning	10
Gasket Maintenance	11
Doors/Hinges.....	11
Drain Maintenance	11
Door Replacement and Adjustment.....	11
Open the Bottom Shroud.....	11
WIRING DIAGRAMS	12
Models: APP-48R,APP-71R,AUC-27R, AUC-48R	12
Models: AST-28R	12
Models: AST-48R,	13
Models: AUC-27FZ, AUC-48F.....	13
Models: APP-48R	14
Models: APP-71R	15
Models: AST-28R, AST-48R, AUC-27R, AUC-48R.....	16
Models: AUC-27F, AUC-48F.....	17
ARCTIC AIR WARRANTY	18

SPECIFICATIONS

PIZZA PREP TABLES										
MODEL #	V/Hz/Ph	AMPS	STORAGE CAPACITY	PAN 1/3	SHELF CAPACITY	HP	BTU	CHARGE	SHIP WEIGHT	NEMA PLUG
			Cu-ft	Size	Sq-ft				Lbs	
APP-48R	115/60/1	7	12	6	16	1/2	5600	9.9	348	5-15P
APP-71R	115/60/1	7.5	22	9	34	1/2	6200	10.6	432	5-15P

SANDWICH/SALAD UNITS										
MODEL #	V/Hz/Ph	AMPS	STORAGE CAPACITY	PAN 1/6	SHELF CAPACITY	HP	BTU	CHARGE	SHIP WEIGHT	NEMA PLUG
			Cu-ft	Size	Sq-ft				Lbs	
AST-28R	115/60/1	5	7	8	14	3/8	3200	9.5	276	5-15P
AST-48R	115/60/1	7	12	12	26	1/2	5400	9.5	313	5-15P

UNDERCOUNTER & WORKTOP REFRIGERATORS										
MODEL #	V/Hz/Ph	AMPS	STORAGE CAPACITY	SHELF CAPACITY	HP	BTU	CHARGE	SHIP WEIGHT	NEMA PLUG	
			Cu-ft	Sq-ft				Lbs		
AUC-27R	115/60/1	5	6.5	14	3/8	2800	9.5	243	5-15P	
AUC-48R	115/60/1	5	12	26	3/8	3000	9.5	300	5-15P	

UNDERCOUNTER FREEZERS										
MODEL #	V/Hz/Ph	AMPS	STORAGE CAPACITY	SHELF CAPACITY	HP	BTU	CHARGE	SHIP WEIGHT	NEMA PLUG	
			Cu-ft	Sq-ft				Lbs		
AUC-27FZ	115/60/1	7	6.5	14	1/2	3500	12.3	291	5-15P	
AUC-48F	115/60/1	9	12	26	1/2	3800	13.4	340	5-15P	

REGISTRATION

The installation date and appliance model must be documented by the end purchaser. Also, refer to the Warranty section for additional details on registering the appliance.

Dealer Information:

Installer Information:

Installation Date:

SAFETY INSTRUCTIONS

General Safety



Arctic Air accepts no responsibility for any situation resulting from work carried out in an unprofessional manner, or from the incorrect interpretation or application of regulations.

General Installation



Incorrect installation or any modifications made to the appliance may damage property or result in injury or death.

Electrical



Electrical connections or any work required on the electrical circuits inside the appliance must be performed by certified technicians in compliance with local, state, and federal regulations.



Make sure all facility electrical connections are in compliance with all local and federal electrical code regulations.

Inspection and Maintenance



Appliance maintenance must be carried out by only by suitably trained personnel.



Before any maintenance work is performed, the appliance must be disconnected from the electrical supply. Apply a lockout tag to the electrical supply connection.



All replacement parts that are not supplied by Arctic Air must be pre-approved before installation.

Repair Work Safety



Repair work must only be performed by Arctic Air or one of its authorized representatives. Arctic Air accepts no responsibility for any situation resulting from work performed by untrained and/or unauthorized technicians.

INTRODUCTION

This manual covers the Under-counter Refrigerators and Freezers. Please read this manual completely before attempting to install or operate this equipment.

Site Preparation

The installation site must be cleaned and prepared prior to the equipment delivery.

- Refer to the SPECIFICATIONS and have a licensed electrician confirm that all electrical requirements are satisfied.
- Confirm that all flooring is structurally strong enough to support the weight of a fully loaded unit; a fully loaded unit can weigh as much as 1500 pounds. Consult with a structural engineer for confirmation if there is any reason to doubt the floor strength.
- Confirm that adequate ventilation has been provided, and that the unit will not be located close to a heat source.
- For all units on casters, confirm that the floor is level where the unit is to be located.

RECEIVING AND INSPECTING

Exercise care to prevent damaging the equipment during unloading and on-site transporting.

1. Visually inspect the exterior of the package, skid and/or container. Report any damage to the carrier immediately.
2. If any packaging damage is noted, open and inspect the contents with the carrier.
3. If concealed damage is discovered after unpacking the equipment notify the carrier. Notification must be made both in writing and verbally.
4. Check the compressor compartment housing and visually inspect the refrigeration package. Confirm that the lines are secure and the base is intact.

5. Request the required damage forms and an equipment damage inspection by the shipping company. The inspection should be performed within 10 days from receipt of the equipment.
6. Retain all crating material until an inspection has been performed or waived.

Serial Number Location

The serial number of all self-contained refrigerators and freezers is located inside the unit on the left hand side near the top on the wall. Have the serial number available when calling for parts or service.

This manual covers only standard units. For a custom unit, consult the customer service department. See the customer service phone number listed on the last page.

INSTALLATION

Location

All units are intended for indoor use only. A fully loaded unit can weigh as much as 1500 pounds. Choose a location with a level floor strong enough to support the total weight of a fully loaded unit. Reinforce the floor if necessary.

For the most efficient refrigeration, provide good air circulation around the unit.

Inside cabinet

Do not pack the unit interiors so that air circulation is impeded. The refrigerated air is discharged at the top rear of the unit. Allow for proper air flow from the top rear to the bottom of the unit. Obstructions to this air flow can cause evaporator coil freeze ups and loss of temperature or overflow of water from the evaporator drain pan. The shelves have a rear turn up on them to prevent obstructions to the rear air flow. However, bags and other items located at the rear of the cabinet may obstruct the air flow.

Outside cabinet

Be sure that the unit has access to ample air flow. Avoid hot corners and locations near stoves and ovens. Do not install the unit closer than two inches from a wall. To prevent air obstruction, do not locate large boxes and/or tall stacks of product that might obstruct the air exhaust or the air inlet.

CAUTION

If the unit is laid on its side or back for any reason, allow a minimum of 24 hours in the upright position, before start-up to allow compressor oil to flow back to the sump. Failure to meet this requirement can cause compressor failure, unit damage, and will void the unit warranties.

Electrical connection

Refer to the amperage data provided in the SPECIFICATIONS, the serial tag, the local electrical code and/or the National Electrical Code. Have a licensed electrician confirm that the facility wiring is adequate for the unit and that a protected circuit of the correct voltage and amperage is provided for each unit. Confirm that the unit is connected only to the proper protected power source.



TURN THE ON/OFF SWITCH TO OFF AND DISCONNECT THE UNIT FROM THE POWER SOURCE WHENEVER PERFORMING SERVICE, MAINTENANCE FUNCTIONS OR CLEANING THE UNIT.

Leveling

Level the cabinet to improve performance, to better align the doors, to reduce uneven strain on the cabinet and reduce movement of the contents on the shelves. Use a level to level the unit from front to back and side to side. Units supplied with legs have adjustable bullet feet to make the leveling adjustments. If the unit is supplied with casters, no leveling adjustments are available. Ensure the floor is level, where the casters unit is located.

Stabilizing

Casters are provided for convenience, ease of cleaning underneath and for mobility. Install the unit on a level surface, in a stable condition and lock the front wheels to prevent movement.

OPERATION

Refrigerated Cabinets

The internal temperature range for all food prep units, under-counter and worktop refrigerators is 34°F to 38°F. The internal temperature range for under-counter and worktop freezers is -3°F to -7°F. The rail temperature range for all prep units is 33°F to 41°F. Operate the food prep units only with the pans in place. Operating food prep units without pans and/or pan covers in place lowers the efficiency and may damage the unit due to continuous running. Opening and closing the door must be minimized to allow the unit to maintain optimum refrigeration temperature. Top section is not intended for overnight storage. Product must be removed from pans. Empty pans can remain in cabinet.

Defrosting

Every 6 hours, the unit turns off and the controller displays the defrost symbol. This allows the evaporator coil to clear the ice. When the coil temperature reaches the terminal temperature (or after 20 minutes) the unit re-starts.

On/Off Switch

The on/off switch for the Pizza Prep tables is located on the condenser compartment door. For the remaining units, the on/off switch is located on the front of the bottom shroud. When the unit is on, the green LED is on.

Front Panel Controls and Indicators

The front panel controls and indicators are used to set and display the unit functions and status.

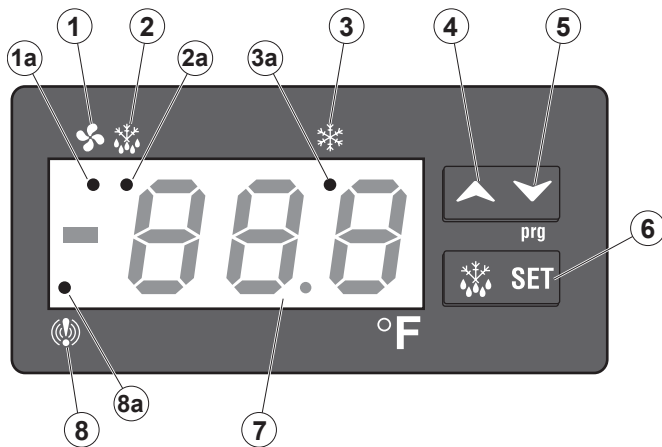

Callout No.	Control / Indicator	Function
1	Fan	Indicates the fans are running.
2	Defrost	Press to start the manual defrost cycle.
3	Compressor	Indicates the compressor is running.
4	Up Arrow	To display the last temperature alarm. In programming mode it browses the parameter codes or increases the displayed value.
5	Down Arrow	To display the last temperature alarm. In programming mode it browses the parameter codes or decreases the displayed value.
6	SET	Used to display a target set point; in programming mode it elects a parameter or confirm an operation.
7	Display	Indicates the room temperature, the set points and the alarm codes.
8	Alarm	Indicates a temperature alarm.

Key combinations are used to perform functions that cannot be performed with a single key.

Key Combinations		
Press Keys		Result
Up Arrow	Down Arrow	Locks and unlocks the keyboard.
SET	Down Arrow	Enters the programming mode.
SET	Up Arrow	Returns to the room temperature display.

The LED functions display operational conditions.

Callout No.	Mode	LED Function
1a	On	Fans enabled
	Flashing	Fans delay after defrost in progress
2a	On	Defrost enabled
	Flashing	-Programming phase (flashing with "icon") - Drip time in progress
3a	On	Compressor enabled
	Flashing	-Programming phase (flashing with "icon") -Anti-short cycle delay enabled
8a	On	A temperature alarm happened

Functions

Display the set point:

1. Press and release the SET button, the set point value is displayed.
2. Press and release the SET button (again) or wait five seconds to return to the probe value display.

Change the set point:

1. To change the set point value, press the SET button and hold for a minimum of two seconds.

The set point value is displayed and the Compressor LED starts blinking.

2. For the next ten seconds, the set value can be changed using the Up Arrow or the Down Arrow buttons.
3. To save the new set point value press the SET key again (or wait ten seconds).

Manual Defrost

Press the Defrost button and hold for a minimum of two seconds. The manual defrost cycle starts.

Keyboard Lock

1. Press the Up Arrow and Down Arrow buttons and hold for a minimum of three seconds.
2. The "POF" message is displayed when the keyboard is locked. With the keyboard locked only the set point or the max/min temperature is displayed.
3. If any key is pressed for more than three seconds the "POF" message is displayed.

Keyboard Unlock

Press the Up Arrow and Down Arrow buttons and hold for a minimum of three seconds. The "Pon" message is displayed when the keyboard is unlocked.

Alarm Codes

CODE	CAUSE	OUTPUTS
P1	Room probe failure	Compressor output according to par Con and COF
P2	Evaporator probe failure	Defrost end is timed
P3	Condenser probe failure	Outputs unchanged
HA	Maximum temperature alarm	Outputs unchanged
LA	Minimum temperature alarm	Outputs unchanged
dA	Door open	Compressor and fans restart
EA	External alarm	Outputs unchanged
CA	Serious external alarm (i1F=bal)	All outputs off
CSd	Condenser alarm	All outputs off

Display and reset alarm

1. Press the Up Arrow and Down Arrow buttons to display the alarm code.
2. Press and hold the SET button until the reset (rst) message is displayed then release.

Press the SET button again, the reset (rst) message blinks and the room temperature is displayed.

MAINTENANCE



TURN OFF THE POWER SWITCH AND DISCONNECT THE UNIT FROM THE POWER SOURCE WHENEVER PERFORMING SERVICE/ MAINTENANCE FUNCTIONS AND/OR CLEANING THE REFRIGERATED AREA.

Refrigerators and Freezers

Clean the interior and exterior using soap and warm water. If this is not sufficient, use ammonia and water or a nonabrasive liquid cleaner. When cleaning the exterior, always rub with the stainless steel grain to avoid marring the finish.

Do not use an abrasive cleaner, it may scratch the stainless steel and/or the plastic. Abrasive cleaners can also damage the breaker strips and gaskets.

Cleaning the Condenser Coil

Clean the condenser coil a minimum of every 90 days. If there is a large amount of debris, dust or grease accumulation prior to the 90 day cycle, reduce the cleaning cycle to every 30 days.

If the buildup on the coil consists of only light dust and debris, clean the condenser coil using a brush. For heavier dust buildup, use a vacuum or compressed air.

If heavy grease is present use a refrigeration degreasing agent designed specifically for the condenser coils. Spray the condenser coil with degreasing agent and blow through with compressed air.

Failure to maintain a clean condenser coil can initially cause high temperatures and excessive run times. Continuous operation with dirty or clogged condenser coils may result in compressor failures. Neglecting the condenser coil cleaning procedures will void any warranties associated with the compressor.



Never use a high pressure water wash for this cleaning procedure as water can damage the electrical components located near or on the condenser coil.

Stainless Steel Care and Cleaning

Stainless steel contains 70-80% iron which will rust. It also contains 12-30% chromium which forms an invisible passive film over the steel's surface that acts as a corrosion shield. As long as the protective layer remains intact, the metal remains stainless. If the film is broken or contaminated, outside elements can break down the steel and begin to form rust or discoloration.

To properly clean stainless steel, use soft cloths or plastic scouring pads.



Never use steel pads, wire brushes or scrapers to clean stainless steel surfaces.

Cleaning solutions must be alkaline based or non-chloride cleaners. Any cleaner containing chlorides will damage the stainless steel protective film. Chlorides are also commonly found in hard water, salts, and household and industrial cleaners. If cleaners containing chlorides are used, be sure to rinse repeatedly and dry thoroughly upon completion.

Perform routine stainless steel cleaning with soap and water. Extreme stains or grease should be cleaned with a non-abrasive cleaner and plastic scrub pad (rub with the grain). There are also stainless steel cleaners available which can restore the protective layer and preserve the finish.

Early signs of stainless steel breakdown may consist of small pits and cracks. If these early signs are present, clean thoroughly and apply a cleaner specifically designed for stainless steel cleaners to attempt to restore the passivity.



Never use an acid based cleaning solution. In addition, many food products have an acidic content which can deteriorate the finish. Be sure to clean the stainless steel surfaces of all food products. Common acidic based food items include; tomatoes, peppers and other vegetables.

Gasket Maintenance

Gaskets require regular cleaning to prevent mold and mildew buildup and to maintain the gasket elasticity. Clean gaskets with warm soapy water. Avoid full strength cleaning products on gaskets, this can cause the gaskets to become brittle and prevent proper sealing. Never use sharp tools or knives, which could tear the gasket and/or rip the bellows, to scrape or clean the gasket.

Gaskets are easy to replace and do not require the use of tools. To remove and replace the Dart style gasket, pull the gasket out of the groove in the door and press the new gasket back into place.

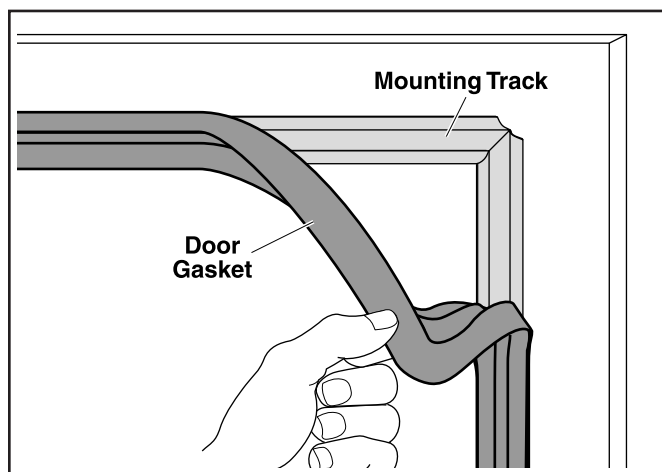

Doors/Hinges

Over time the door hinges may become loose. If the doors are loose or sagging, this can cause the hinge to pull out of the frame which may damage both the doors and the door hinges. Tighten the screws that mount the hinge brackets to the frame of the unit. If this does not solve the issue call a qualified service agent.

Drain Maintenance

The drain located inside all of the units removes the condensation from the evaporator coil and evaporates it at an external condensate evaporator pan. Moving or bumping the drain may cause the drain to become loose or disconnected. If excessive water accumulates on the inside of the unit make sure the drain tube is connected from the evaporator housing to the condensate evaporator drain pan. If water has collected underneath the unit, check the condensate evaporator drain tube to be sure it is still located inside the drain pan. Leveling the unit is important because the units are designed to drain properly when level. If the floor is not level drain problems may occur. Be sure all drain lines are free of obstructions. Food products blocking drain lines is a common cause of water back up and overflow.

Door Replacement and Adjustment

1. Open the door until it remains open, about 100° to 110°.
2. Loosen and remove the bottom screw on the self-closing cartridge. Remove the three hinge screws, then slide the door down and out.
3. To prepare a new door, rotate the square head of the cartridge shaft approximately 120° in the direction the door closes. This action preloads the hinge and it is now ready to be secured to the bottom hinge.
4. From the closed position, hold the door at about 100°, insert the bottom hinge over the square shaft of the cartridge so that the hinge is facing the cabinet. Once positioned, insert and fasten the mounting screw.
5. Maintain the door/hinge assembly at about 100° and slide it up to the top hinge pin. Confirm proper alignment, and then fasten the bottom hinge.
6. The door must swing closed by itself with no restriction. Confirm that the door swings freely.

Open the Bottom Shroud

Loosen and remove the screw from the two holes in front of the bottom shroud, the bottom shroud can be moved out.

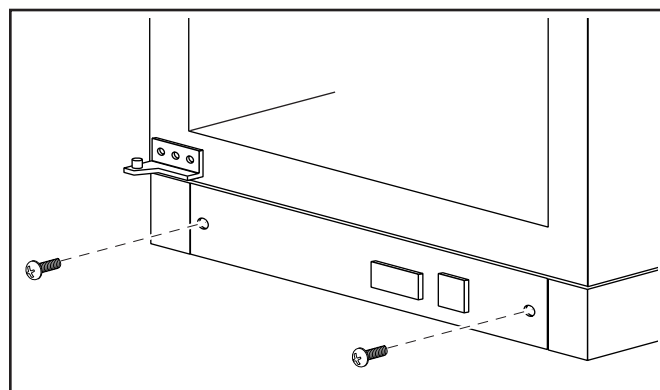

WIRING DIAGRAMS

Models: APP-48R, APP-71R, AUC-27R, AUC-48R

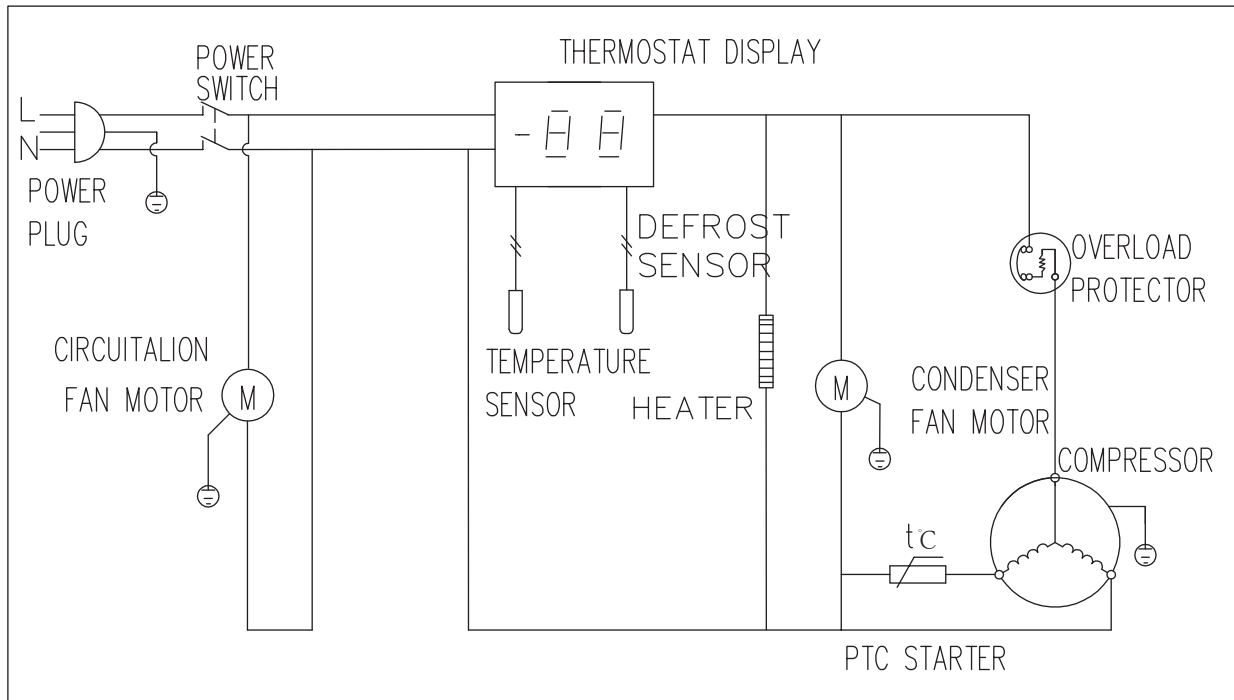

Models: AST-28R

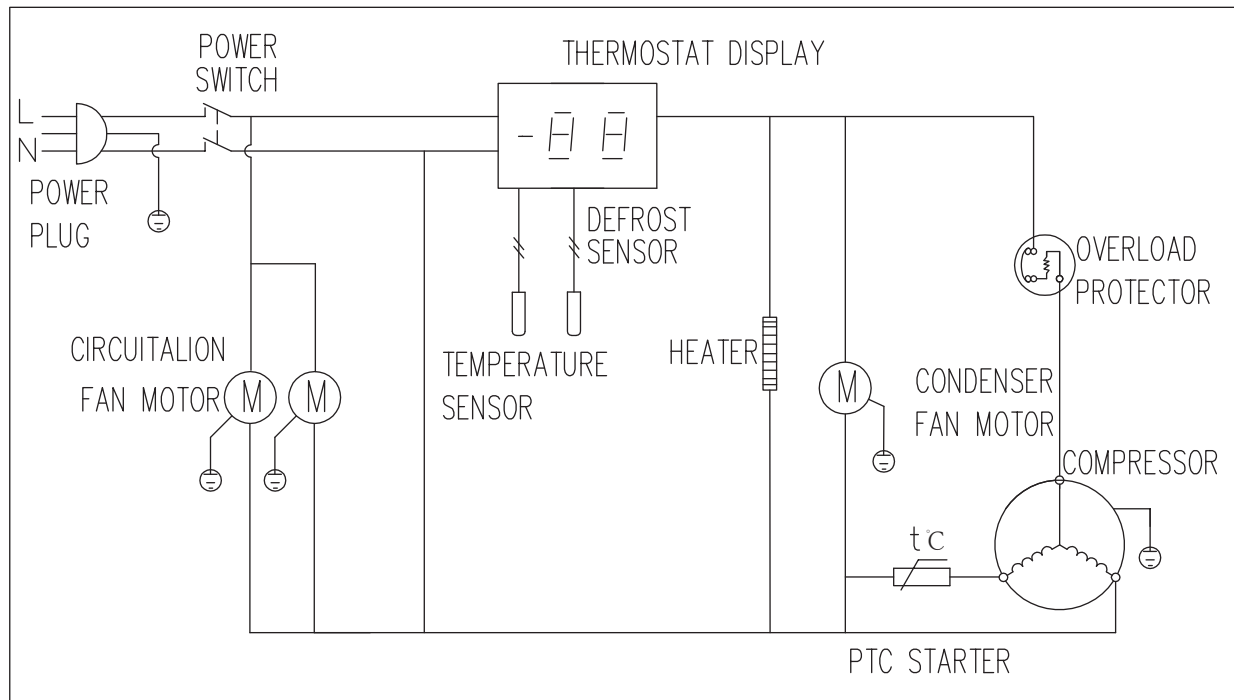

Models: AST-48R

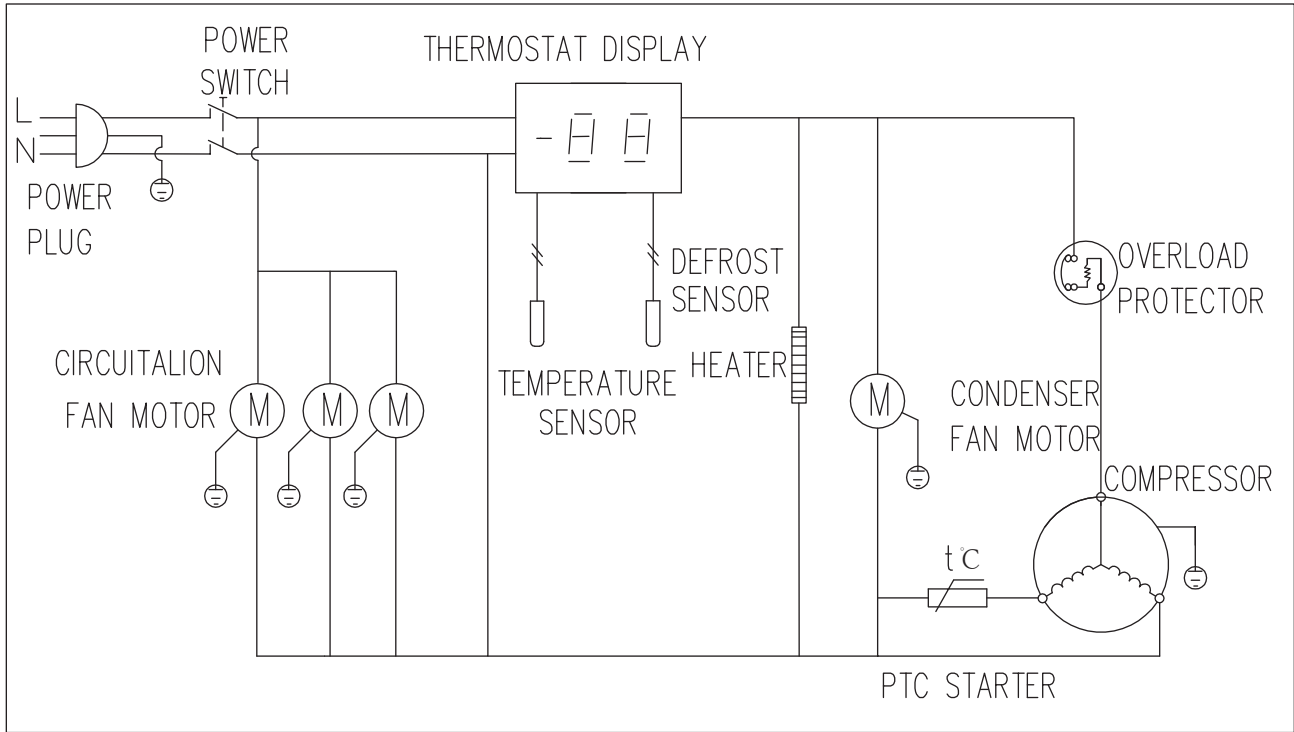

Models: AUC-27FZ, AUC-48F

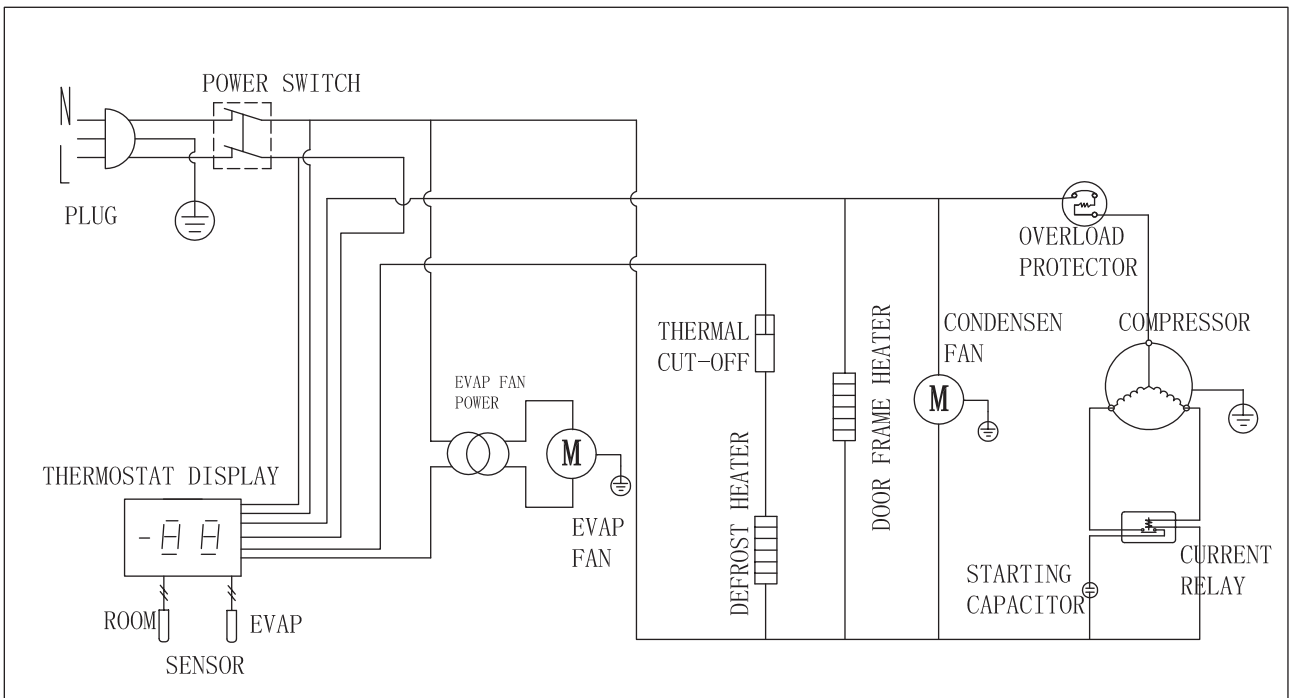

Models: APP-48R

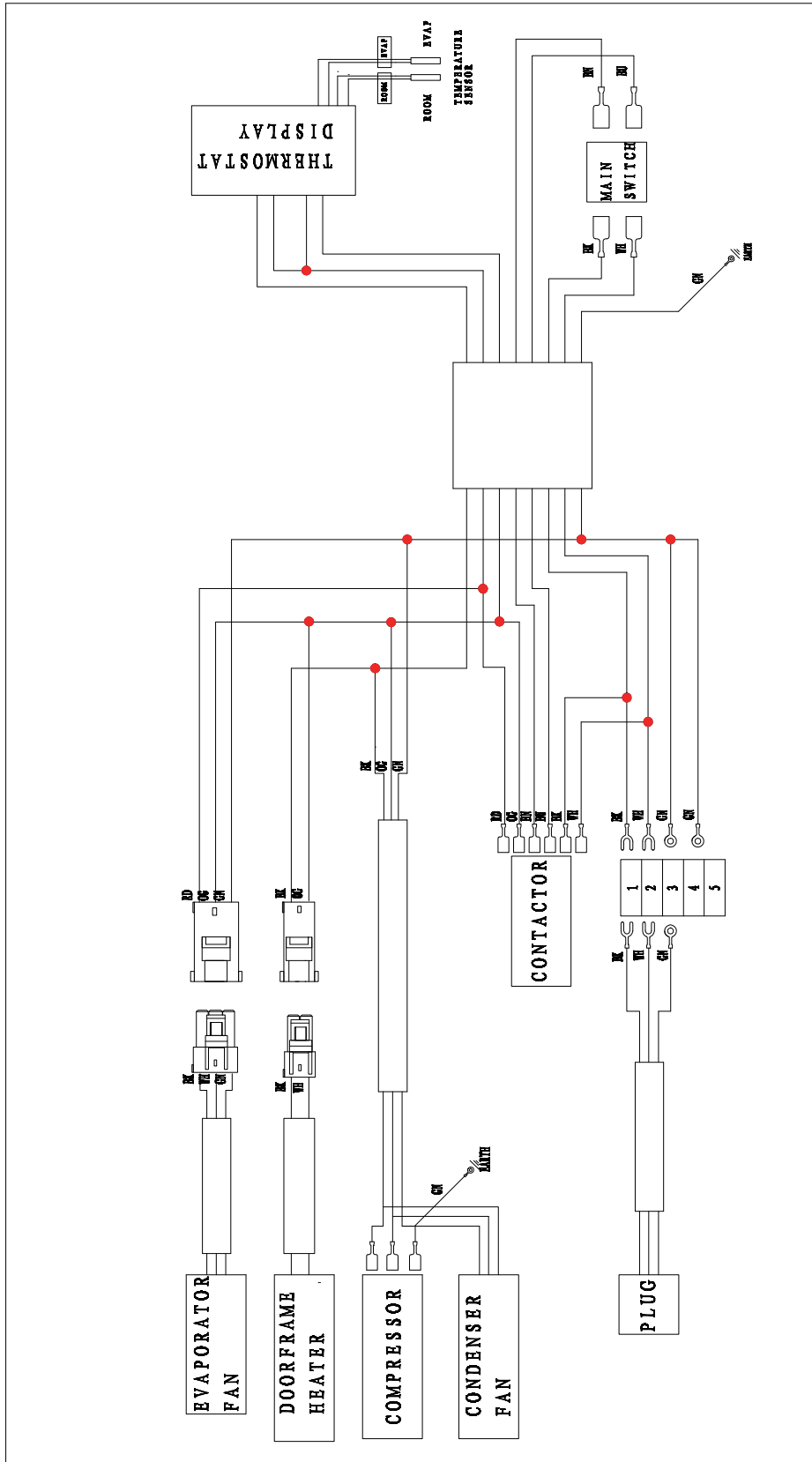

Models: APP-71R

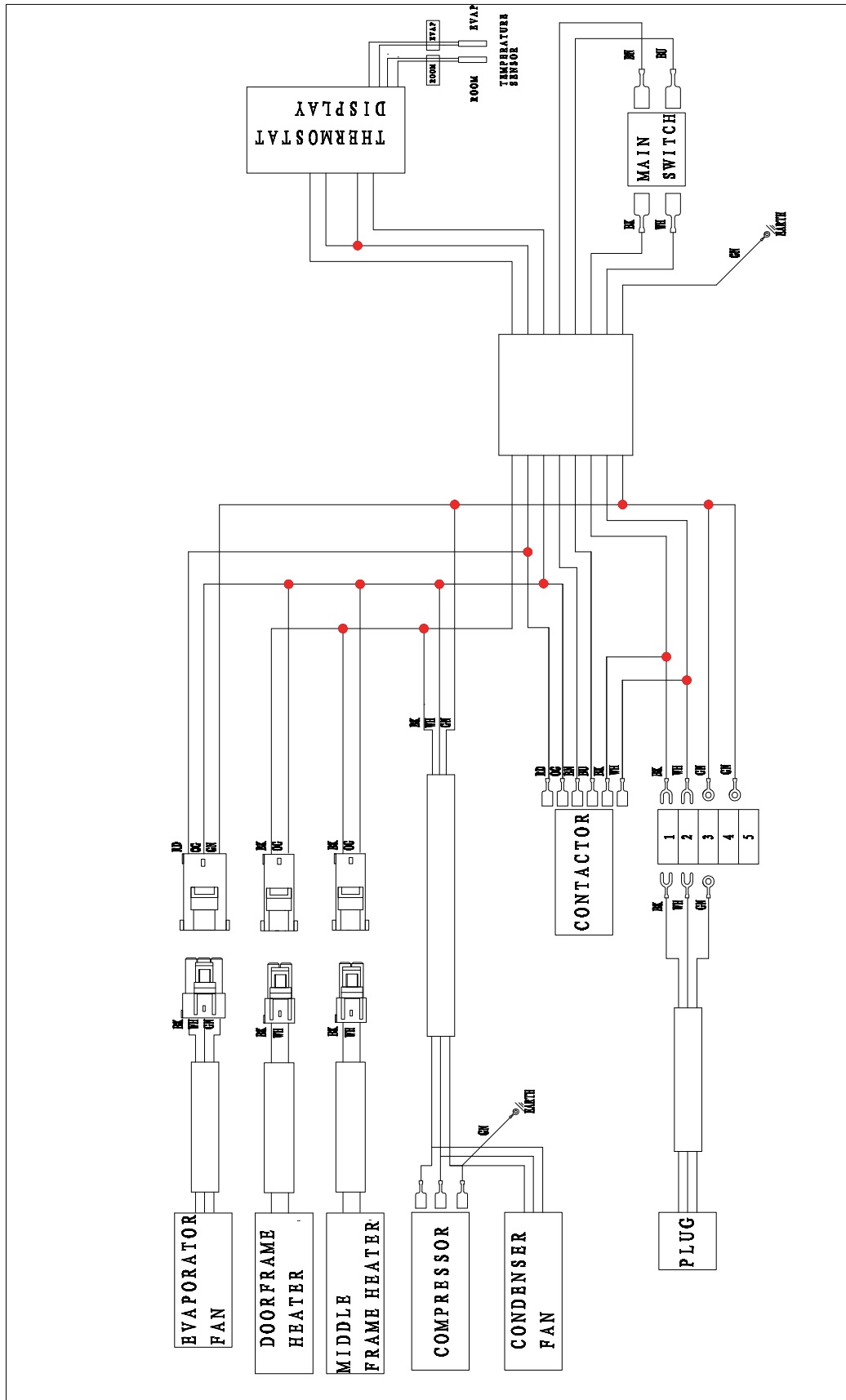

Models: AST-28R, AUC-27R

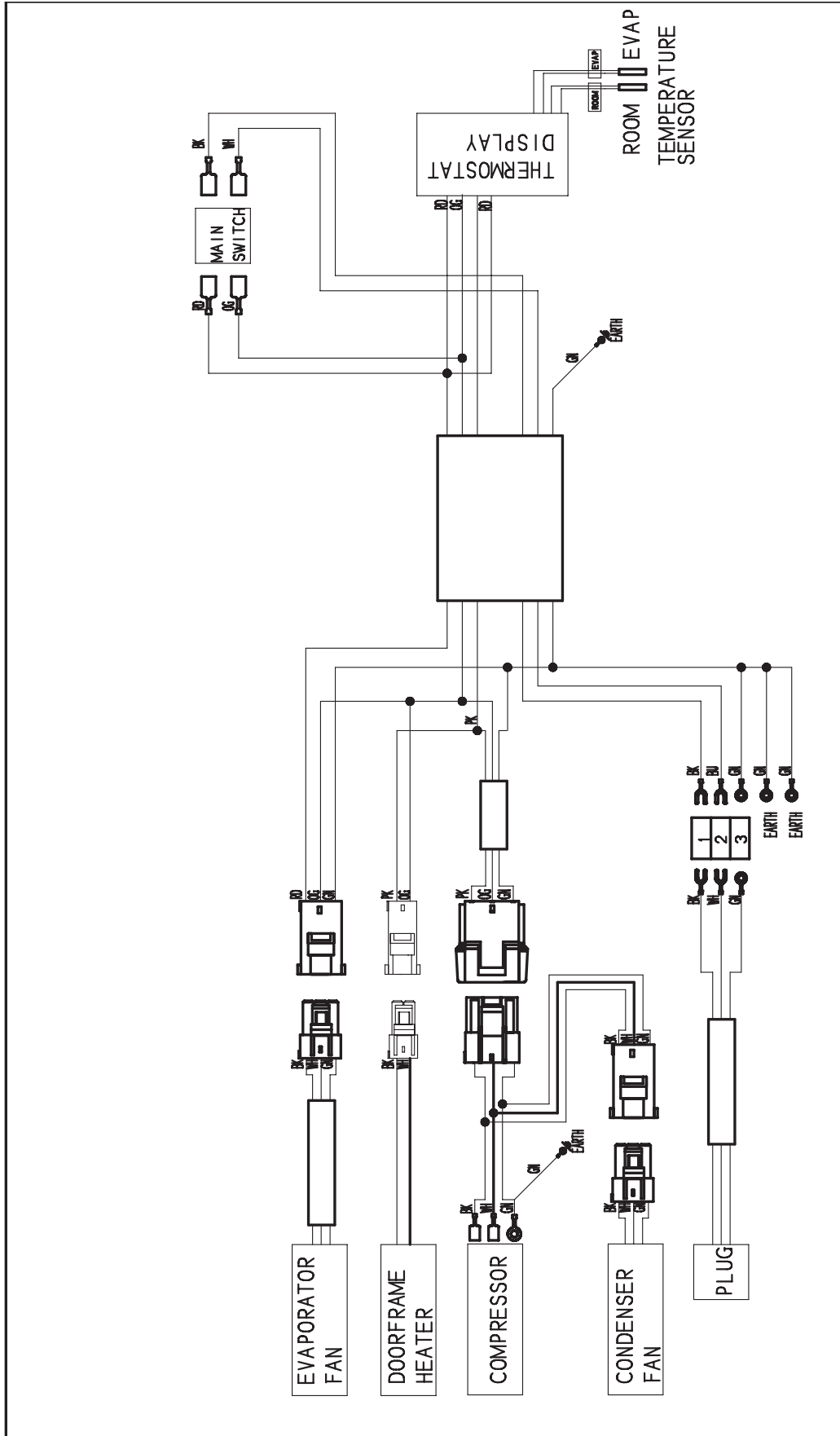

Models: AUC-27FZ

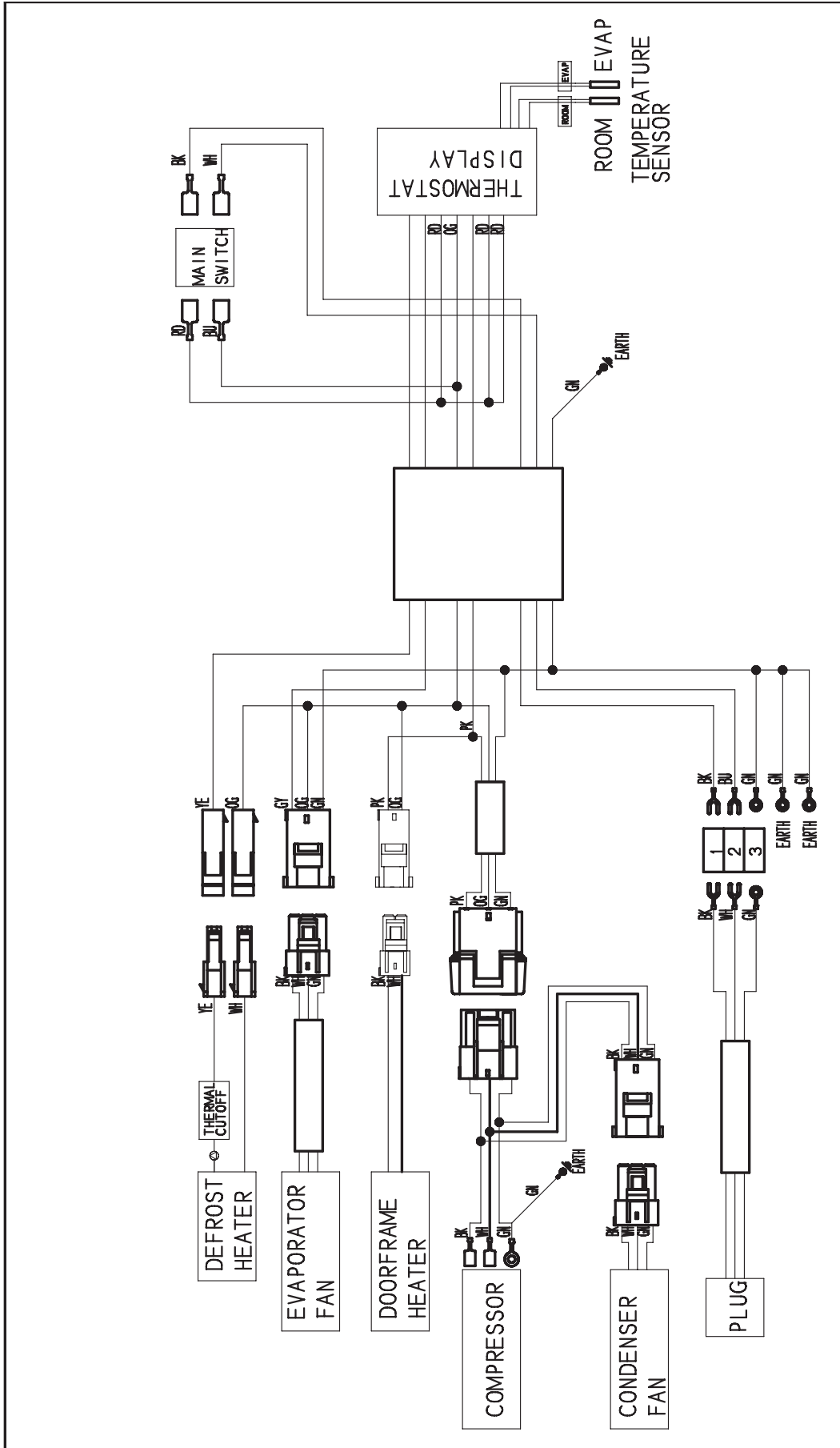

Models: AUC-48F

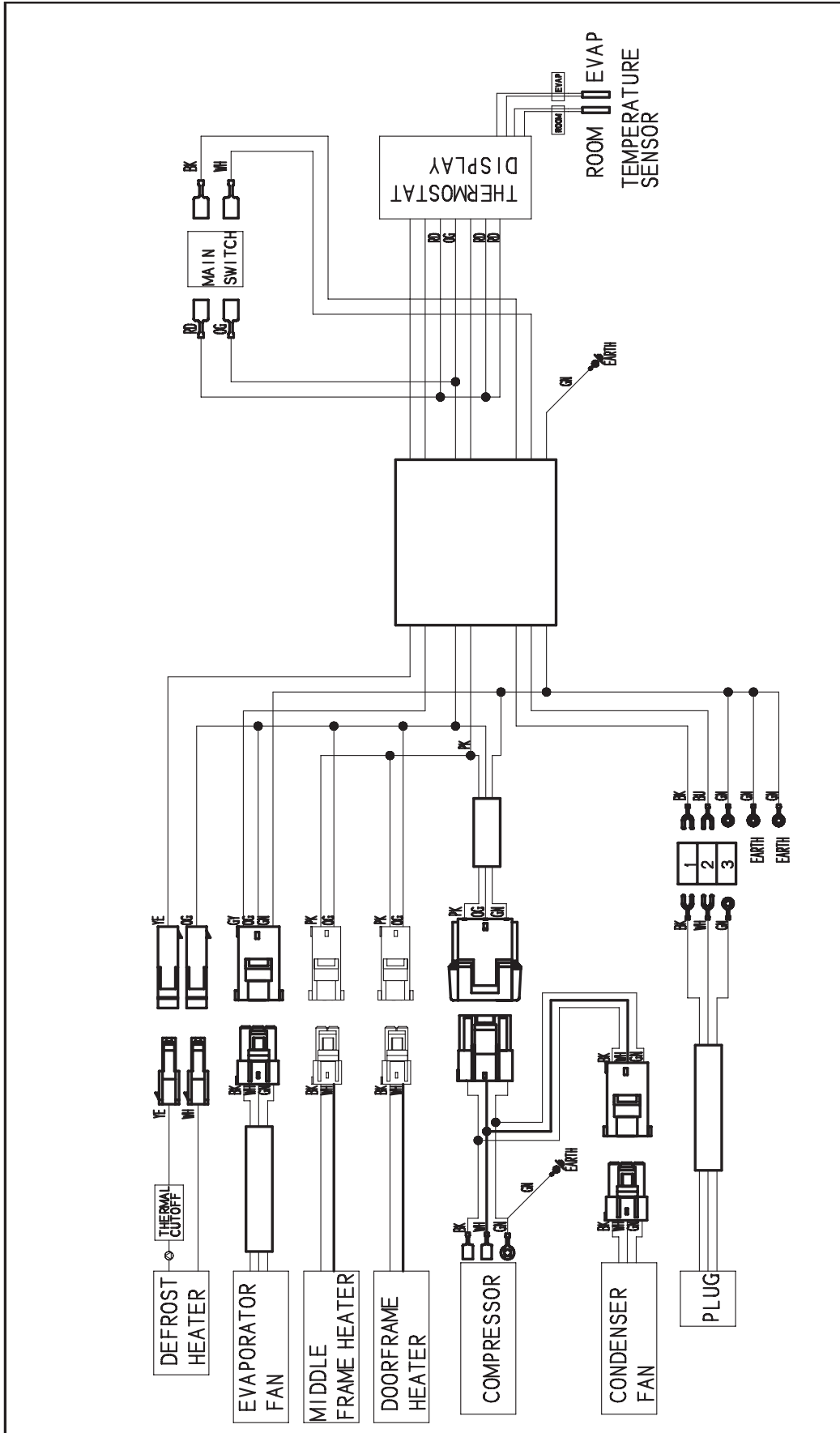

ARCTIC AIR WARRANTY

One year parts & labor warranty

Arctic Air warrants to the original purchaser, all of its new equipment to be free from defects in material or workmanship, under normal use and maintenance service, for a period of one (1) year from the date of original purchase or 15 months after shipment date from the manufacturer, whichever occurs first. Warranty coverage is limited to the repair and/or replacement, including labor charges, of defective parts and/or assemblies. The labor warranty shall include straight time labor charges and travel charges within 100 miles roundtrip. Warranty service must be arranged by calling 1-855-431-5558 for service in the United States and Canada. Warranty service coverage is not offered outside of the United States and Canada.

Additional four year compressor warranty

In addition to the one (1) year warranty stated above, Arctic Air warrants its compressor units to be free from defects in both material and workmanship under normal and proper use and maintenance service for a period of four (4) additional years from the date of original installation but not to exceed five (5) years and three (3) months after shipment from Arctic Air.

The four (4) year extended compressor warranty applies only to the compressor part itself and does not apply to any other parts, components, or labor charges involved in replacement of compressor.

Conditions

All service under this warranty, for either labor or parts, must be performed by a preferred service provider arranged by the Arctic Air warranty Center at 1-855-431-5558. Warranty claims should include model number of the unit, batch and serial number of the unit, and proof of purchase. Service coverage is limited to units located in the United States and Canada only.

Limitations & Exclusive Warranty

This parts and labor warranty is the sole and exclusive warranty remedy offered by Arctic Air. Arctic Air's sole obligation under this warranty is limited to either repair or replacement of parts and is subject to the limitations listed below.

1. Arctic Air will bear no responsibility or liability for any equipment which has been misapplied, mishandled, misused, subjected to harsh chemical action, or external causes such as the use of extension cords, electrical power fluctuations, lack of proper maintenance, non-factory approved revisions or modifications, or equipment damaged by fire, flood, or other acts of God.
2. Arctic Air will bear no responsibility for consequential loss or damages such as, including but not limited to, economic loss, profit loss, personal injury, property damage, damage during transit, losses or damages arising from food or product spoilage claims.
3. Arctic Air shall bear no responsibility for parts or labor coverage for component failure or other damages resulting from improper usage, installation, or maintenance as described in the owner's manual.
4. Exceptions to one (1) year part warranty other than additional four (4) year compressor warranty: Light bulbs and door gaskets are limited to 90 day warranty period.
5. Arctic Air equipment is intended for commercial use only and this warranty is void if the equipment is installed in other than commercial applications.
6. All other warranties, either express or implied, arising under law or equity or custom of the trade, including but not limited to, warranties or merchantability or fitness for a particular purpose are excluded. Arctic Air's liability on any claim, including but not limited to negligence, shall not exceed the price of the equipment that gives rise to the claim.



Broich Enterprises, Inc. / Arctic Air

7550 Market Place Drive

Eden Prairie, MN 55344

Phone: 952-941-2270

Fax: 952-941-3066

Website: www.arcticairco.com