

EPAct 2005 Compliant

This Space for Architect/Engineer Approval

Job Name _____ Date _____
 Model Specified _____ Quantity _____
 Customer/Wholesaler _____
 Contractor _____
 Architect/Engineer _____

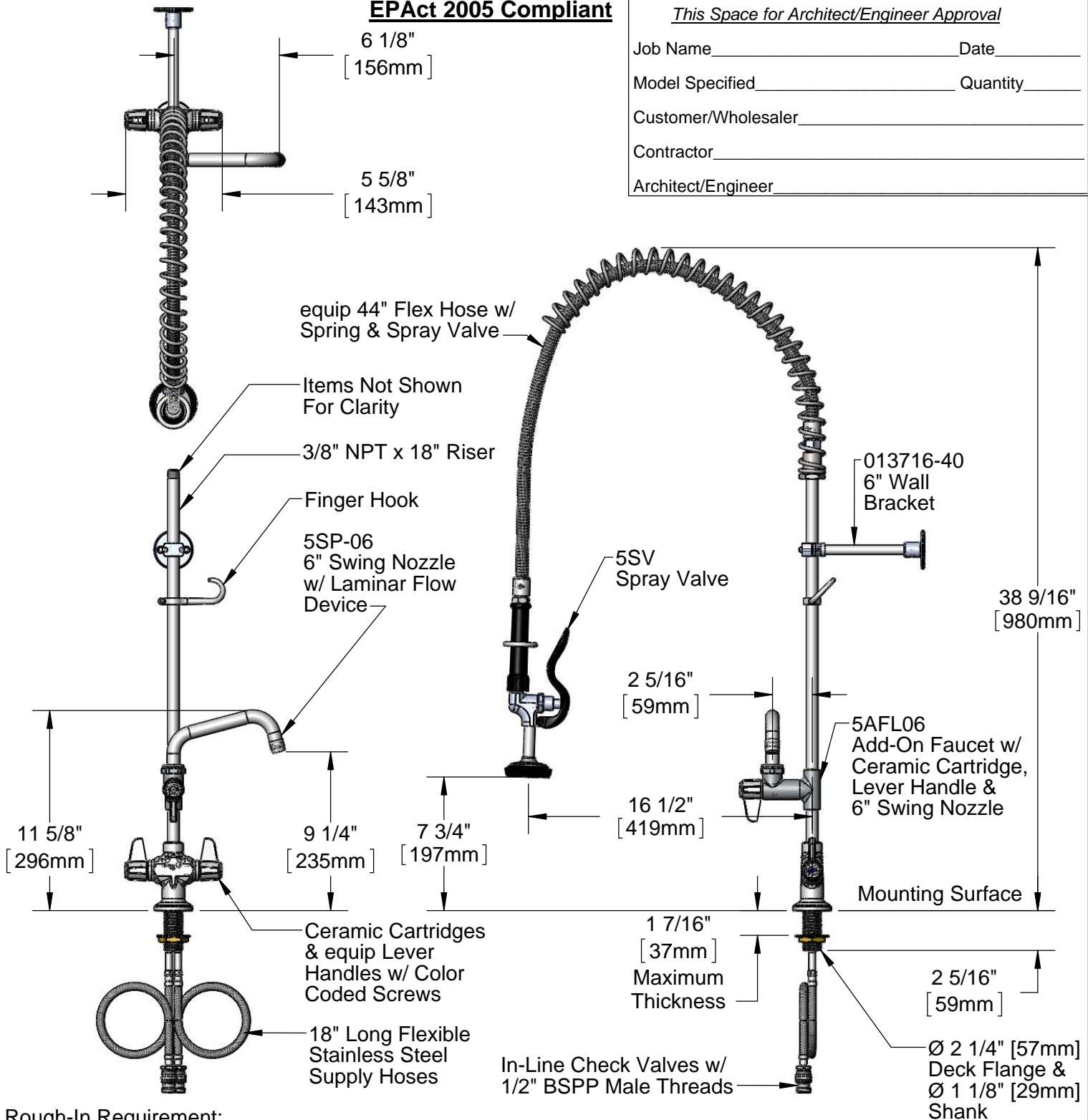

Rough-In Requirement:
 Ø 1 1/2" [Ø38mm] Mounting Hole

Model Number 5PR-2S06	Date 08/08/12	Scale 1:8	Drawn DHL	Checked DMH	Approved JHB
--------------------------	------------------	--------------	--------------	----------------	-----------------

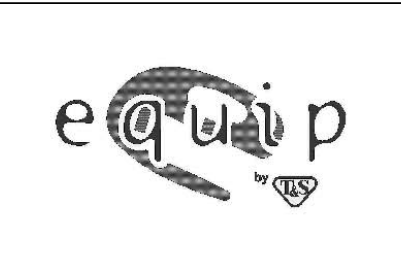

Product Specifications:
Pre-Rinse Unit: Single Hole Deck Mount Mixing Faucet, Ceramic Cartridges, Add-On Faucet w/ 6" Swing Nozzle, 6" Wall Bracket, 5SV Spray Valve, 1/2" BSPP In-Line Check Valves & Flexible Supply Hoses

equip Foodservice Accessories
 2 Saddleback Cove, P.O. Box 1088
 Travelers Rest, South Carolina 29690
 Phone: 800.891.4808 Fax: 800.868.0084

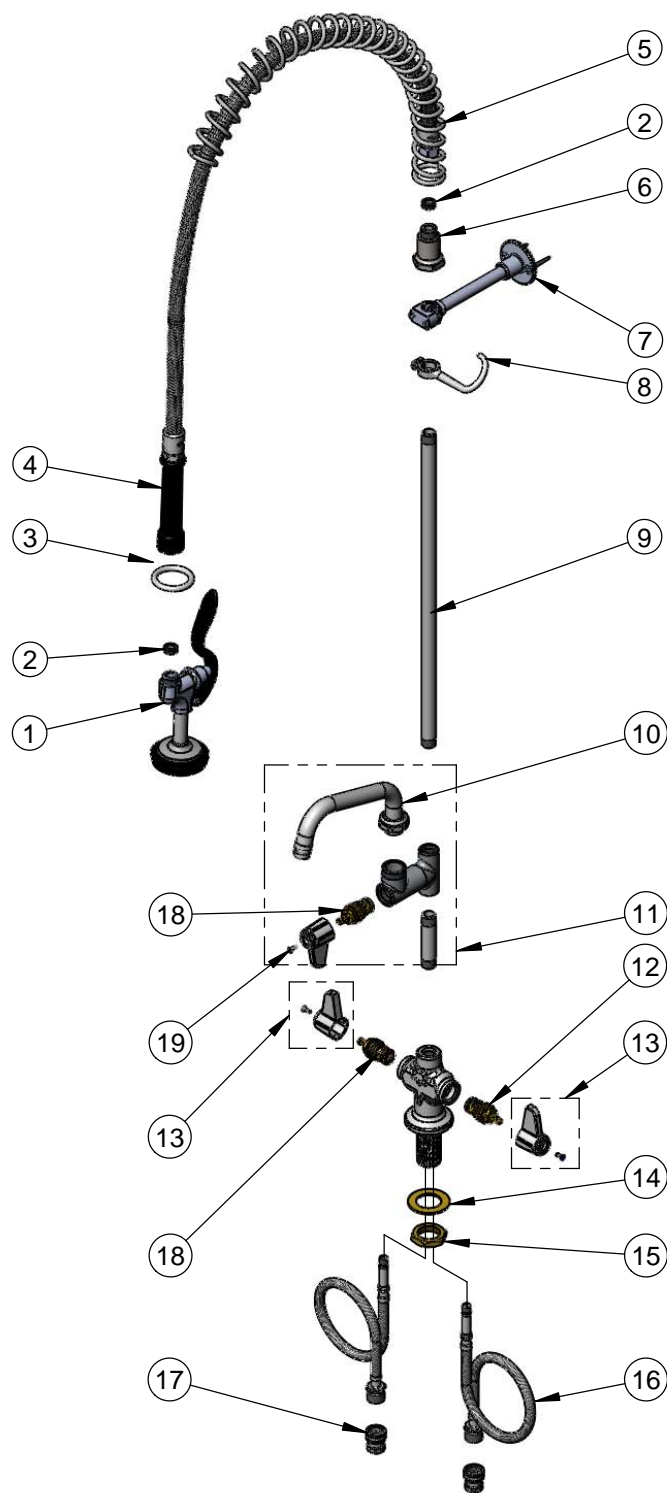

ITEM NO.	SALES NO.	DESCRIPTION
1	5SV	equip Spray Valve
2	010476-45	#27 Washer
3	000907-45	Spray Valve Hold Down Ring
4	5HSE44	equip 44" Flex Hose (Includes Washer)
5	014068-45	Overhead Spring
6	000821-40	Spring Body
7	013716-40	6" Wall Bracket
8	004R	Finger Hook
9	000369-40	3/8" NPT x 18" Long Riser
10	5SP-06	equip 6" Swing Nozzle
11	5AFL06	Add-On Faucet w/ 6" Swing Nozzle
12	013788-45	equip Ceramic Cartridge, LTC
13	5-HDL-L	equip Lever Handle w/ Color Coded Screws
14	002290-45	Lock Washer
15	000965-45	Lock Nut
16	012534-45	Flexible Supply Hose
17	010321-45	1/2" BSPP In-Line Check Valve
18	013787-45	equip Ceramic Cartridge, RTC
19	013849-45	Screw, 4mm Metric (10)

Model Number 5PR-2S06	Date 08/08/12	Scale NTS	Drawn DHL	Checked DMH	Approved JHB
--------------------------	------------------	--------------	--------------	----------------	-----------------



Product Specifications:
Pre-Rinse Unit: Single Hole Deck Mount Mixing Faucet, Ceramic Cartridges, Add-On Faucet w/ 6" Swing Nozzle, 6" Wall Bracket, 5SV Spray Valve, 1/2" BSPP In-Line Check Valves & Flexible Supply Hoses

equip Foodservice Accessories
 2 Saddleback Cove, P.O. Box 1088
 Travelers Rest, South Carolina 29690
 Phone: 800.891.4808 Fax: 800.868.0084