

This Space For Architect/Engineer Approval

Job Name _____ Date _____
 Model Specified _____ Quantity _____
 Customer/Wholesaler _____
 Contractor _____
 Architect/Engineer _____

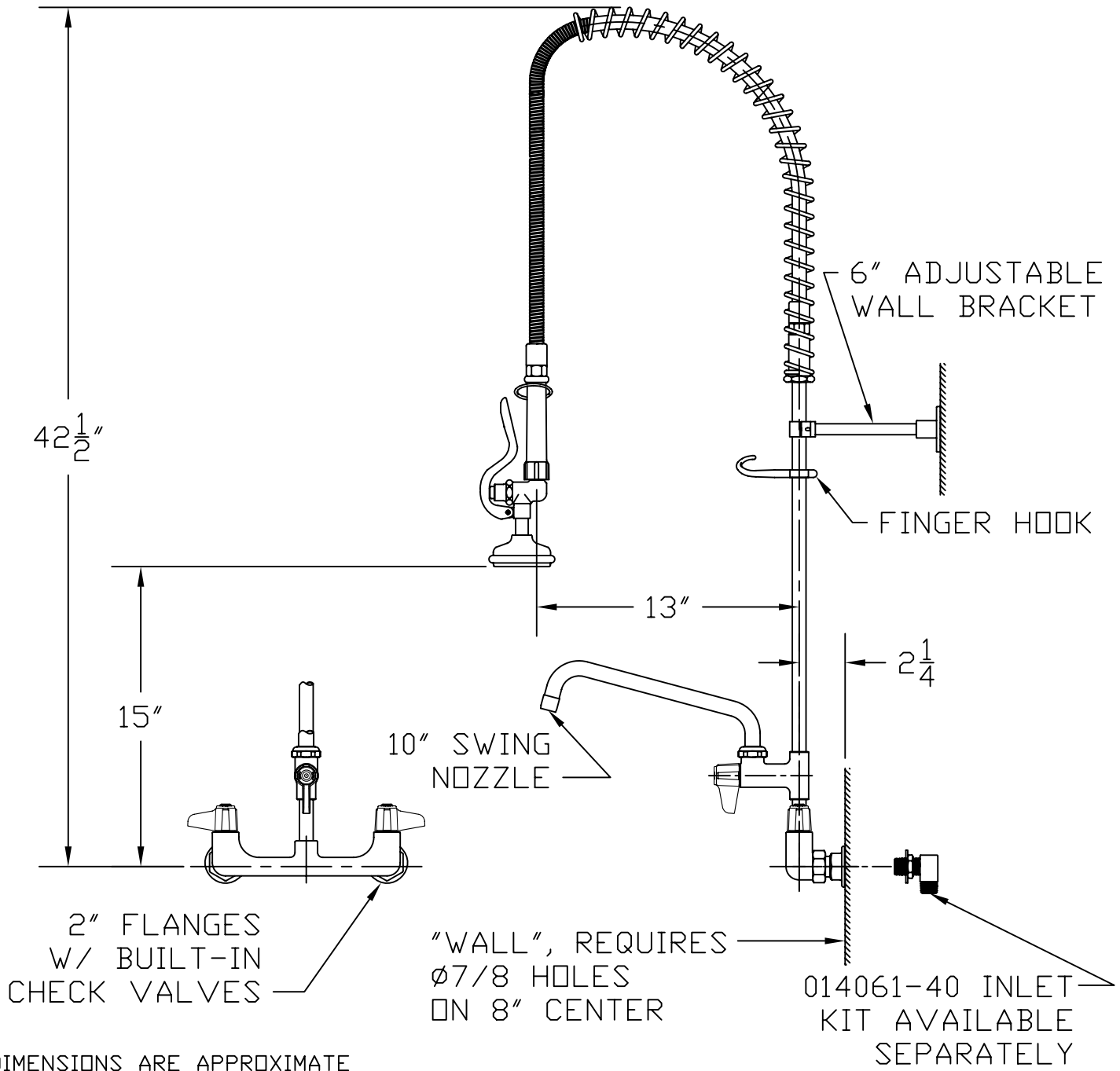

DIMENSIONS ARE APPROXIMATE

MODEL NUMBER 5PR-8W10	DATE 3/21/06	SCALE 1:8	DRAWN DHL	CHECKED WJS	APPROVED JHB
--------------------------	-----------------	--------------	--------------	----------------	-----------------



DESCRIPTION
 8" WALL MOUNT PRU w/ 10" SWING NOZZLE ADD-ON FAUCET

equip Foodservice Accessories
 P.O. BOX 1088, 2 SADDLEBACK COVE
 TRAVELERS REST, SOUTH CAROLINA 29690
 PHONE: 800.891.4808 FAX: 800.868.0084