



T&S BRASS AND BRONZE WORKS, INC.
 2 Saddleback Cove / P.O. Box 1088
 Travelers Rest, SC 29690

Model No.
B-0048-H

Item No.

Travelers Rest, SC: 800-476-4103 • Simi Valley, CA: 800-423-0150 • Fax: 864-834-3518 • www.tsbrass.com

This Space for Architect/Engineer Approval

Job Name _____ Date _____

Model Specified _____ Quantity _____

Customer/Wholesaler _____

Contractor _____

Architect/Engineer _____

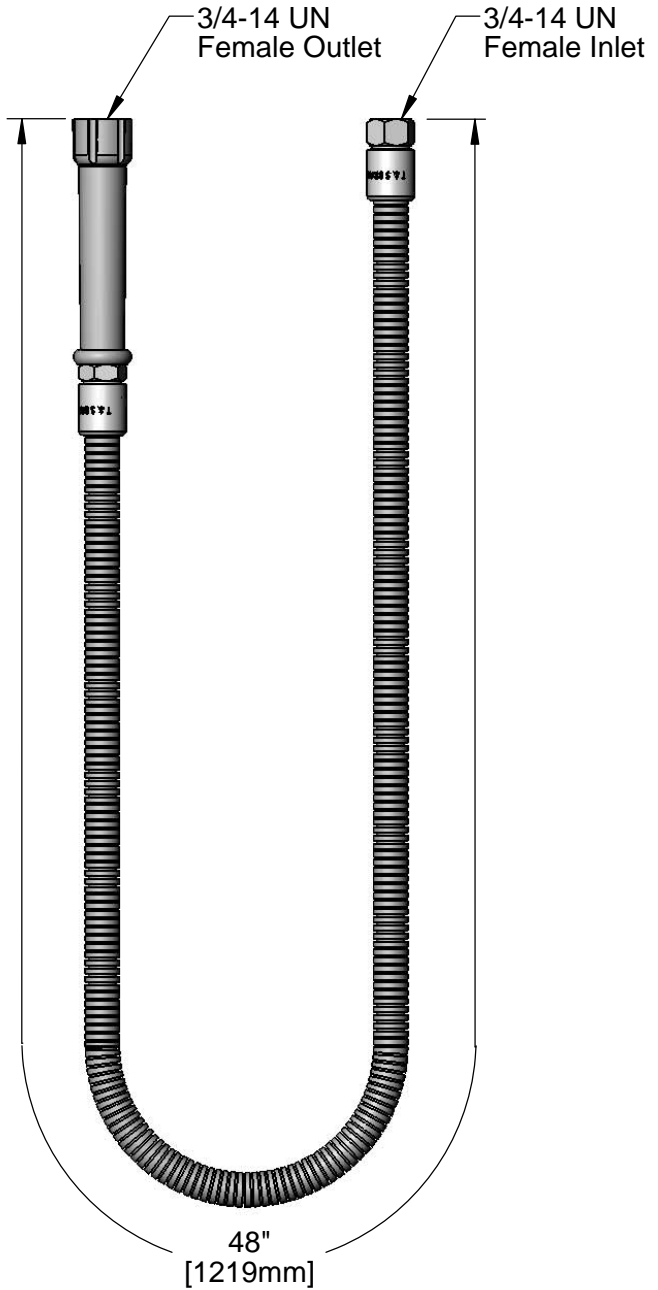

 (2) 010476-45
 Washers
 (Included)

Product Specifications:
 48" Stainless Steel Flex Hose w/
 Gray Handle & Polyurethane Inner Hose

Drawn DHL	Checked DMH	Approved JHB
Scale: 1:4		Date: 08/27/12



T&S BRASS AND BRONZE WORKS, INC.
 2 Saddleback Cove / P.O. Box 1088
 Travelers Rest, SC 29690

Model No.
B-0048-H

Item No.

Travelers Rest, SC: 800-476-4103 • Simi Valley, CA: 800-423-0150 • Fax: 864-834-3518 • www.tsbrass.com

ITEM NO.	SALES NO.	DESCRIPTION
1	001014-45	Washer, B-0100 Hose Barrel
2	002987-40	Gray Grip Handle
3	010476-45	#27 Washer
4	000729-40	Nut, 7/8"-20 Male x 3/4"-14 Female

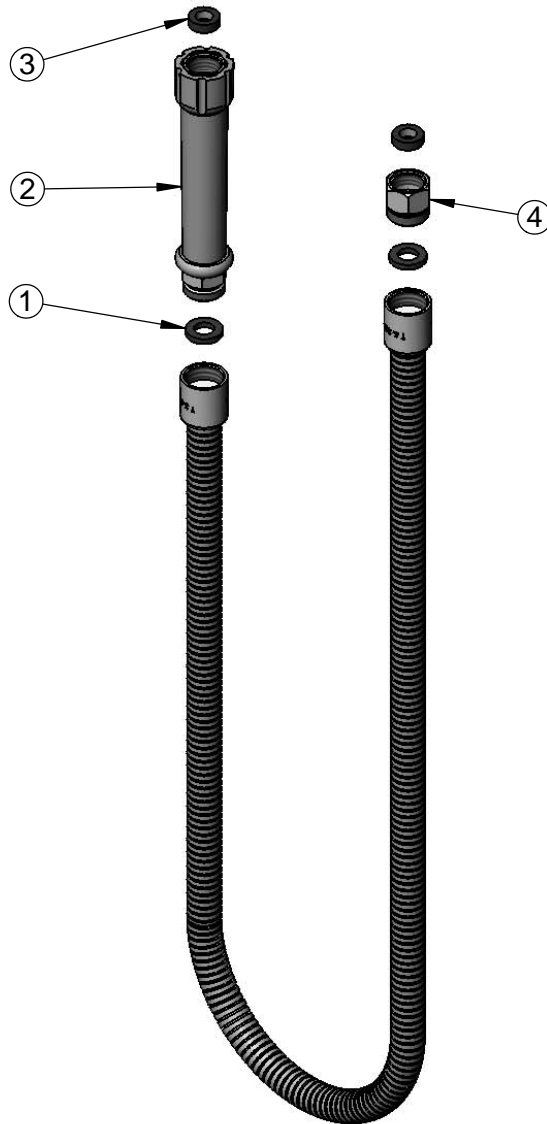

Product Specifications:
 48" Stainless Steel Flex Hose w/
 Gray Handle & Polyurethane Inner Hose

Drawn DHL	Checked DMH	Approved JHB
Scale: NTS		Date: 08/27/12