

Tray and Dish Cart

Cart and Cutlery Rack

Model TDCR12

Cart Only

Model TDC2029

Features & Benefits

- From kitchen to serving line, this cart streamlines self-service operations and provides compact sanitary storage. Holds a variety of plates, trays and cutlery.
- Made of single-molded, seamless, double-wall, high-density polyethylene construction.
- Easy to clean and impact resistant. Won't rust, peel, crack or dent.
- Foamed-in polyurethane insulation adds structural strength and reduces noise.
- Rounded corners protect walls.
- Available with or without detachable 12-Compartment Cutlery Rack CR12.
- Includes 12 flatware cylinders.
- Molded-in handles on both sides ensure easy & comfortable handling.
- Four 6" (15,2 cm) swivel casters, 2 w/ brakes, provide easy maneuvering.
- Convenient vinyl cover included for added protection and more sanitary storage. Cover is not NSF listed.
- No assembly required.
- Available in 6 colors.

Item No. _____

Specifier Identification No. _____

Model No. _____

Quantity _____



TDCR12



TDC2029

Approvals



Tray and Dish Cart

Cart and Cutlery Rack

Model TDCR12

Cart Only

Model TDC2029

Item No. _____

Specifier Identification No. _____

Model No. _____

Quantity _____

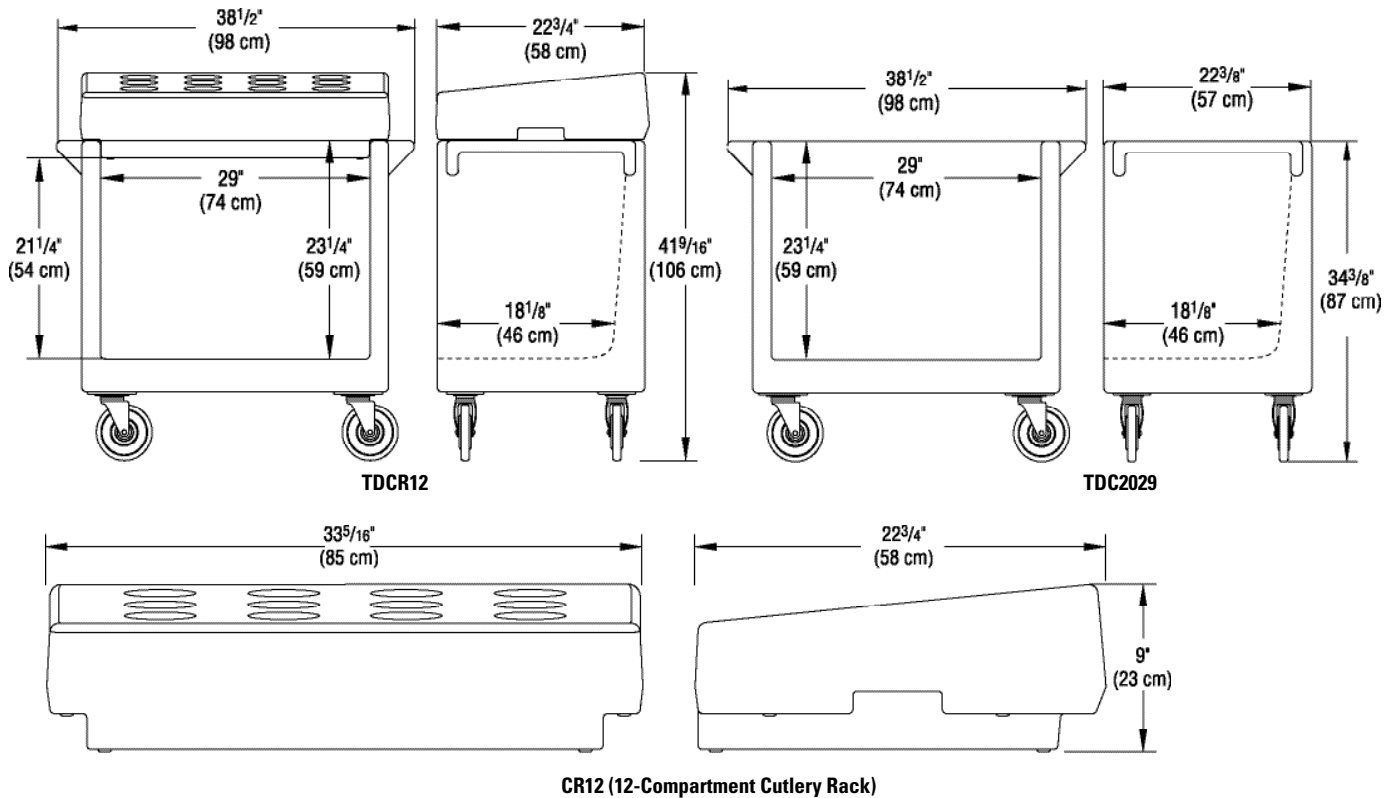

CR12 (12-Compartment Cutlery Rack)

Specifications

Dimension Tolerance: +/- 1/4" (0,64 cm)

Code	Description	Exterior Dimensions W x D x H	Case lbs./cube Kg/m ³
TDCR12	Cart & Cutlery Rack Combination	38 1/2" x 22 3/4" x 41 9/16" (98 x 58 x 106 cm)	88,5 (22,23) 40,5 (0,63)
TDC2029	Cart only	38 1/2" x 22 3/4" x 34 3/8" (98 x 57 x 87 cm)	65 (18,80) 29,5 (0,3)

Optional Accessories

12-Compartment Cutlery Rack CR12
W x D x H 33 5/16" x 22 3/4" x 9" (85 x 58 x 23 cm)

Replacement Vinyl Cover RDC2029C (1 included with cart)

*Note: Vinyl Cover is not NSF listed.

Standard Colors

- Slate Blue (401) Dark Brown (131) Coffee Beige (157)
 Gray (180) Granite Green (192) Granite Gray (191)

Architect Specs

The Tray and Dish Cart shall be Cambro Model..., manufactured by Cambro Mfg. Co., Huntington Beach, CA 92648 U.S.A. It shall be single-molded, seamless, double-wall, high density polyethylene and foam injected polyurethane. It shall have rounded corners and molded-in handles. It shall have four each 6" (15,2 cm) swivel casters, 2 w/ brakes, mounted on molded-in impact plates. It shall have a detachable 12-compartment Cutlery Rack. It shall have a vinyl cover included for added protection and sanitary storage and shall be available in 6 colors.

Approvals

