

## MOBILE WORK STANDS 278 SERIES

### FEATURES AND BENEFITS:

- Versatile mobile work stand can be used as a self-contained work center or station for small appliances.
- Two styles available:  
Open top model has provision for holding a pan and cutting board; outrigger adapters allow for addition of one pan on each side - Model 278-PT-1818.  
Solid top model features side drop shelves with snap-lock system - Model 278-PT-1818-DS.
- Use of outrigger adapters or drop shelves increases work surface to approximately 5 feet.
- Fully welded framework of structural aluminum extrusions for rigidity and durability.
- Constructed of non-corrosive, Hi-Tensile aluminum for strength.
- Corrugated sidewalls securely hold 18" x 26" pans on 1-1/2" centers without tipping. Provides added strength.
- Offers complete flexibility for operator's selection of pan spacing. Eliminates potential of product damage.
- Heavy duty 5" swivel casters, two with brakes. Provides mobility when fully loaded.



278-PT-1818-DS



278-PT-1818



### ACCESSORIES and OPTIONS (Available at extra cost):

- Slicer Support Kit (for model 278-PT-1818)
- Stainless Steel Top and/or Shelves (for model 278-PT-1818-DS)
- Cutting Board and Pan Assembly
- Pan Stop
- Corner Bumpers
- Vertical Corner Bumpers (for model 278-PT-1818)
- Perimeter Bumper
- Rotary Bumpers (for use with 5" casters)
- Floor Lock (for use with 5" casters)
- Various Caster Options

See page G-36 for accessory details.

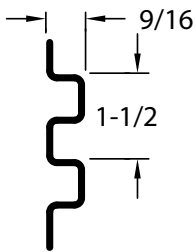

DETAIL OF PAN SLIDE

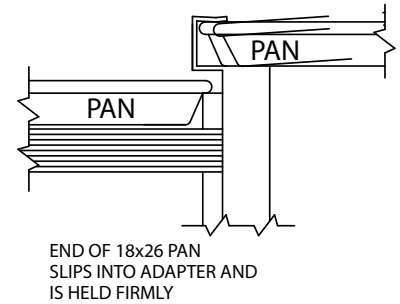
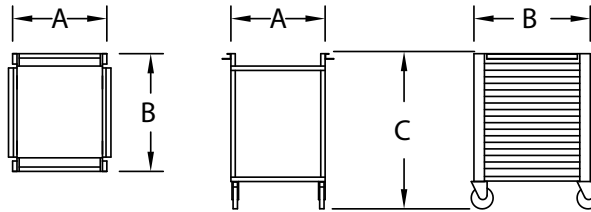

CRES COR MODEL NO.	PAN			DIM "A"	DIM "B"	DIM "C"	INSIDE DIMENSIONS			WEIGHT ACT.	
	CAP	SIZE		WIDTH*	DEPTH	HEIGHT	WIDTH	DEPTH	HEIGHT		
278-PT-1818	18	18 X 26	IN	21-7/8	26-3/4	36	18-1/16	26	26-3/8	LBS	42
		460 X 660	MM	560	680	915	460	660	670	KG	19
278-PT-1818-DS	18	18 x 26	IN	23-1/2	26-3/4	36	18-1/16	26	26-3/8	LBS	62
		460 x 660	MM	600	680	915	460	660	670	KG	28

- NOTES: 1. \*Add 32" (815 mm) to width when trays are mounted to sides or shelves are extended.  
 2. Send sample pan or tray with order when using any that are not 18" x 26" pans with heavy beaded edges.  
 3. When ordering bumpers, add 2" to overall dimensions.

ALL ALUMINUM CONSTRUCTION IS RIVETED, WELDED AND FINISHED.

**RACK:**

- Posts: Extruded channels, 1 x 2 x .125.
- Top and bottom: Extruded channels, 1-1/16 x 2-3/8 x .188; welded to posts.
- Sides: .063 aluminum corrugations riveted to posts.
- Casters: 5" dia., swivel, modulus tires, 1-1/4 wide, load cap. 250 lbs. each, temp. range -45°/+180°F. Delrin bearings. Two casters equipped with brakes.

**278-PT-1818:**

- Outrigger adapters (2): Formed .100 aluminum channels; one each side welded to posts.

**278-PT-1818-DS:**

- Top: Formed .063 aluminum.
- Drop shelves: Formed .063 aluminum hinged to top; riveted to .100 aluminum supports. Push button release drops the shelves.
- Optional stainless steel drop shelves and top are 18 ga. type 304.

**PAN SLIDES:**

- Corrugations act as pan slides on 1-1/2" centers.

**SHORT FORM SPECIFICATIONS**

Cres Cor Mobile Work Stand Model 278-PT-\_\_\_\_\_. Extruded aluminum welded construction. No-tip corrugated sides for (18) 18" x 26" pans on 1-1/2" centers. 5" swivel modulus casters, Delrin bearings. Load capacity 250 lbs. each, temperature -45° to +180°F.  
 278-PT-1818: With outrigger adapters.  
 278-PT-1818-DS: With solid aluminum top and drop shelves.  
 2-Year Parts / 1-Year Labor warranty. Provide the following accessories: \_\_\_\_\_. NSF Listed.



5925 Heisley Road • Mentor, OH 44060-1833  
 Phone: 877/CRESCOR • Fax: 440/350-7267  
 www.crescor.com

© Crescent Metal Products, Inc. 2016 All rights reserved.

*In line with its policy to continually improve its products, CRES COR reserves the right to change materials and specifications without notice.*

Litho in U.S.A.