

Dutchess

Bakers' Machinery Company, Inc.

A subsidiary of Superior-Lidgerwood-Mundy Corp.

*A United States of America Manufacturer
Since 1886*

Item No. _____

Model 270

French Bread/Bun & Bagel Slicer



Electrically Operated Slicer

For slicing French Bread, Bagels, Subs, Hamburger Buns, Coney Buns, Hoagies, Biscuits, Bread Sticks and much more.

Adjustable for product size up to 6" (152.4 mm) wide by 3" (76.2mm) thick.

Can slice all the way through on product up to 5-1/4" (133.3 mm) wide or hinged product up to 6" (152.4 mm) wide.

Will slice as fast as the operator can feed the product into the chute.

Simple to operate - Adjustments are fast, easy to set, repeatable and accurate.

Chute can be removed without tools for safe, easy cleaning without interference from the cutting blade.

Great for use in Supermarkets, Bakeries, Schools, Deli's, Retail Bakeries, Sub Shops, Hospitals, Restaurants, Bagel Shops, Caterers and more!

Two year Warranty.

Manually operated Blade Brake standard.



NSF (NSF International)



UL (Underwriters Laboratories)

ASSOCIATE MEMBER
MAFSI
Manufacturers' Agents for
the Food Service Industry

Dutchess Bakers' Machinery Co.
302 Grand Avenue, PO Box 39
Superior, WI 54880

ISO 9000:2001 COMPLIANT

Toll Free: 800-777-4498
Phone: 715-394-4444
Fax: 715-394-2406
sales@dutchessbakers.com
www.dutchessbakers.com

Model 270 French Bread/Bun & Bagel Slicer

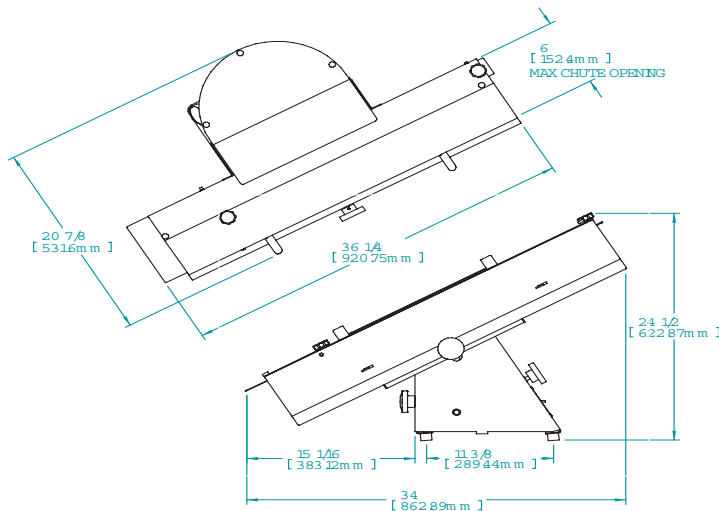

Complete Cut:

Maximum: 5-1/4" (13.33 cm)

From Bottom: 1/2" to 1-1/2"
(1.27 - 38.1 cm)

Adjustable for hinged cut on product up to:

6" wide and 3" thick
(15.24 cm wide and 76.2 cm thick)

Machine Dimensions:

Standard Chute Width: variable 18 - 20-7/8" (45.72 - 53.16 cm)

Length: 34" (86.36 cm) **Height:** 24-1/2" (62.23 cm)

Shipping Wt.: 102 lbs.(46.2 kg) **Net Wt.:** 75 lbs (34 kg)

Shipping Dimensions: 36 wide x 21 deep" x 30" (91.44 cm x 53.34 cm x 76.2 cm)

Electrical requirements:

Standard: (Model M-270) 115v / 60hz / 1-phase, 1/2hp Motor, 1725 rpm, 8.7 amps
On/Off Switch with built-in Overload Protection.

Optional: (Model M-270E) 220-240v / 50hz / 1-phase, 1/2 hp Motor, 1425 rpm, 4.8 amps

Standard: White Powder Coated Finish (*non-food contact*) **Stainless Steel** (*food contact*)
Options: Extra Cutting Blades (P/N A4-037-0003)

Dutchess Bakers' Machinery Company Inc., 302 Grand Avenue, Superior, WI 54880-0039

Toll Free: 800-777-4498 ~ Ph: 715-394-4444 ~ Fax: 715-394-2406

sales@dutchessbakers.com ~ www.dutchessbakers.com