

# Open Hearth Radiant Heat

Gas Char-Broiler with FLARETROL<sup>®</sup>



★ MADE in the USA ★



EmberGlo<sup>®</sup>



# Open Hearth Radiant Heat

## Gas Char-Broilers with FLARETROL®



★ MADE in the USA ★

### EmberGlo® Gas Broilers Cook with Extreme Radiant Heat!

Now you can enjoy the flavor of outdoor charbroiling —indoors! EmberGlo's eye-catching glowing hearth will reach a temperature over 1600° searing your meats yet preserving the natural flavor. With our unique FLARETROL® system, you have perfect control to keep flare ups where they belong—low and concentrated for best cooking results.

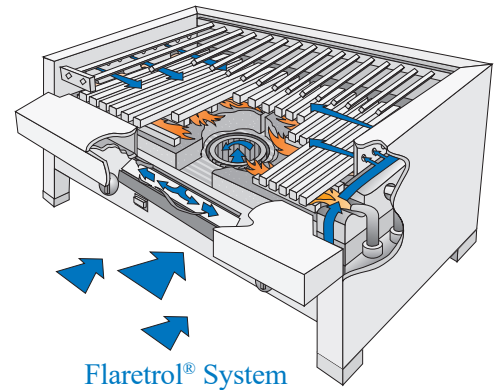

Open Hearth Open Front Gas Broiler - Floor Model 25F

Models 25C and 25F - Side  
25C Kabob and 25F Kabob

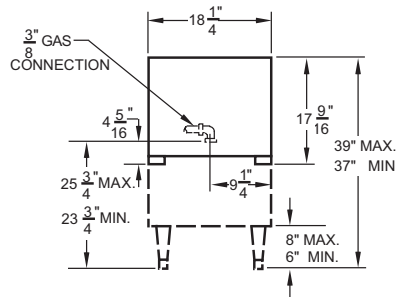

### Unmatchable Outdoor flavor with indoor ease—EmberGlo®

EmberGlo's design has made open hearth broiling practical, economical and profitable for every type of food service operation. Our special in shot gas burners supply broiling heat to a durable ceramic hearth. The BARBRIQ transmit searing radiant heat to the meat utilizing its natural juices and creating more natural fuel. Burner jets are located along the sides of the recessed hearth instead of below it. This design helps prevent the jets from becoming clogged with dripping grease, ashes, soot or food particles.

Models 25C and 25F - Front  
25C Kabob and 25F Kabob



Open Hearth Open Front Gas Broiler - Counter Model 25C

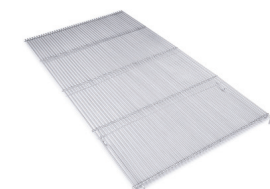
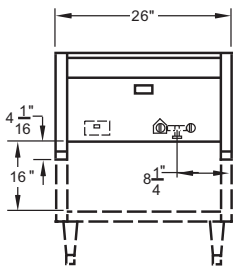

Veggie Seafood Grill  
2070702 - FG1 - Model 25  
2070700 - FG2 - Model 31  
2070701 - FG3 - Model 41



Skewers - Set of 10  
Stainless Steel  
Kabob 25 Char-Broiler 4508-68  
Kabob 31 Char-Broiler 4508-69

### Broiler Accessories

Casters  
Set of 4  
2070100



Gas Broiler Grill Brush  
1420-39

Splash Guards - Stainless Steel  
Dishwasher Safe for use on  
Models 25W only  
Set of 2 Sides & 1 Back  
2060130

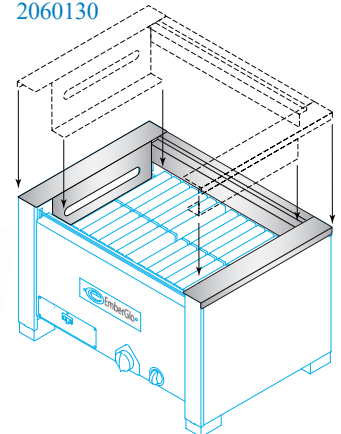

Models 31C and 31F  
31C Kabob and 31F Kabob  
(with optional work shelf measurements)



Open Hearth Open Front  
Gas Broiler - Floor  
Model 41F

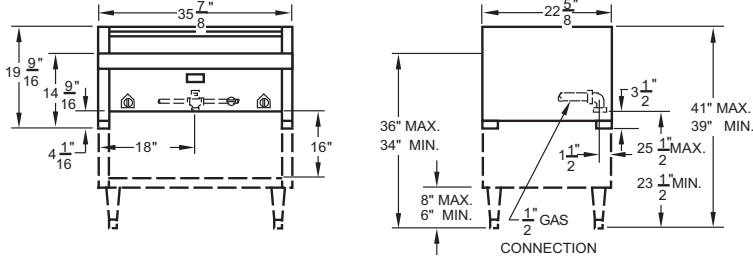

Models 41C and 41F  
(with optional work shelf measurements)

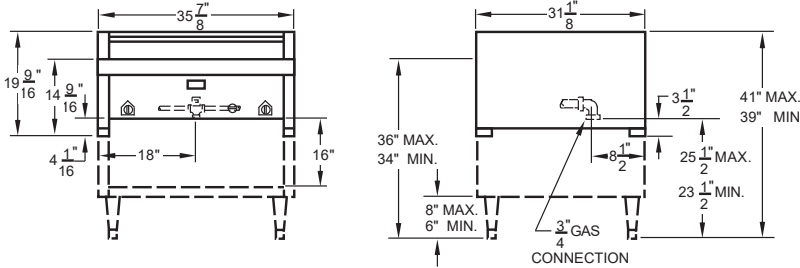

Optional Features

Models 31 and 41

- Work Shelves - Multiple Configurations Available

Floor Models

- Casters



All Models

- Stainless Steel Sides (full)
- Accessory Veggie Seafood Grill

Features

- Ceramic Hearth
- Radiant Heat Cooking
- Unique FLARETROL® System
- Easy Maintenance and Operation
- Self-cleaning Hearth
- No Messy Grease Tray(s)
- Versatile Hearth Set-up of Ceramic BARBRIQ
- Zero Recovery Time for High Volume Broiling
- Rigid, Durable Construction
- 7 Gas Models—counter or floor types
- Available in Natural or Propane Gas



Kabob Char- Broiler  
Open Hearth Open Front  
Model 25WC Kabob

(Kabob Broilers includes a set of 10 Skewers)

All standard models include black enamel sides with stainless trim, and a choice of mid or open front. The 25W & 31N are the exceptions, which are completely constructed in stainless steel.

Standard floor models have an open base with stainless storage shelf.

Models 25WC Kabob and 25WF Kabob

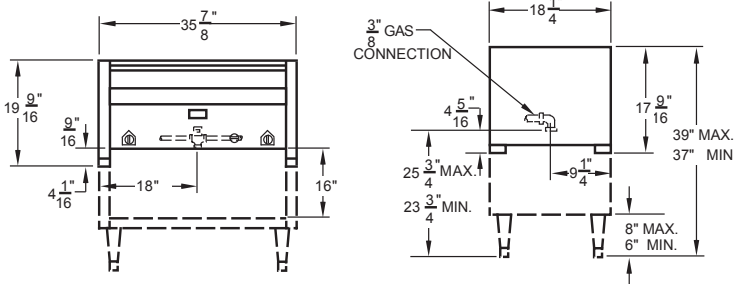

Kabob Char- Broiler  
Open Hearth Mid Front  
Model 31F Kabob

(Kabob Broilers includes a set of 10 Skewers)

Models 31NC and 31NF

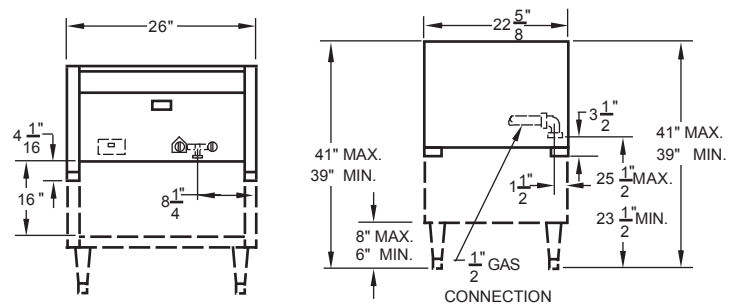



# Specifications - Char-Broilers

Model Number	Cabinet Size	Grill Sq. Inch	Grill Size	Max Btu/Hr Input	Flaretrol Amperage	Number of Burners / Btu for Each Burner	Shipping Weight
25C	26"w X 18 1/4"d X 17 9/16"h	333	21 3/8"w X 15 5/8"d	39,600	120V,60Hz, 1.5 amp	4 6,600 Btu/burner	190 lbs
25F	26"w X 18 1/4"d X 37 to 39"h						250 lbs
25C Kabob *	26"w X 18 1/4"d X 17 9/16"h	333	21 3/8"w X 15 5/8"d	39,600	120V,60Hz, 1.5 amp	4 6,600 Btu/burner	190 lbs
25F Kabob *	26"w X 18 1/4"d X 37 to 39"h						250 lbs
25WC Kabob *	35 7/8"w X 18 1/4"d X 19 1/2"h	480	30 3/4"w X 15 5/8"d	43,400	120V,60Hz, 1.5 amp	2 @ 6,600Btu/burner 4 @ 8,500Btu/burner	240 lbs
25WF Kabob *	35 7/8"w X 18 1/4"d X 40"h						305 lbs
31C	35 7/8"w X 22 5/8"d X 19 9/16"h	657	30 3/4"w X 21 3/8"d	68,000	120V,60Hz, 1.5 amp	8 8,500 Btu/burner	310 lbs
31F	35 7/8"w X 22 5/8"d X 41"h						400 lbs
31C Kabob *	35 7/8"w X 22 5/8"d X 19 9/16"h	657	30 3/4"w X 21 3/8"d	68,000	120V,60Hz, 1.5 amp	8 8,500 Btu/burner	310 lbs
31F Kabob *	35 7/8"w X 22 5/8"d X 41"h						400 lbs
31NC	26"w X 22 5/8"d X 19 9/16"h	427	21 3/8"w X 21 3/8"d	60,400	120V,60Hz, 1.5 amp	8 7,550 Btu/burner	248 lbs
31NF	26"w X 22 5/8"d X 40"h						315 lbs
41C	35 7/8"w X 31 1/8"d X 19 9/16"h	427	30 3/4"w X 29 3/8"d	85,000	120V,60Hz, 1.5 amp	10 8,500 Btu/burner	415 lbs
41F	35 7/8"w X 31 1/8"d X 41"h						490 lbs

*Experienced chefs know that it is the radiant heat, not the flame, that cooks food and seals in flavor. Controlled radiant heat, applied properly, is the key to perfectly broiled, mouth-watering dishes. Our exclusive FLARETROL® system is the most effective means of flare up control for open hearth broiling. When flames are leaping too high, a simple flip of the switch activates the FLARETROL® system. A focused stream of air blows the glowing briquettes, harnessing the flames back to a safe level, while giving back complete control for a consistent unsurpassed broiling technique.*

- All floor and counter models are identical except the addition of a floor stand on "F" models
- \* Kabob broilers come with a set of skewers and the grill grate is optional
- Specify natural or propane gas when ordering

★ MADE in the USA ★

Quality Designed for Proven Performance



As an ISO 9001:2008 certified company, we proudly design, manufacture and assemble our products in Chicago, Illinois, USA.



EmberGlo - A Division of Midco International - 4140 West Victoria Street - Chicago, Illinois 60646

toll free: 866 705 0515 - tel: 773.604.8700 - fax: 773.604.4070 - web: www.emberglo.com - e-mail: sales@emberglo.com



416  
8474 55  
Printed in USA