



HOT BEVERAGE EQUIPMENT

CENTER OF ALL YOUR FOOD SERVICE NEEDS

10L HOT CHOCOLATE DISPENSER

Item #: 31840

Model: DI-CN-0010

*Elegantly designed
Hot Chocolate Dispenser*



Authorized Dealer

HOT BEVERAGE EQUIPMENT

10L HOT CHOCOLATE DISPENSER



Detail Shots

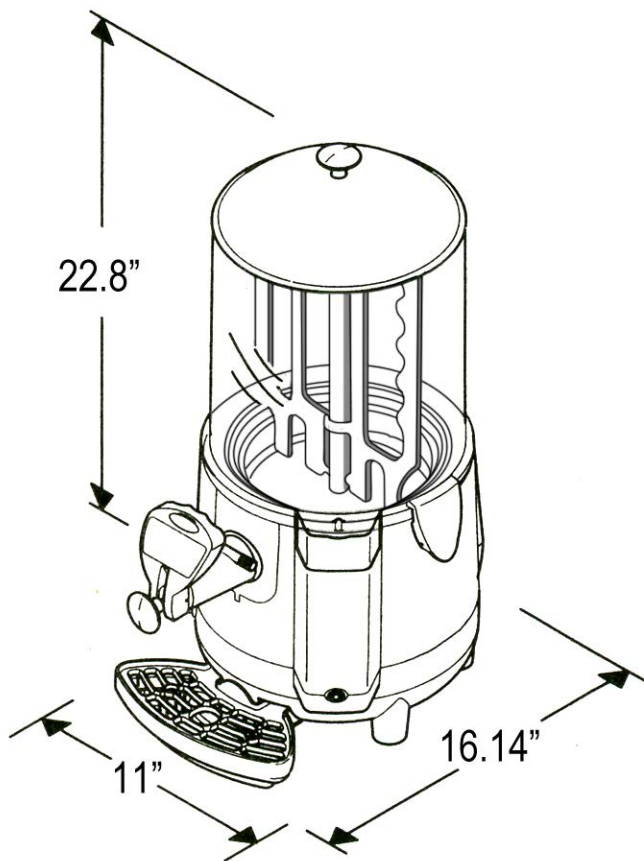

Ideal for a variety of drinks like hot chocolate, coffee, milk or mulled wine.

Features:

- Bain-marie heating system with a wide controlled range of temperature +30°C to +100°.
- Thermostat for adjusting as required.
- Continuous stirring maintains a perfect, lump-free consistency.
- Special anti-clogging faucet.
- Interior lighting.
- Self-closing doors.
- Casters.
- Lock mounted.
- #304 Stainless Steel boiler with thermal protector.
- Polyurethane insulation.

PRODUCT SPECIFICATIONS

ITEM NUMBER	39482	DIMENSIONS	16.14" x 11" x 22.8"
MODEL	DI-CN-0010	PACKAGING DIMENSIONS	15" X 15" X 26"
CAPACITY	10 Litre	NET WEIGHT	16.5 lbs.
POWER	1000 Watts	PACKAGING WEIGHT	21 lbs.

OMCAN INC.

Mississauga, Ontario, Canada
Laval, Quebec, Canada
Niagara Falls, New York, USA

1-800-465-0234 | WWW.OMCAN.COM



Follow us to keep up to date with the latest news and offers

