

Project: _____	AIA# _____
Item #: _____ Qty: _____	SIS# _____
Model #: _____	

Wall-Hung Hand Sinks

see reverse side for model numbers



★ All faucets are NSF/ANSI 61, Annex G low lead compliant

Standard Features

- Manufactured with total welded construction to meet all NSF® standards
- All stainless steel construction
- 9-1/4" by 11-1/2" by 6" deep sink bowl
- Includes wall mounting bracket
- Includes 1-1/2" IPS drain fitting
- Heavy-duty faucet is standard (available less faucet by adding the suffix '-LF' to the model number)
- Left and right side splashes available as an accessory
- Model WH-12 and WHS-12 include a special backsplash faucet mounting bracket for easy removal and inspection of faucet after installation
- Models WH-14-S and WHS-14-S include integral left and right side splashes, featuring radius worksurface corners for easy cleaning and a front lip to contain splashes
- Model WDH-14 includes built-in soap and C-fold paper towel dispensers
- Model WH-14-ESD includes a 1" deep recessed work surface with extra tall backsplash to contain splashes, and soap and papertowel dispenser

Specifications

Drains

- 1-1/2" I.P.S. Threaded drain will fit Dearborn part #8033 slipnut and part #W-573P washer.

Faucet

- Deck mount on 4" centers, accepts 3/8" sink leads, hot and cold water connections required (except model WH-12 and WHS-12)
- Model WH-12 and WHS-12: Backsplash mounted on 4" centers, accepts 3/8" sink leads, hot and cold water connections required

Sink Bowl Dimensions

- 9-1/4" by 11-1/2" by 6" deep

Materials

- 20 gauge stainless steel parts include: all components unless otherwise noted
- 18 gauge stainless steel parts include: wall mounting bracket



Model WHS-14-S featuring integral side splashes, radius worksurface corners for easy cleaning and a front lip to contain splashes

Glastender, Inc. • 5400 North Michigan Road • Saginaw, MI • 48604-9780 989.752.4275 • 800.748.0423 • Fax 989.752.4444 www.glastender.com	Approval/Notes:
Specifications subject to change without notice. For current specifications please visit our website.	

Wall-Hung Hand Sinks

Dimensional Information

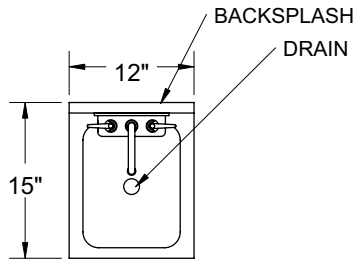

PLAN VIEW
(all 12" models)

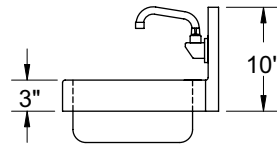

WH-12
SIDE VIEW

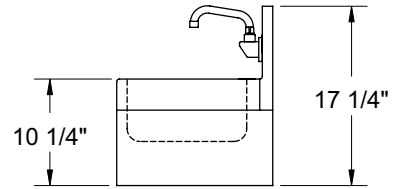

WHS-12
SIDE VIEW

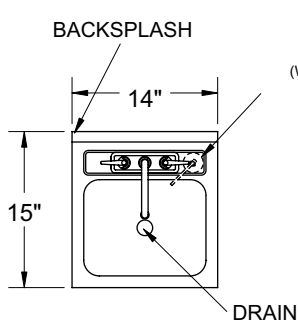

PLAN VIEW
(all 14" models)

LIQUID SOAP
DISPENSER
(WDH-14 and WDH-14-ESD)

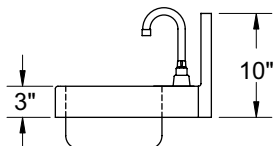

WH-14
SIDE VIEW

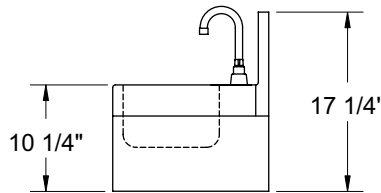

WHS-14
SIDE VIEW

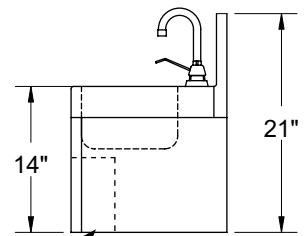

PAPER TOWEL
DISPENSER
WDH-14
SIDE VIEW

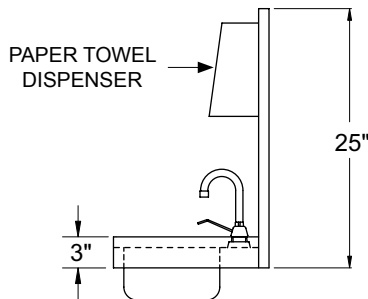

WH-14-ESD
SIDE VIEW

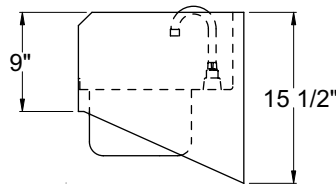

WH-14-S
SIDE VIEW

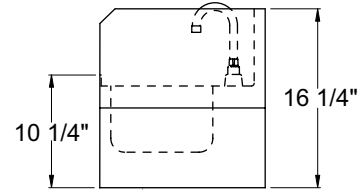

WHS-14-S
SIDE VIEW

WALL MOUNTING INSTRUCTIONS

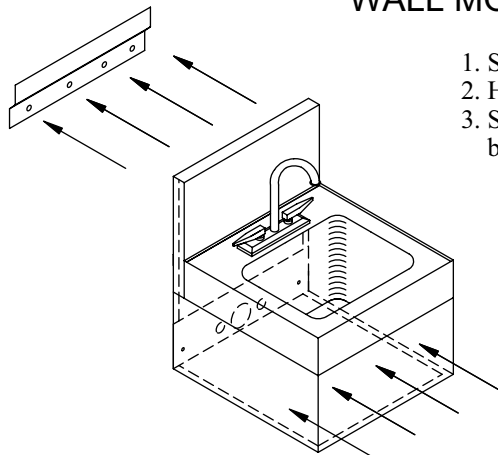

1. Secure bracket to wall.
2. Hang sink on bracket.
3. Screw sink to wall through bracket on bottom back of sink.