

Project: _____	AIA# _____
Item #: _____ Qty: _____	SIS# _____
Model #: _____	

## Wall-Hung Hand Sinks

see reverse side for model numbers



### Standard Features

- Manufactured with total welded construction to meet all NSF® standards
- All stainless steel construction
- 9-1/4" by 11-1/2" by 6" deep sink bowl
- Includes wall mounting bracket
- Includes 1-1/2" IPS drain fitting
- Heavy-duty faucet is standard (available less faucet by adding the suffix '-LF' to the model number)
- Left and right side splashes available as an accessory
- Model WH-12 and WHS-12 include a special backplash faucet mounting bracket for easy removal and inspection of faucet after installation
- Models WH-14-S and WHS-14-S include integral left and right side splashes, featuring radius worksurface corners for easy cleaning and a front lip to contain splashes
- Model WDH-14 includes built-in soap and C-fold paper towel dispensers
- Model WH-14-ESD includes a 1" deep recessed work surface with extra tall backplash to contain splashes, and soap and papertowel dispenser

All faucets are certified low lead compliant

### Specifications

#### Drains

- 1-1/2" I.P.S. Threaded drain will fit Dearborn part #8033 slipnut and part #W-573P washer.

#### Faucet

- Deck mount on 4" centers, accepts 3/8" sink leads, hot and cold water connections required (except model WH-12 and WHS-12)
- Model WH-12 and WHS-12: Backsplash mounted on 4" centers, accepts 3/8" sink leads, hot and cold water connections required
- NSF/ANSI 61, 372 low lead compliant

#### Sink Bowl Dimensions

- 9-1/4" by 11-1/2" by 6" deep

#### Materials

- 20 gauge stainless steel parts include: all components unless otherwise noted
- 18 gauge stainless steel parts include: wall mounting bracket



Model WHS-14-S featuring integral side splashes, radius worksurface corners for easy cleaning and a front lip to contain splashes



**Intertek**  
4004503

Conforms to NSF/ANSI STD 2

WH-14-S, WHS-12, WDH-14  
Certified to CSA STD B45.4

To view cleaning and care instructions, please visit:  
[http://www.glastender.com/PDF/F-423-011\\_ss\\_clean\\_care.pdf](http://www.glastender.com/PDF/F-423-011_ss_clean_care.pdf)

<b>Glastender, Inc.</b> • 5400 North Michigan Road • Saginaw, MI • 48604-9780 989.752.4275 • 800.748.0423 • Fax 989.752.4444 <a href="http://www.glastender.com">www.glastender.com</a>	Approval/Notes:
Specifications subject to change without notice. For current specifications please visit our website.	

# Wall-Hung Hand Sinks

## Dimensional Information

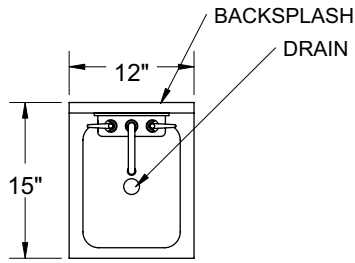

PLAN VIEW  
(all 12" models)

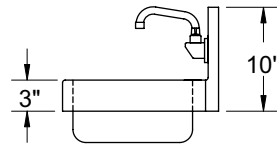

WH-12  
SIDE VIEW

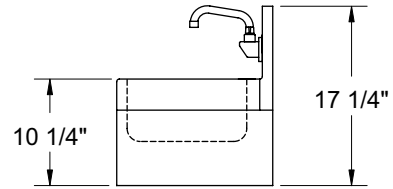

WHS-12  
SIDE VIEW

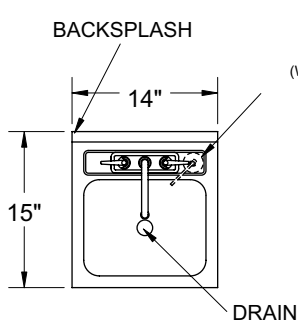

PLAN VIEW  
(all 14" models)

LIQUID SOAP  
DISPENSER  
(WDH-14 and WDH-14-ESD)

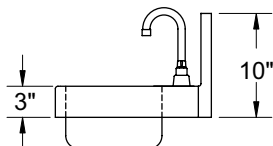

WH-14  
SIDE VIEW

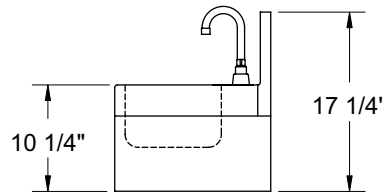

WHS-14  
SIDE VIEW

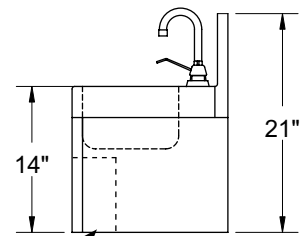

PAPER TOWEL  
DISPENSER  
WDH-14  
SIDE VIEW

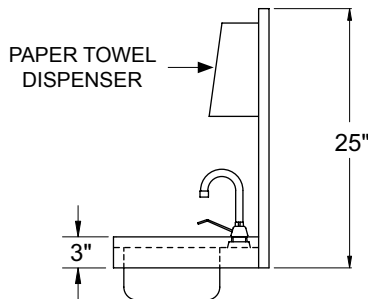

WH-14-ESD  
SIDE VIEW

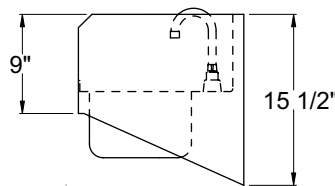

WH-14-S  
SIDE VIEW

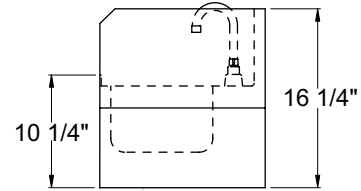

WHS-14-S  
SIDE VIEW

## WALL MOUNTING INSTRUCTIONS

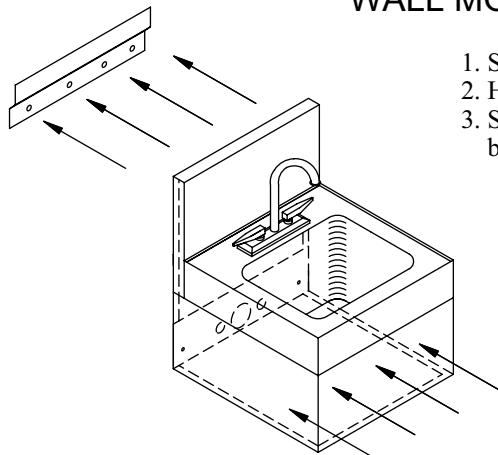

1. Secure bracket to wall.
2. Hang sink on bracket.
3. Screw sink to wall through bracket on bottom back of sink.