

Product Specifications Sheets

NEW SERIES



Model No.	Description	Depth	Length	Height	Voltage	Amps	HP/ BTUs	Power Cord	Est. Ship Weight
SC-OS35E-3	Self contained	34.5"	39"	44"	115	12.0	1/2	5-15P	463
SC-OS35E-4	Self contained	34.5"	51"	44"	115	13.1	1/2	5-20P	494
SC-OS35E-5	Self contained	34.5"	63"	44"	115	16.0	3/4	5-20P	520
SC-OS35E-6	Self contained	34.5"	75"	44"	115	16.0	3/4	5-20P	546
REMOTE									
R-OS35E-3	Remote	34.5"	39"	44"	115	0.7	3658	No	417
R-OS35E-4	Remote	34.5"	51"	44"	115	1.4	4875	No	445
R-OS35E-5	Remote	34.5"	63"	44"	115	1.4	6096	No	468
R-OS35E-6	Remote	34.5"	75"	44"	115	1.4	7316	No	492

MODEL NUMBER SUFFIX - B = Black W = White S = Stainless Steel

- Cases are designed to operate at 75 degrees Fahrenheit and 55% relative humidity
- Specification subject to change without notice



A Division of HMC Enterprises LLC • 831 East Cayuga St • Philadelphia, PA 19124 USA

(215) 464-6800 • 1-800-344-8222 • Fax (215) 969-4890 • E-Mail: sales@howardmccray.com • www.howardmccray.com

Standard Specifications and Optional Features

CONSTRUCTION

- UL Classified to ANSI/NSF 7
- Foamed in place CFC free foam
- Heavy gauge steel super structure
- Multi deck
- Endless design allows for continuous line up

INTERIOR

- White, black, or stainless steel end panels
- Removable white, black, or stainless steel floor pans
- White, black, or stainless steel perforated rear wall (for even air distribution)
- Step shelves
- Condensate pan

EXTERIOR

- White, black, or stainless steel ends and front
- White, black, or stainless steel color band
- Removeable front grill allows for cleaning and servicing
- 1" bumper
- Choice of end panels Curved or Straight plexi

FINISHES

- White, black, or stainless exterior
- White, black, or stainless steel interior
- Laminate exterior
- Custom paint exterior

ELECTRICAL REQUIREMENTS

- Cord and Plug
- 3' 115V, 5-15P,
- 4'-5'-6' 115V, 5-20P,
- See Tech page for details on voltage

REFRIGERATION

- R404A expansion valve system
- Low velocity fans located below deck area (to insure even flow of air)
- Electronic Control System with automatic air defrost to Maintain Balanced Temperatures
- New high efficiency air screen technology
- Self contained system
- Copeland hermetic unit
- Remotes available

OPTIONAL FEATURES

- LED lights at top of the unit
- Night covers
- Security cover
- Insulated divider for line ups
- Plexiglas divider for line ups
- Colored bumper
- 2 Different end panel choices
- Digital thermometer

Important Note:

All refrigerated cases are designed to operate in an environment of 75 degrees and 55% relative humidity. Product must be cooled before being displayed within the case.

DRAIN IS REQUIRED



Technical Data

		Remote or Self Contained			
Model No.		SC-OS35E-3 R-OS35E-3	SC-OS35E-4 R-OS35E-4	SC-OS35E-5 R-OS35E-5	SC-OS35E-6 R-OS35E-6
Length with (2) ends		39"	51"	63"	75"
Length without ends		36"	48"	60"	72"
Height with ends		44"	44"	44"	44"
Height without ends		43-7/8"	43-7/8"	43-7/8"	43-7/8"
Depth with ends		34-1/2"	34-1/2"	34-1/2"	34-1/2"
Depth without ends		34"	34"	34"	34"
Endless design		YES	YES	YES	YES
(Dimensions are +/- 1/4")					
Operating temperature		36°F to 40°F	36°F to 40°F	36°F to 40°F	36°F to 40°F
Refrigerant	SC	R404A	R404A	R404A	R404A
Expansion Valve	R	R404A	R404A	R404A	R404A
Compressor size HP	SC	1/2	1/2	3/4	3/4
Defrost	Air Defrost	Electronic controlled	Electronic controlled	Electronic controlled	Electronic controlled
Defrost per day	R.	1 per day	1 per day	1 per day	1 per day
BTU's at +20°F Evap. Temp.	R	3658	4875	6096	7316
Voltage	SC	115	115	115	115
Amperage	SC	12.0	13.1	16.0	16.0
Remote Voltage	R	115	115	115	115
Amperage, lights only	R	0.7	1.4	1.4	1.4
Cord and plug	SC	5-15P	5-20P	5-20P	5-20P
	R	NO	NO	NO	NO
Exterior color		W, B, S	W, B, S	W, B, S	W, B, S
Interior color		W, B, S	W, B, S	W, B, S	W, B, S
Shelves		Step shelf	Step shelf	Step shelf	Step shelf
Shipping Info					
Height		54"	54"	54"	54"
Depth		44"	44"	44"	44"
Length		61"	61"	87"	87"
Gross weight SC/R		463/417	494/445	520/468	546/492
Cubic feet		75	75	75	75

(ALL WHITE OR ALL BLACK, NO EXTRA CHARGE—IF COLORS ARE MIXED AN ADDITIONAL CHARGE WILL APPLY)

Prefix

SC = Self Contained
R = Remote

Suffix

B = Black
W = White
S = Stainless Steel
LED = LED lighting

- Cases are designed to operate at 75 degrees Fahrenheit and 55% relative humidity
- Cases are equipped with drains; check your local building codes for connection requirements.
- Specification subject to change without notice
- Remotes supplied with R404A-Expansion Valve* (does not include solenoid valves)
- All refrigerant and expansion values are subject to change per SNAP (EPA) regulations.



Technical Data • Side View • Plan View

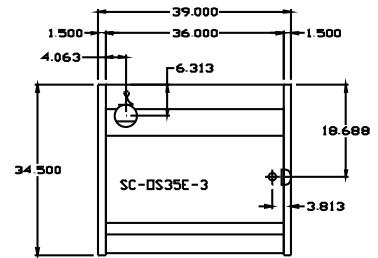
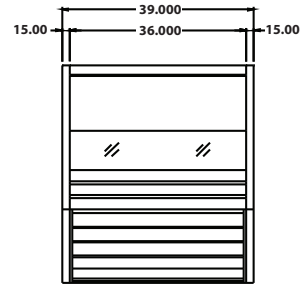
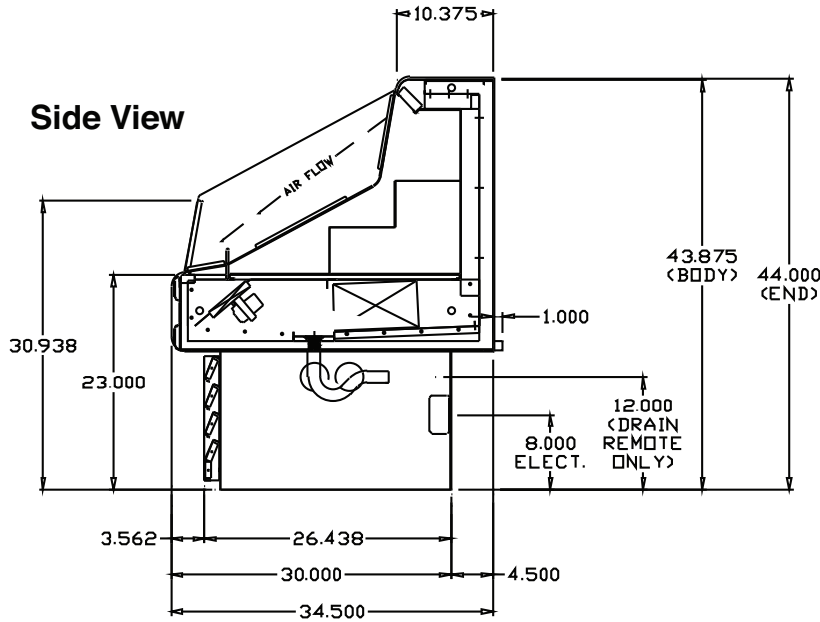

3' Plan View

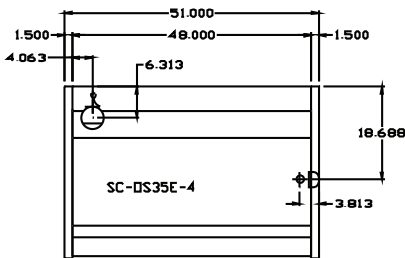
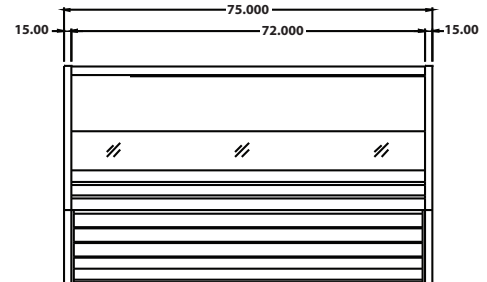
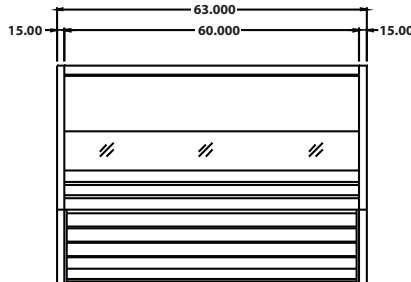
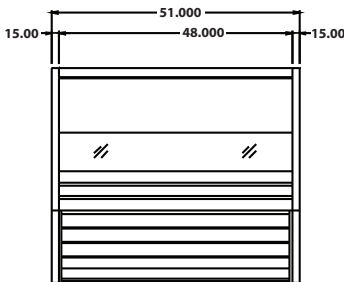

4' Plan View

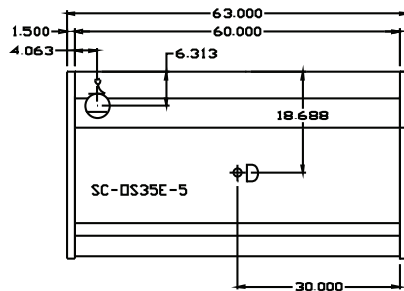

5' Plan View

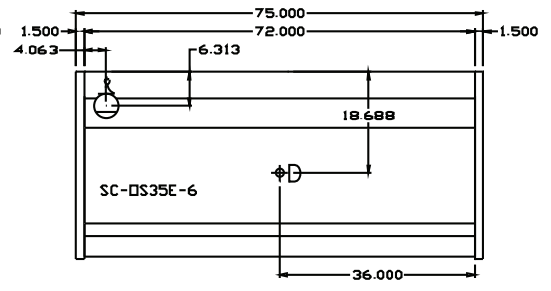

6' Plan View

