



SERVING THE FOOD INDUSTRY SINCE 1951

74-INCH BLADE TABLETOP BAND SAW

Item: 10274 Model: BS-BR-1880



**CUT SLABS OF MEAT QUICKLY,
EASILY, AND PRECISELY**

Boasting a razor sharp 74" blade and a powerful 1/2 HP motor, Omcan's tabletop band saw is perfect for supermarket and butcher shops. It features a sliding stainless steel table, a cut regulator, and a pushing lever. Easy to operate.



LIMITED WARRANTY
PARTS AND LABOR

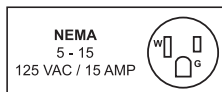

Authorized Dealer

FOOD EQUIPMENT

74-INCH BLADE TABLETOP BAND SAW | BS-BR-1880 10274



Features

- Sliding stainless steel table, cut regulator, and a pushing lever
- 4-teeth per inch stainless steel blades
- Guide plate and pushing lever for easy cutting



Pushing Lever + Gate



Blade Tension Regulator

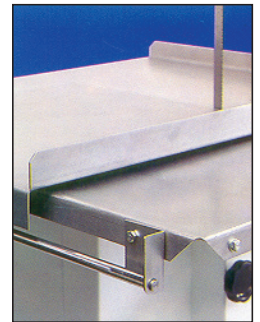

Sliding Table

TECHNICAL SPECIFICATION

ITEM NUMBER	10274
MODEL	BS-BR-1880
BLADE LENGTH	74" / 1880 mm
CUTTING CAPACITY (H*W)	10" x 8.5" / 254 x 216 mm
POWER	0.5 HP / 0.37 kW
ELECTRICAL	110 V / 60 Hz / 1 Ph
WEIGHT	77 lbs. / 35 kg.
PACKAGING WEIGHT	131 lbs. / 59 kg.
DIMENSIONS (DWH)	19.7" x 25.2" x 38.6" 500 x 640 x 980 mm
PACKAGING DIMENSIONS	32" x 27" x 42" 813 x 686 x 1067 mm

TECHNICAL DRAWING AND DIMENSIONS

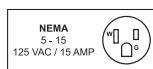
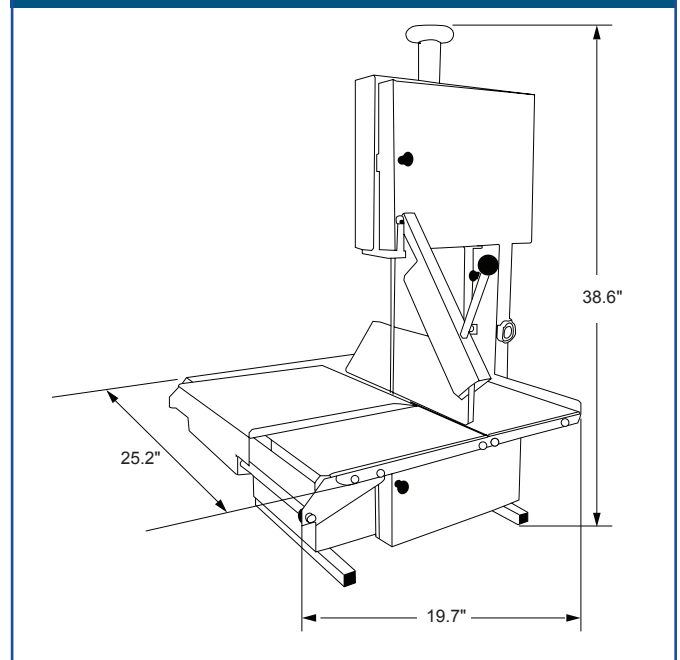

OMCAN INC.

Telephone: 1-800-465-0234
Fax: (905) 607-0234
Email: sales@omcan.com
Website: www.omcan.com



Follow us to keep up to date with the latest news and offers



2015.E.O.E