



SERVING THE FOOD INDUSTRY SINCE 1951

MATURMEAT® MATURATION CABINET

Model: MATC060TF
Model: MATC200TF

Model: MATC100TF
Model: MATCTWTF

Model: MATC150TF
Model: MATC400TF



Maturmeat®

Maturmeat® contributes to environmental protection!

Only solar energy has been used for its construction
Saving 213.6 Kg of Co2 for every Maturmeat™
produced equaling 74.760 Kg every year.

Every Maturmeat® SAVES 213.6 Kg of CO₂ from our environment

AGE MEAT AS LITTLE AS **11 DAYS!**



60kg Capacity
Model MATC060TF



150kg Capacity
Model MATC150TF



WARRANTY
PARTS AND LABOR



PRODUCED USING
100%
Solar Energy



Authorized Dealer

Maturmeat®

Produce your own prime quality meats!

Maturmeat® is the only maturation cabinet guaranteed, patented and manufactured 100% in Italy that reproduces a series of microclimates ideal for the traditional maturation of meat (dry aged). In as little as eleven days our system allows you to transform your meat into tender, juicy steaks, safely. Maturmeat® is equipped with an industrial refrigeration system (not monoblock). Thanks to the patented Fumotic® system, it ensures the production and management of humidity used to reduce the weight loss of the meat. In addition, since the user can smoke/avor the product at low temperatures, without any combustion, it safely keeps the organoleptic properties of the meat unchanged. Maturmeat®, unlike wet aging, where the meat from its vacuum-sealed bag must be consumed immediate after opening, allows you to hang, store and consume meat in a longer period of time without similar risks. The unit is equipped with an advanced touch screen controller, that automatically manages the temperature, humidity, air speed, pH monitoring, smoke/avoring for the duration of the recipe. The Climatouch® controller, built into Maturmeat®, allows you to quickly start your next recipe, monitor recipe values, create and save new recipes, calibrate the optional pH probe and review HACCP data. These features and more make Maturmeat® one of a kind.

Fumotic® **ClimaTouch®**



60kg Capacity
Model MATC060TF



100kg Capacity
Model MATC100TF



150kg Capacity
Model MATC150TF



200kg Capacity
Model MATC200TF



100 + 100kg Capacity
Model MATCTWTF



400kg Capacity
Model MATC400TF

OMCAN INC.

Telephone: 1-800-465-0234
Fax: (905) 607-0234
Email: sales@omcan.com
Website: www.omcan.com



Follow us to keep up to date with the latest news and offers



FOOD EQUIPMENT

MATURMEAT® MATURATION CABINET

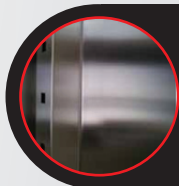

Made in Stainless Steel AISI 304

The most important advantage of using stainless steel AISI 304 is the fact that it is non-porous and easier to clean



Energy Efficient

The AISI 304 Stainless Steel body and doors are fully injected with CFC free polyurethane foam creating a unibody frame and higher R-value

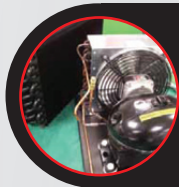

Professional grade Non Monoblock system

Our non monoblock system is comprised of various components specially designed with the capability to be used for seasoning and dry aging, and can function in an ambient temperature range for up to +32°C (89.6°F)

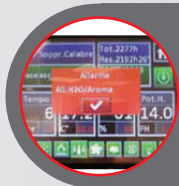

Alarms

There are a number of alarms built into the system to protect the Maturmeat®

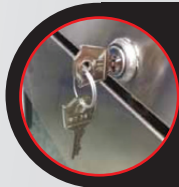

Lock and Key

Equipped with a lock and key system for additional safety



Probes

There are 4 standard probes included in all Maturmeat® units.

- Humidity probe which monitors the ambient humidity inside the entire chamber
- Ambient probe to monitor the temperature inside the entire chamber
- Evaporator/defrost probe to visualize the temperature of evaporation and controls the temperature of defrosting in order to conserve energy
- Condenser probe to visualize the temperature of the condenser

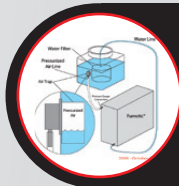
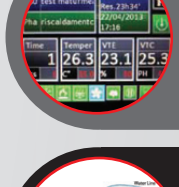

Tank

The tank system is designed to work with the Fumotic® to provide humidity when needed and aroma flavor as desired by the user.

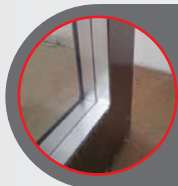

Doors

The doors are designed and built in AISI 304 stainless steel, dual insulated glass panels with UV protection of 59%, pressure valve for high altitudes, resistance lines to minimize condensation and soften door seals at lower temperatures.

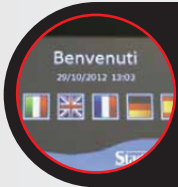

Climatouch®

A revolutionary automatic control system with a 6-inch touch screen display that automatically manages all sequential processing stages, calculating pH levels during the fermentation process guaranteeing a quality product. It includes preset recipes and allows the user to have access to the system which controls the functionality of the unit.



Pre-Calibrated pH Probe (Optional Item 41263)

Our pH probe is designed to connect to a PLC and communicate data from the product to the Display, record and store it for later use.



Fumotic®

This is a dual purpose system for regulating humidity and flavoring

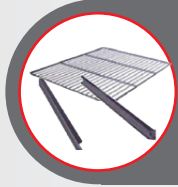

Guide Sets, Hanging Rods, Grills/Racks

(Not applied to MATC400TF)

Standard guide sets and rods are made from AISI 304 and are suited to distribute the weight of the maximum amount of product designed for that unit.



Adjustable Legs

All units are equipped with AISI 304 stainless steel adjustable legs for uneven floors. There is an optional 13cm (5.2") wheel kit available for those who need increased mobility.

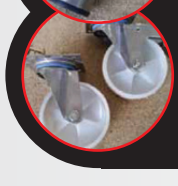

Produce your own prime quality meats all year round

OMCAN INC.

Telephone: 1-800-465-0234

Fax: (905) 607-0234

Email: sales@omcan.com

Website: www.omcan.com



Follow us to keep up to date with the latest news and offers



FOOD EQUIPMENT

60Kg/100Kg/150 Kg MATUREMEAT® MATURATION CABINETS



60kg Capacity Model MATC060TF

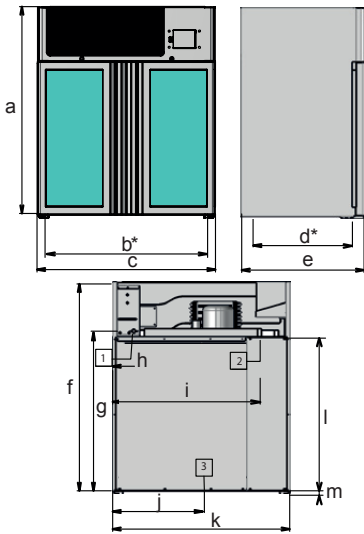

Dimensions:

- a. 1430 mm
- b. 950 mm*
- c. 1100 mm
- d. 653 mm*
- e. 780 mm
- f. 1340 mm
- g. 1040 mm
- h. 145 mm
- i. 900 mm
- j. 860 mm
- k. 1100 mm
- l. 1030 mm
- m. 45 mm

100kg Capacity Model MATC100TF

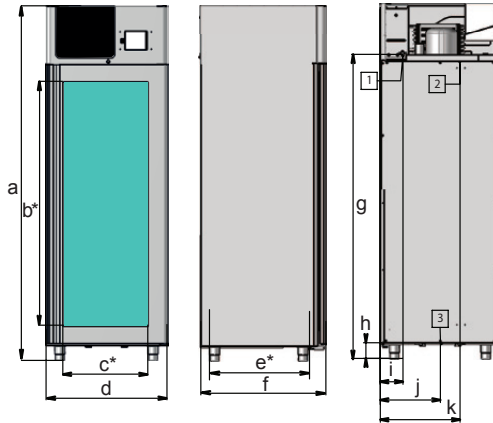

Dimensions:

- a. 2110 mm
- b. 1360 mm*
- c. 530 mm*
- d. 730 mm
- e. 650 mm
- f. 780 mm
- g. 1790 mm
- h. 140 mm
- i. 135 mm
- j. 420 mm
- k. 600 mm

150kg Capacity Model MATC150TF

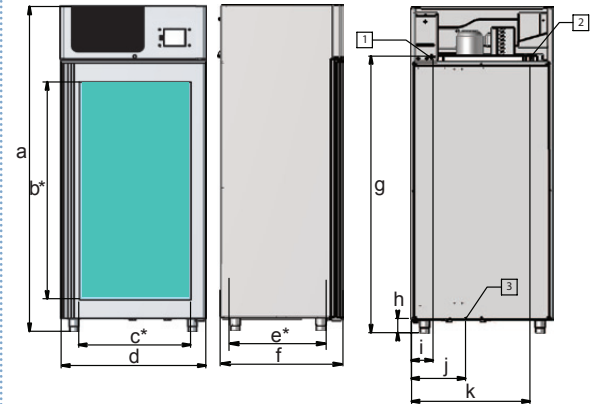

Dimensions:

- a. 2110 mm
- b. 1360 mm*
- c. 710 mm*
- d. 900 mm
- e. 650 mm*
- f. 780 mm
- g. 1790 mm
- h. 140 mm
- i. 135 mm
- j. 310 mm
- k. 780 mm

1. Water inlet 3/4" Dia.

2. Electrical connection 220v

3. Water outlet 1/2" Dia.

*Internal dimensions



TECHNICAL SPECIFICATIONS

ITEM NUMBER	45143	40345	40299
MODEL	MATC060TF	MATC100TF	MATC150TF
DESCRIPTION	Maturmeat® 60kg wall cabinet with ClimaTouch® and Fumotic®	Maturmeat® 100kg cabinet with ClimaTouch® and Fumotic®	Maturmeat® 150kg cabinet with ClimaTouch® and Fumotic®. Dual internal fans & air exchange kit included
INTERIOR	2+2 Guide sets/ 2+2 stainless steel shelves	5 Guide sets/ 5 stainless steel shelves	5 Guide sets/ 5 stainless steel shelves
WORKING TEMPERATURE	- 5 - 50°C / 23 - 122°F	- 5 - 50°C / 23 - 122°F	- 5 - 50°C / 23 - 122°F
STORAGE TEMPERATURE	-10 - 70°C / 14 - 158°F	-10 - 70°C / 14 - 158°F	-10 - 70°C / 14 - 158°F
AMBIENT RELATIVE HUMIDITY	Less than 90% RH	Less than 90% RH	Less than 90% RH
ELECTRICAL	220V/2.376kW/10.8A	220V/2.376kW/10.8A	220V/3.5kW/13A
INTERNAL MEMORY	352 Kb Ram (approx. 100 recipes)	352 Kb Ram (approx. 100 recipes)	352 Kb Ram (approx. 100 recipes)
NET WEIGHT	150 kg (330 lbs)	140 kg (308 lbs)	200 kg (440 lbs)
GROSS WEIGHT	225 kg (495 lbs)	215 kg (473 lbs)	305 kg (671 lbs)
DIMENSIONS(DWH)	30.7" x 43.3" x 52.75"/ 780 x 1100 x 1340 mm	30.7" x 28.74" x 83"/ 780 x 730 x 2110 mm	30.7" x 35.43" x 83"/ 780 x 900 x 2110 mm
OPTIONAL ITEM	Item 41263 (PH probe)		

OMCAN INC.

Telephone: 1-800-465-0234
 Fax: (905) 607-0234
 Email: sales@omcan.com
 Website: www.omcan.com



Follow us to keep up to date with the latest news and offers



FOOD EQUIPMENT

200Kg & 100 + 100Kg MATUREMEAT® MATURATION CABINETS



200kg Capacity Model MATC200TF

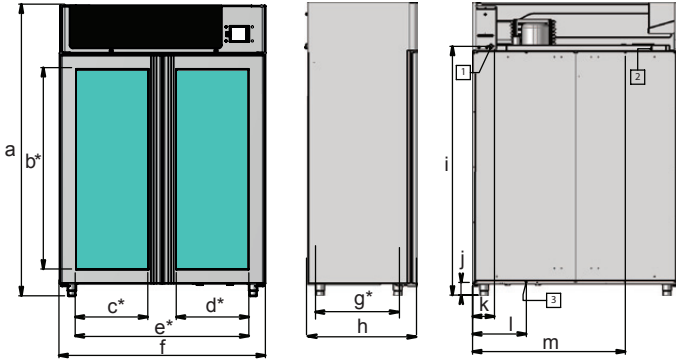

Dimensions:

- a. 2115 mm
- b. 1360 mm*
- c. 570 mm*
- d. 570 mm*
- e. 1280 mm*
- f. 1465 mm
- g. 650 mm*
- h. 785 mm
- i. 1790 mm
- j. 140 mm
- k. 135 mm
- l. 310 mm
- m. 1340 mm

100 + 100kg Capacity Model MATCTWTF

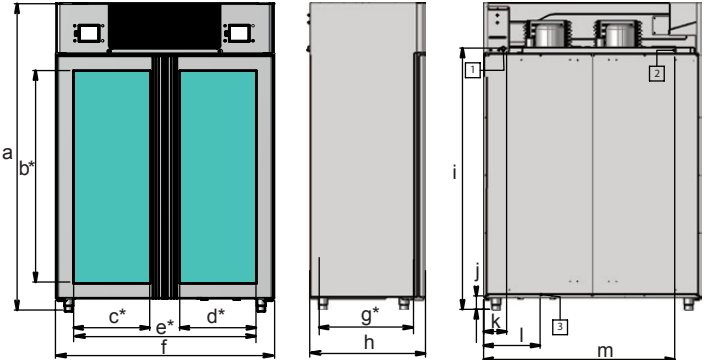

Dimensions:

- a. 2115 mm
- b. 1360 mm*
- c. 570 mm*
- d. 570 mm*
- e. 1280 mm*
- f. 1465 mm
- g. 650 mm*
- h. 785 mm
- i. 1790 mm
- j. 140 mm
- k. 135 mm
- l. 310 mm
- m. 1340 mm

1. Water inlet 3/4" Dia.

2. Electrical connection 220v

3. Water outlet 1/2" Dia.

*Internal dimensions



TECHNICAL SPECIFICATIONS

ITEM NUMBER	41187	45176
MODEL	MATC200TF	MATCTWTF
DESCRIPTION	Maturmeat® 200kg cabinet with ClimaTouch® and Fumotic®	Maturmeat® 100 + 100kg cabinet with ClimaTouch® and Fumotic®
INTERIOR	10 Guide sets/ 10 stainless steel shelves	5+5 Guide sets/ 5+5 stainless steel shelves
WORKING TEMPERATURE	- 5 - 50°C / 23 - 122°F	- 5 - 50°C / 23 - 122°F
STORAGE TEMPERATURE	-10 - 70°C / 14 - 158°F	-10 - 70°C / 14 - 158°F
AMBIENT RELATIVE HUMIDITY	Less than 90% RH	Less than 90% RH
ELECTRICAL	220V/4.14kW/18A	220V/3.7kW/17A
INTERNAL MEMORY	352 Kb Ram (approx.100 recipes)	352 Kb Ram (approx.100 recipes)
NET WEIGHT	250 kg (551.2 lbs)	250 kg (551.2 lbs)
GROSS WEIGHT	376 kg (829 lbs)	376 kg (829 lbs)
DIMENSIONS(DWH)	31" x 58" x 83" / 785 x 1465 x 2115 mm	31" x 58" x 83" / 785 x 1465 x 2115 mm
OPTIONAL ITEM	Item 41263 (PH probe)	

OMCAN INC.

Telephone: 1-800-465-0234

Fax: (905) 607-0234

Email: sales@omcan.com

Website: www.omcan.com



Follow us to keep up to date with the latest news and offers



FOOD EQUIPMENT

400Kg MATUREMEAT® MATURATION CABINET



400kg Capacity Model MATC400TF

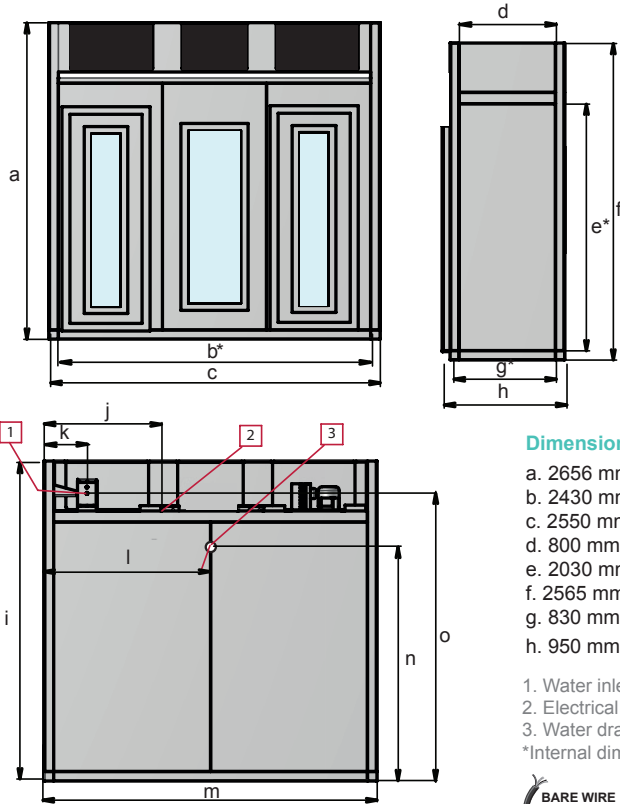

Dimensions:

- | | |
|-------------|------------|
| a. 2656 mm | i. 2656 mm |
| b. 2430 mm* | j. 900 mm |
| c. 2550 mm | k. 410 mm |
| d. 800 mm* | l. 1275 mm |
| e. 2030 mm* | m. 2550 mm |
| f. 2565 mm | n. 1945 mm |
| g. 830 mm* | o. 2170 mm |
| h. 950 mm | |

1. Water inlet 3/4" Dia.
 2. Electrical connection 380v
 3. Water drain 20mm Dia.
- *Internal dimensions



TECHNICAL SPECIFICATIONS

ITEM NUMBER	45344
MODEL	MATC400TF
DESCRIPTION	Maturmeat® 400kg cabinet with ClimaTouch® and Fumotic®. Air exchange kit included
INTERIOR	Automatic internal lighting, dehumidifier, air exchange, heated frame, hot gas defrost, and industrial refrigeration unit.
WORKING TEMPERATURE	- 5 - 50°C / 23 - 122°F
STORAGE TEMPERATURE	-10 - 70°C / 14 - 158°F
AMBIENT RELATIVE HUMIDITY	Less than 90% RH
ELECTRICAL	380V/5.15kW/23A
INTERNAL MEMORY	352 Kb Ram (approx.100 recipes)
NET WEIGHT	-
GROSS WEIGHT	-
DIMENSIONS (DWH)	37" x 100" x 104.6" / 950 x 2550 x 2656 mm
OPTIONAL ITEM	Item 41263 (PH probe)

OMCAN INC.

Telephone: 1-800-465-0234
 Fax: (905) 607-0234
 Email: sales@omcan.com
 Website: www.omcan.com



Follow us to keep up to date with the latest news and offers

