

Camshelving®

PREMIUM
series



ELEMENTS
series



BASICS
series



CAMBRO
TRUSTED FOR GENERATIONS™

www.cambro.com

Shelving for Life

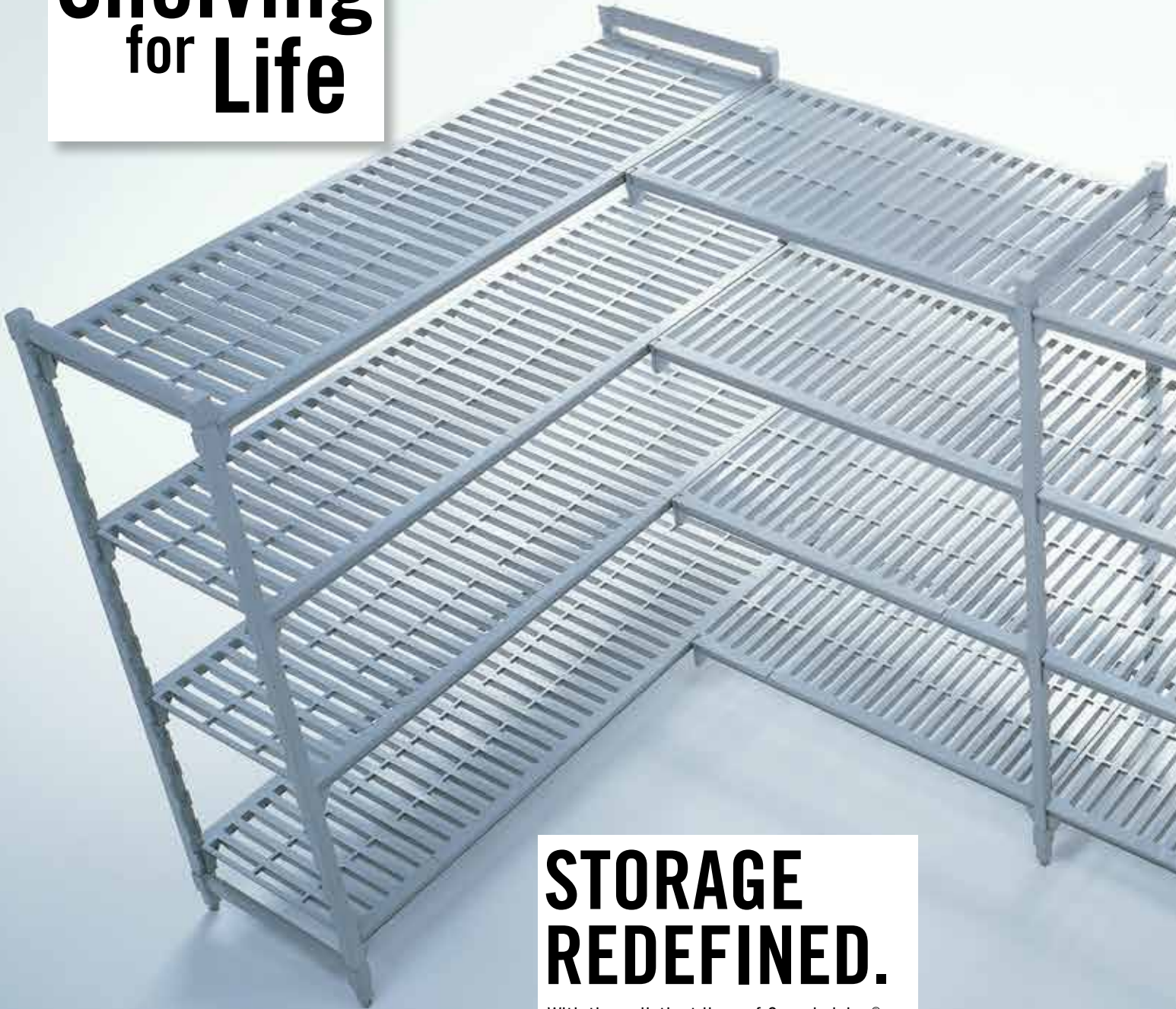

STORAGE REDEFINED.

With three distinct lines of Camshelving®, all kitchens are created equal!

Every foodservice operation deserves to be set up for maximized cost savings, space efficiency, sanitation, food safety and functionality no matter what the size or budget.

Camshelving storage systems make it all possible, helping foodservice operators optimize organization, support food safety, improve labor savings, simplify inventory management, reduce food waste, and eliminate replacement costs.



04 **CAMSHELVING®**
key features

06 **COMPARISON**
quick reference guide

08 **PRODUCT CODE**
reference guide

10 **OVERALL LENGTH**
quick reference guide

12 **PREMIUM**
series

26 **ELEMENTS**
series

36 **BASICS**
series

Camshelving® is covered under the following US Patents:

D498,664 S, D508,646 S, D512,867 S, D623,929 S, D624,764 S, D648,582 S, D630,935 S, D648,159 S, D651,433 S, D648,160 S, D697,391 S, D727,715 S, D728,347 S, D728,348 S, D707,994 S, D739,989 S, D663,912 S, D736,488 S, D739,989 S, US 6,981,454B2



Cambo storage and transportation products that help ensure food safety handling.



COMPONENT

Products that meet the NSF International criteria for sanitation and cleanability.



Certifies products approved by Technischer Überwachungs-Verein. (Technical Inspection Association)



Products that help meet HACCP guidelines.



Fit for food products



Dishwasher Safe



Cadmium-free products



Recyclable polypropylene

camguard
ANTIMICROBIAL SHELF PLATES

Antimicrobial protection permanently molded into shelf plates to inhibit the growth of mold, fungus and bacteria.

CAMSHELVING®

THE COMMON AND KEY FEATURES OF ALL CAMSHELVING SERIES

Rust and Corrosion Free

Backed by a lifetime warranty against rust and corrosion, Camshelving storage systems eliminate the inconvenience and costs associated with restoring or replacing degraded shelving. Only Cambro offers Shelving for Life.



Multi Environment Use

Camshelving storage systems are designed to withstand all extreme storage applications and temperatures — impervious to moisture, chemicals, salt, food acids, and humidity. Camshelving systems can be installed anywhere and will never rust.

-36°F TO 190°F



Maximized Space Utilization

Components have been thoughtfully designed to maximize storage space, even in space-restricted areas.

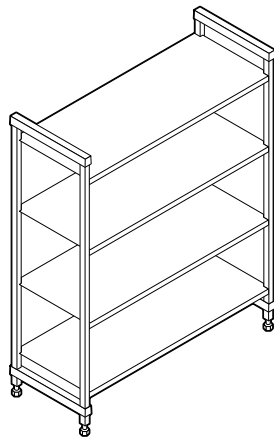

Starter Unit

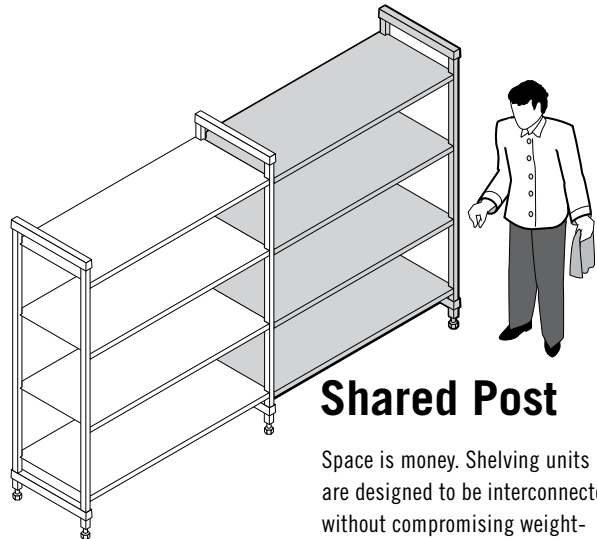

Starter + Add-On Unit

Shared Post

Space is money. Shelving units are designed to be interconnected, without compromising weight-bearing capacity all while maximizing usable storage space.

PREMIUM series

ELEMENTS series

BASICS series

Easy to Clean

Cleaning shelving shouldn't be a major production. Whether daily or scheduled, cleaning can be done quickly and easily without interrupting storage space or normal, day-to-day operations.



Easy to Adjust

Each shelf can be easily and independently adjusted to accommodate a variety of storage products and packages as product and storage needs change.

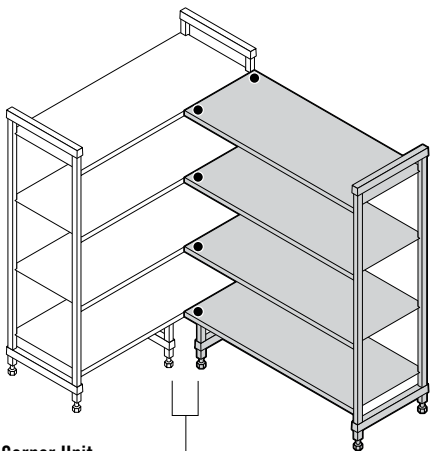

Corner Unit
Starter + Add-On Unit
using 1 set of Corner
Connectors per shelf
and 2 Dunnage Stands.

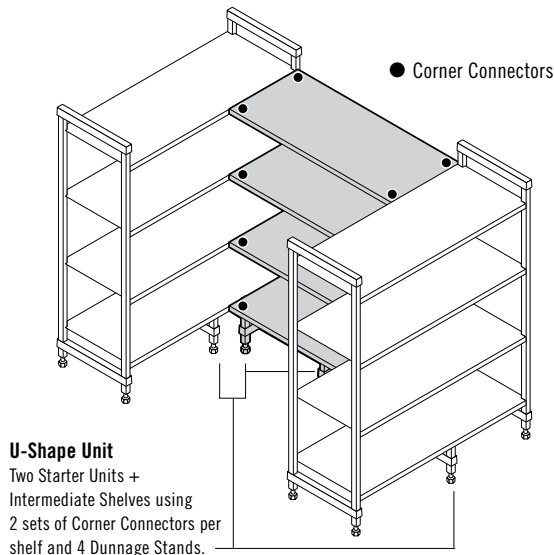

U-Shape Unit
Two Starter Units +
Intermediate Shelves using
2 sets of Corner Connectors per
shelf and 4 Dunnage Stands.

Corner Shelf Space

Convert unusable space into continuous, easy-access storage areas using corner connectors.

Camshelving® Series Quick Reference Guide

Cambro offers three rust-free, non-corrosive, hygienic shelving systems that will hold up to the tough demands of commercial foodservice operations. This guide will help you choose the ideal Camshelving system for each storage area in your operation. Only Cambro offers Shelving for Life.



camguard
ANTIMICROBIAL SHELF PLATES

PREMIUM series

Storage Areas	High-volume foodservice operations with constant loading and off-loading of heavy products. Frequent and/or multiple daily deliveries. Wet Storage - Walk-in Freezers, Coolers, Warewashing Areas Dry Storage - Bulk Foods, Catering Equipment, China/Dishware, Linen, Merchandising.
Recommended Market Segments	Hotels and Casinos, Restaurants, Quick-Serve Restaurants, Schools, Colleges and Universities, Healthcare, Military, Convention Centers/Stadiums, Cruise Ships, Caterers and Banquet Centers, Corporate Dining, Convenience and Grocery Stores.
Product Material	Posts and traverses are made from a steel core with smooth polypropylene exterior. Superior strength and durable enough to withstand the heaviest loading demands.
Assembly	Molded in dovetails means fewer parts, making it the easiest to assemble.
Weight-Bearing Capacity (based on 24" - 48" length)	Stationary Unit: 800 lbs. per shelf, 3200 lbs. per unit. Mobile Unit: 750 lbs. per unit. Corner and U-Shape Unit: 400 lbs. per shelf, 1600 lbs. per unit.
Lifetime Warranty Against Rust & Corrosion	Shelf Plates, Stationary Posts and Traverses
Shelf Lengths	24", 30", 36", 42", 48", 54", 60", 72"
Shelf Depths	14", 18", 21", 24"
Post Heights	Stationary: 32", 56", 64", 72", 84" Mobile: 35", 59", 67", 75" (includes casters)
Mobile Units	YES
High Density Storage Floor Track System	YES
Bottom Shelf Dunnage Stand	YES
Shelf Rails	YES
Vertical Drying and Storage Cradle (Trays / Cutting Boards / Lids)	YES
Dome Drying and Storage Cradle	YES
Angled Drying and Storage Cradle	YES
Shelf Divider (Narrow Item Storage)	YES
Shelf Divider Bar (for Food Pans or Food Boxes)	YES
Tray Sliding Rack	YES
Single Shelf Security Cage	YES
Full Wrap Security Cage	YES

ACCESSORIES



ELEMENTS series

BASICS series

High-volume foodservice operations with constant loading and off-loading of medium to heavy products. 5-7 deliveries per week.

Wet Storage - Walk-in Freezers, Coolers, Warewashing Areas

Dry Storage - Bulk Foods, Catering Equipment, China/Dishware, Linen, Merchandising.

Medium-volume foodservice operations with constant loading and off-loading of light to medium products. 2-5 deliveries per week.

Wet Storage - Walk-in Freezers, Coolers, Warewashing Areas

Dry Storage - Bulk Foods, Catering Equipment, China/Dishware, Linen, Merchandising, Disposables.

Hotels and Casinos, Restaurants, Quick-Serve Restaurants, Schools, Colleges and Universities, Healthcare, Military, Convention Centers/Stadiums, Cruise Ships, Caterers and Banquet Centers, Corporate Dining, Convenience and Grocery Stores.

Hotels and Casinos, Restaurants, Quick-Serve Restaurants, Schools, Colleges and Universities, Healthcare, Convention Centers/Stadiums, Caterers and Banquet Centers, Corporate Dining, Convenience Stores, Yogurt Shops and Cafés.

Posts and traverses are made from a revolutionary composite material that is light in weight yet strong enough to withstand rigorous loading conditions.

Posts and traverses are made from the same revolutionary composite material as Elements Series. Slim design is lighter in weight, yet durable and strong enough to withstand a wide variety of storage conditions.

Easy to assemble.

Easy to assemble.

Stationary Unit: 800 lbs. per shelf, 3200 lbs. per unit.
Mobile Unit: 750 lbs. per unit.
Corner and U-Shape Unit: 400 lbs. per shelf, 1600 lbs. per unit.

Stationary Unit: 600 lbs. per shelf, 2200 lbs. per unit.
Corner and U-Shape Unit: 300 lbs. per shelf, 1200 lbs. per unit.

Shelf Plates, Posts and Traverses

Shelf Plates, Posts and Traverses

24", 30", 36", 42", 48", 54", 60", 72"

30", 36", 42", 48", 54", 60"

14", 18", 21", 24"

18", 21", 24"

Stationary: 64", 72", 84"
Mobile: 70", 78" (includes casters)

Stationary: 64", 72", 84"

YES

NO

NO

NO

YES

YES

NO

NO

YES

NO

YES

NO

YES

NO

YES

NO

YES

NO

YES

NO

YES

NO

NO

NO

Product Code Reference Guide

Cambro's new product codes have been simplified making it easier to identify the type of unit or accessory required. Code numbers are composed of 3 parts.

1. **Prefix** – Defines the shelving brand and type of unit being selected.
2. **Dimensions** – Identifies the depth, length and height.
3. **Suffix** – Type and quantity of shelves.

Complete Units

CP Camshelving® Premium Series

- CPU Stationary Starter Unit
- CPA Stationary Add-On Unit
- CPMU Mobile Unit
- CPHU High Density Mobile Unit

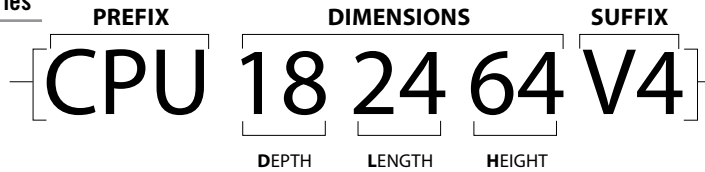

E Camshelving Elements Series

- ESU Stationary Starter Unit
- EA Stationary Add-On Unit
- EMU Mobile Unit

CB Camshelving Basics Series

- CBU Stationary Starter Unit
- CBA Stationary Add-On Unit

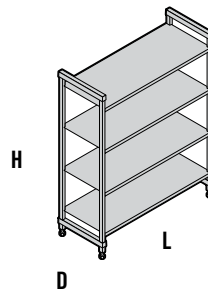

V4 4 Vented Shelves

V5 5 Vented Shelves

S4 4 Solid Shelves

S5 5 Solid Shelves

VS4 3 Vented Shelves + 1 Solid Shelf

VS5 4 Vented Shelves + 1 Solid Shelf

V4PKG* 4 Vented Shelves

V5PKG* 5 Vented Shelves

S4PKG* 4 Solid Shelves

S5PKG* 5 Solid Shelves

VS4PKG* 3 Vented Shelves + 1 Solid Shelf

VS5PKG* 4 Vented Shelves + 1 Solid Shelf

* Premium Series only - 84" high units and 72" long units, all heights.

Post Kits and Shelf Kits

CP Camshelving® Premium Series

- CPSK Stationary Shelf Kit
- CPPK Stationary Post Kit
- CPMPK Mobile Post Kit

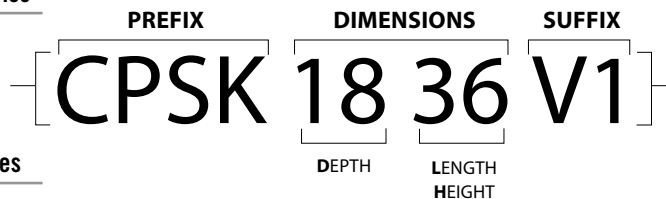

E Camshelving Elements Series

- ESK Stationary Shelf Kit
- EPK Stationary Post Kit
- EMSK Mobile Shelf Kit
- EMPK Mobile Post Kit

CB Camshelving Basics Series

- CBSK Stationary Shelf Kit
- CBPK Stationary Post Kit

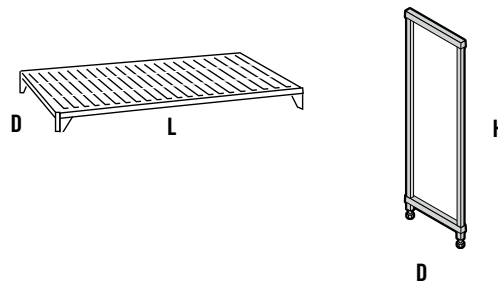

V1 1 Vented Shelf

S1 1 Solid Shelf

V4 4 Vented Shelves

V5 5 Vented Shelves

S4 4 Solid Shelves

S5 5 Solid Shelves

VS4 3 Vented Shelves + 1 Solid Shelf

VS5 4 Vented Shelves + 1 Solid Shelf

Accessories

If an accessory is used by more than 1 line of shelving, the code will start with CS.

If an accessory is only used in one line of shelving, the code will start by the prefix letters of the line.

Example: Corner Connectors:

- a. **CPCC1** = Camshelving Premium Corner Connector Set
- b. **ECC1** = Camshelving Elements Corner Connector Set
- c. **CBCC1** = Camshelving Basics Corner Connector Set

FREE Camshelving® Design Service

In order to select the most suitable and cost effective storage system, Cambro offers customized shelving illustrations using our proprietary shelving design program. Space allocation, operational flow and organizational challenges are quickly addressed when selecting the right product for the storage application. Usable storage space is maximized using the least number of units to help operators manage equipment costs. Once all required information is received, our expert shelving consultants prepare a 2D and 3D recommended floor plan along with an itemized product list by room/area. Proposals are completed and emailed within 24-48 business day hours, depending on number of rooms and complexity. We look forward to designing the perfect storage solution for you. Call or email today to connect with one of our Camshelving consultants.

Email shelving@cambro.com or call **TOLL FREE (877) 737-0663**.

It's Simple! To Get Started, Please Provide:

- Project Name
- Storage Room Type (freezer / cooler)
- Room(s) Dimensions (L x W x H)
- Doorway / Entryway Location & Dimension
- Obstructions (condenser / pipes)
- Additional Preferences / Requirements

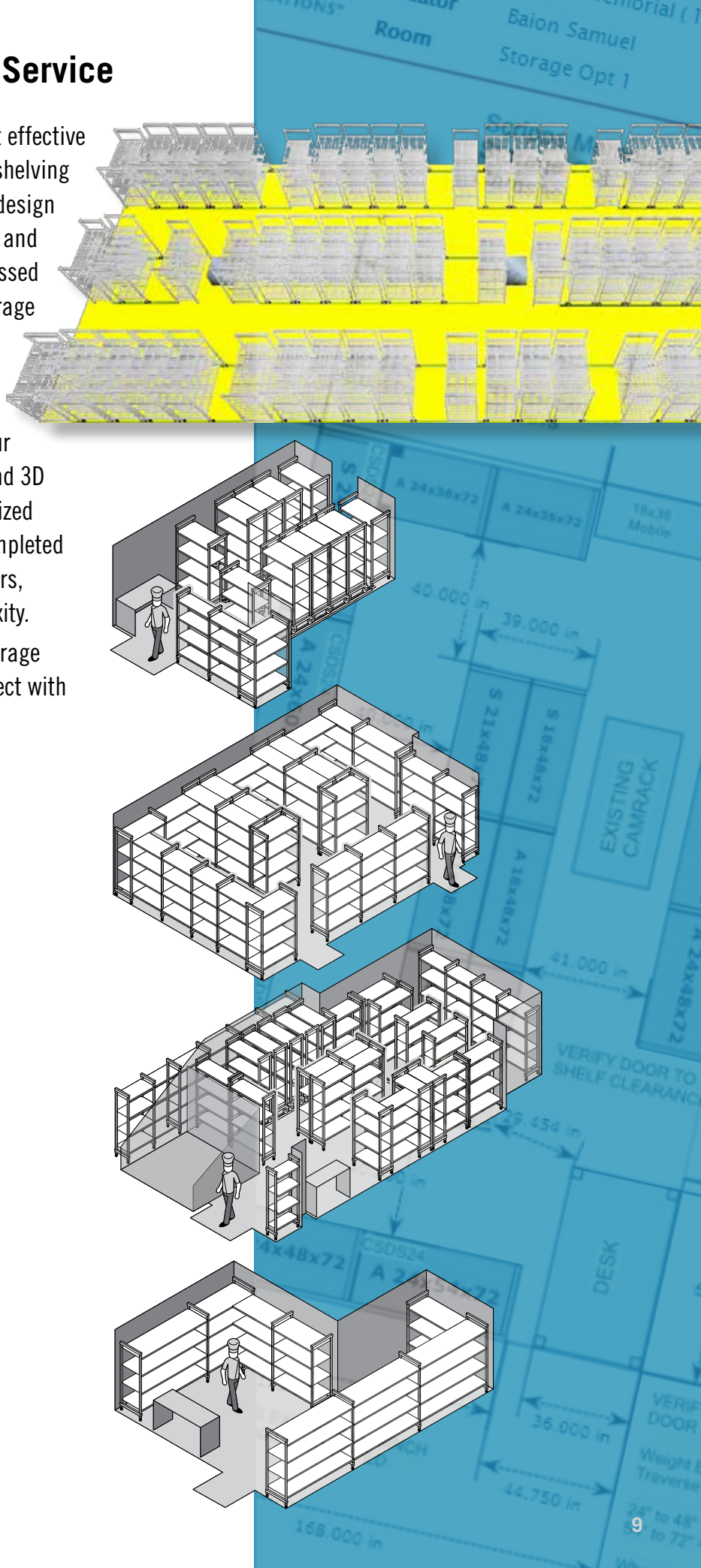

Camshelving® Series Overall Length - Quick Reference Guide

Straight Unit: Starter Unit + Add-On Unit with Shared Posts

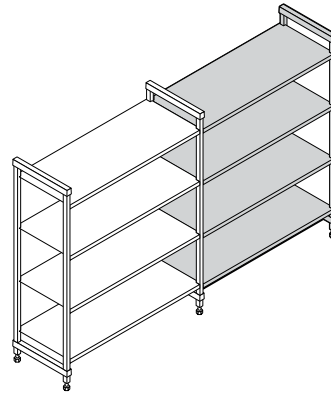
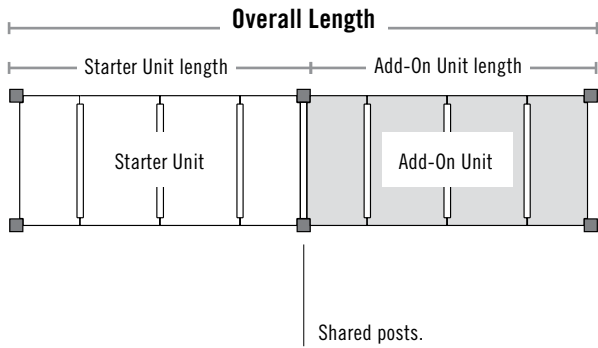

Shared posts.

Corner Unit: Starter Unit + Add-On Unit with Corner Connectors

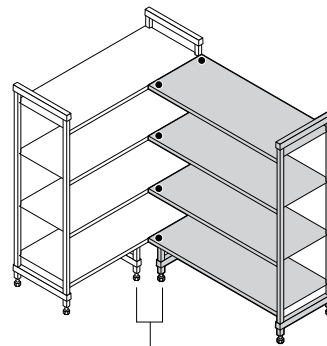
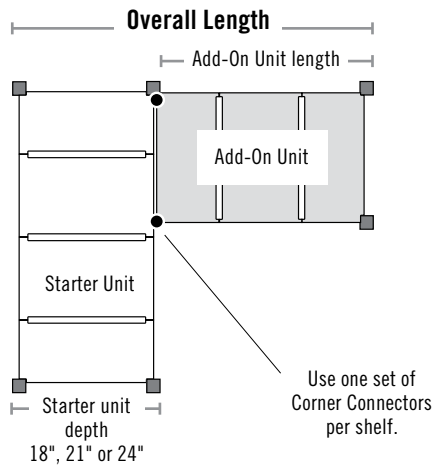

Use One Dunnage Stand under each Starter and Add-On Unit.

U-Shape Unit: Two Starter Units + Intermediate Shelves with Corner Connectors

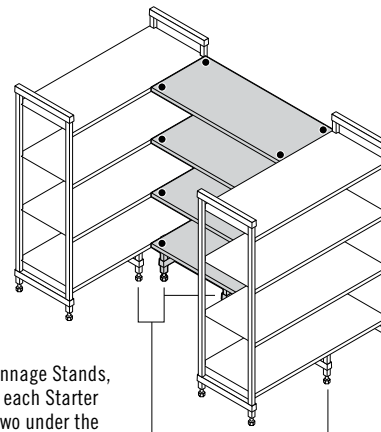
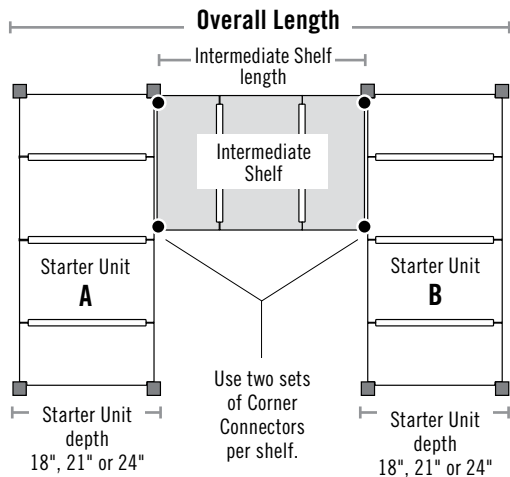

Use four Dunnage Stands, one under each Starter Unit and two under the bottom Intermediate Shelf.

Straight Unit: Starter Unit + Add-On Unit with Shared Posts

PREMIUM / BASICS SERIES					ELEMENTS SERIES					
STARTER & ADD-ON UNIT	STARTER UNIT ACTUAL LENGTH		ADD-ON UNIT ACTUAL LENGTH	=	OVERALL LENGTH	STARTER UNIT ACTUAL LENGTH		ADD-ON UNIT ACTUAL LENGTH	=	OVERALL LENGTH
24"	24"	+	22 $\frac{1}{4}$ "	=	46$\frac{1}{4}$"	24"	+	22"	=	46"
30"	30"	+	28 $\frac{1}{4}$ "	=	58$\frac{1}{4}$"	30"	+	28"	=	58"
36"	36"	+	34 $\frac{1}{4}$ "	=	70$\frac{1}{4}$"	36"	+	34"	=	70"
42"	42"	+	40 $\frac{1}{4}$ "	=	82$\frac{1}{4}$"	42"	+	40"	=	82"
48"	48"	+	46 $\frac{1}{4}$ "	=	94$\frac{1}{4}$"	48"	+	46"	=	94"
54"	54"	+	52 $\frac{1}{4}$ "	=	106$\frac{1}{4}$"	54"	+	52"	=	106"
60"	60"	+	58 $\frac{1}{4}$ "	=	118$\frac{1}{4}$"	60"	+	58"	=	118"
72"	72"	+	70 $\frac{1}{4}$ "	=	142$\frac{1}{4}$"	72"	+	70"	=	142"

24" and 72" are not available in Camshelving Basics Series.

Corner Unit: Starter Unit + Add-On Unit with Corner Connectors

PREMIUM / ELEMENTS / BASICS SERIES					PREMIUM / ELEMENTS / BASICS SERIES					PREMIUM / ELEMENTS / BASICS SERIES					
ADD-ON UNIT	ADD-ON UNIT ACTUAL LENGTH		18" STARTER UNIT DEPTH	=	OVERALL LENGTH	ADD-ON UNIT ACTUAL LENGTH		21" STARTER UNIT DEPTH	=	OVERALL LENGTH	ADD-ON UNIT ACTUAL LENGTH		24" STARTER UNIT DEPTH	=	OVERALL LENGTH
24"	23"	+	18"	=	41"	23"	+	21"	=	44"	23"	+	24"	=	47"
30"	29"	+	18"	=	47"	29"	+	21"	=	50"	29"	+	24"	=	53"
36"	35"	+	18"	=	53"	35"	+	21"	=	56"	35"	+	24"	=	59"
42"	41"	+	18"	=	59"	41"	+	21"	=	62"	41"	+	24"	=	65"
48"	47"	+	18"	=	65"	47"	+	21"	=	68"	47"	+	24"	=	71"

24" unit not available in Camshelving Basics Series.

U-Shape Unit: Two Starter Units + Intermediate Shelves with Corner Connectors

PREMIUM / ELEMENTS / BASICS SERIES					PREMIUM / ELEMENTS / BASICS SERIES					PREMIUM / ELEMENTS / BASICS SERIES					
INTERMEDIATE SHELF	INTERMEDIATE SHELF ACTUAL LENGTH		18" DEPTH STARTER UNIT A+B	=	OVERALL LENGTH	INTERMEDIATE SHELF ACTUAL LENGTH		21" DEPTH STARTER UNIT A+B	=	OVERALL LENGTH	INTERMEDIATE SHELF ACTUAL LENGTH		24" DEPTH STARTER UNIT A+B	=	OVERALL LENGTH
36"	34"	+	36"	=	70"	34"	+	42"	=	76"	34"	+	48"	=	82"
42"	40"	+	36"	=	76"	40"	+	42"	=	82"	40"	+	48"	=	88"
48"	46"	+	36"	=	82"	46"	+	42"	=	88"	46"	+	48"	=	94"

CAMSHELVING® PREMIUM series

WHY CHOOSE PREMIUM?

In high volume foodservice operations with frequent deliveries and constant loading and off-loading of products, stability, strength and sanitary storage should never be compromised. Premium Series does precisely what it was designed to do – hold the heaviest products with the roughest handling, in any environment and it is the easiest to clean and adjust.

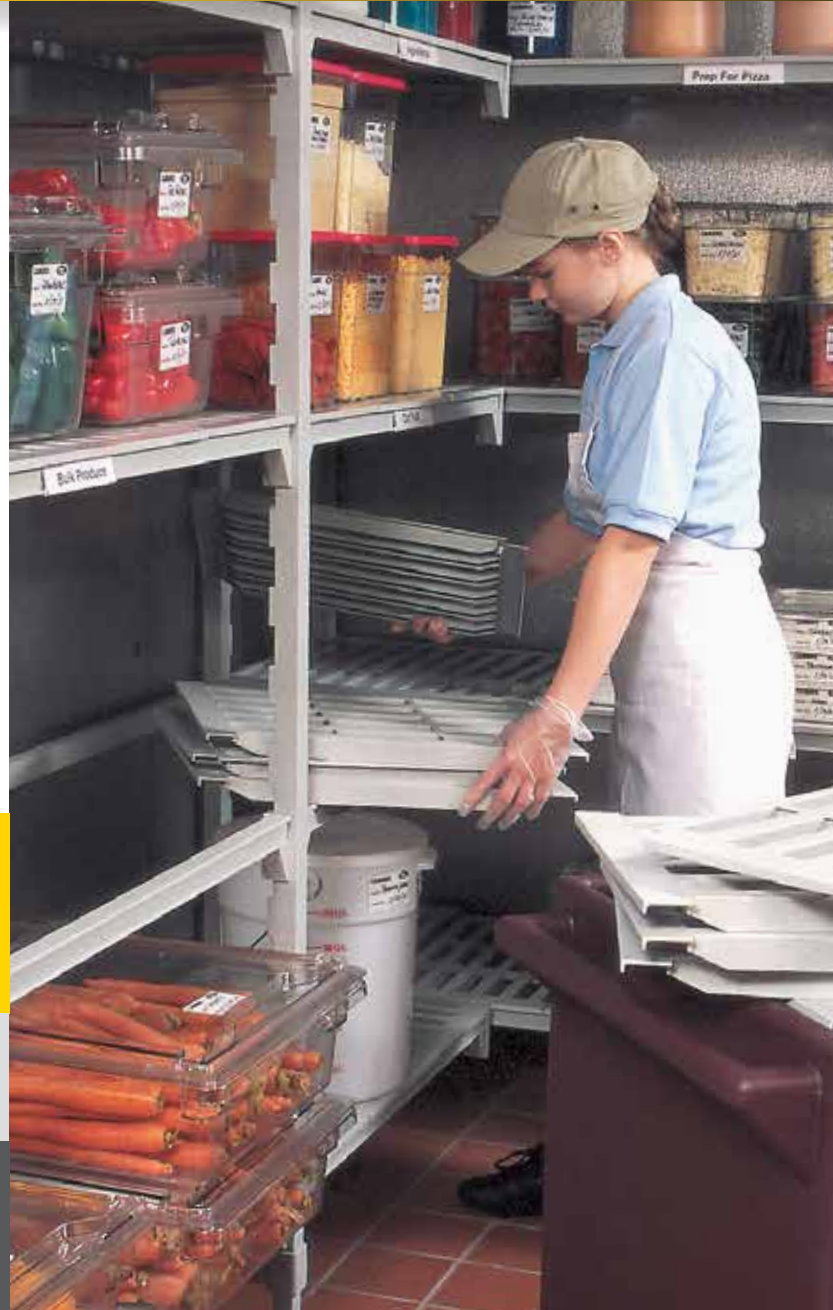
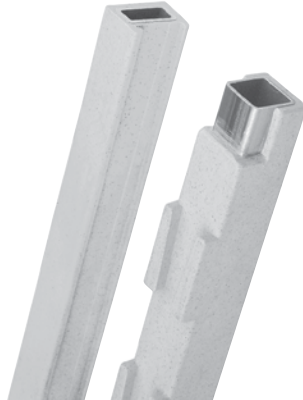

All Environments
-36°F TO 190°F

Stationary

High Density

Mobile

camguard
 ANTIMICROBIAL SHELF PLATES

storage needs
HEAVY

daily deliveries
FREQUENT



Post Connectors, Corner Connectors, Seismic Foot, Wall Fastener, Identification Tags, Full Wrap Security Cage, Single Shelf Security Cage, Tray Slide Rack, Shelf Rails, Shelf Divider Bars, High Density Track and Extension Kits are not NSF Listed.

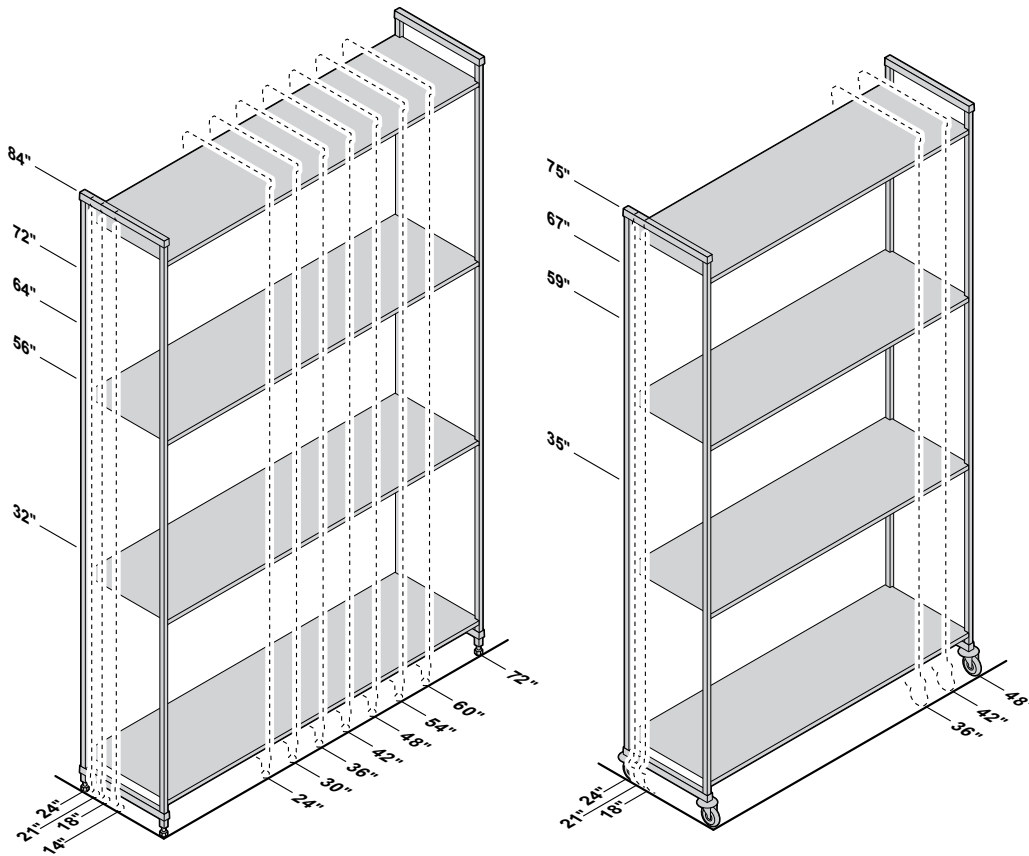

4 Shelf Unit Weight Bearing Chart

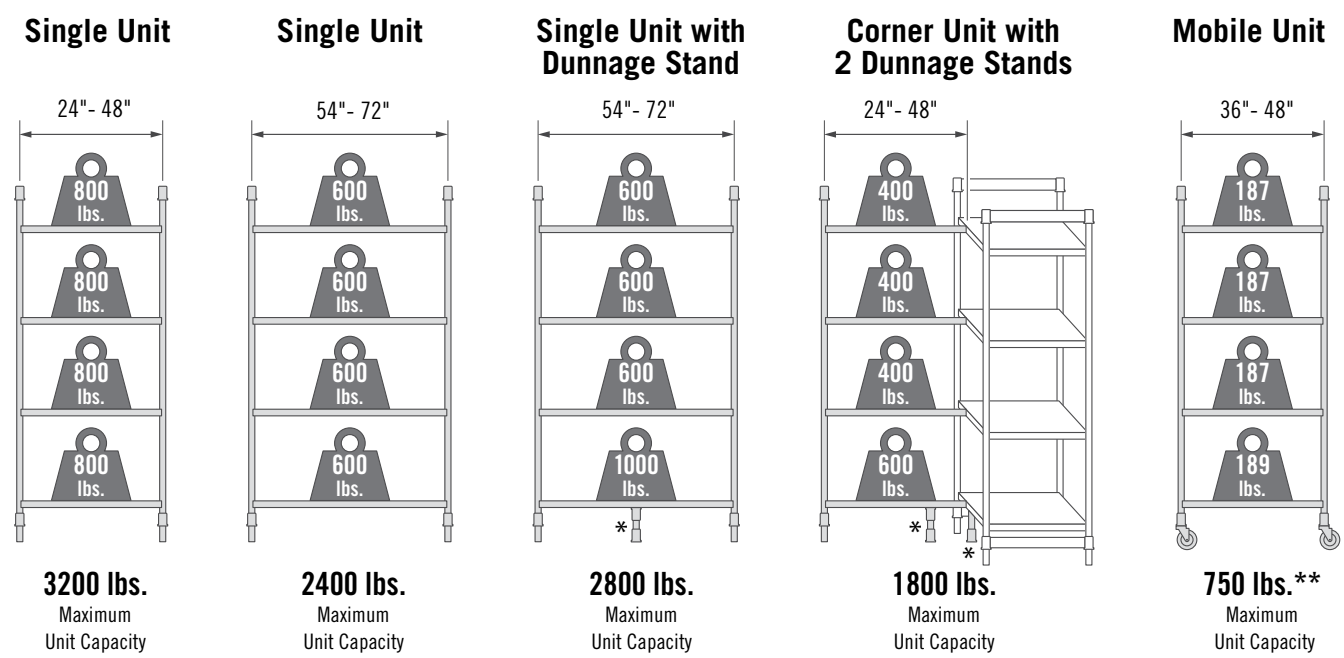

* Dunnage Stands add stability and increase weight bearing capacity on bottom shelf only. Add to any shelf length. Highly recommended for Starter Units 54" and longer, all Corner Units, U-Shape Units and units specified for heavier loads (See page 10).
 ** Due to the weight bearing capacity of casters, maximum weight load on an entire Mobile Unit is 750 lbs.

Camshelving® Premium Series

Starter, Add-On and Mobile Units

These units make ordering easy and save time and labor during installation. Units ship complete in one box.* Post kits are pre-assembled at the factory, speeding up on site set up.

*Due to unit weight and size, all 84" high units and 72" long units, all heights, ship in multiple boxes of post kits (unassembled) and shelf kits.



4-Shelf Vented Stationary Starter and Add-On Units

Starter units include 2 factory assembled post kits and shelves.

Add-On units include 1 factory assembled post kit and shelves.

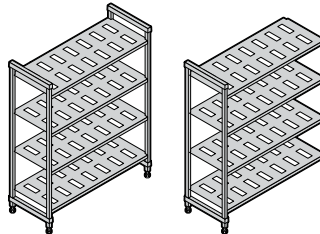

64" and 72" units ship in  1

HEIGHTS	DEPTHS	LENGTHS	
3	3	8	
64"	18"	24"	48"
72"	21"	30"	54"
84"	24"	36"	60"
		42"	72"

72" long & 84" high Add-on units ship in  2

72" long & 84" high Starter units ship in  3

4-Shelf Solid Stationary Starter and Add-On Units

Starter units include 2 factory assembled post kits and shelves.

Add-On units include 1 factory assembled post kit and shelves.

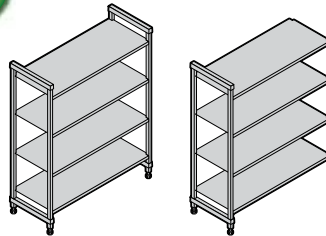

64" and 72" units ship in  1

HEIGHTS	DEPTHS	LENGTHS	
3	3	8	
64"	18"	24"	48"
72"	21"	30"	54"
84"	24"	36"	60"
		42"	72"

72" long & 84" high Add-on units ship in  2

72" long & 84" high Starter units ship in  3

4-Shelf Vented and Solid Stationary Starter and Add-On Units (3 vented + 1 solid)

Starter units include 2 factory assembled post kits and shelves.

Add-On units include 1 factory assembled post kit and shelves.

Install solid shelf on bottom to prevent water/cleaning solutions from sloshing up onto stored products. Install solid shelf on top to protect product stored on lower shelves from condensation in cooler.

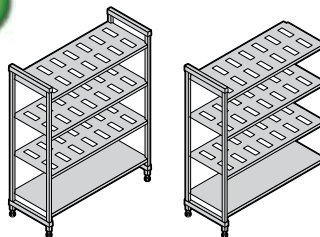

64" and 72" units ship in  1

HEIGHTS	DEPTHS	LENGTHS	
3	3	8	
64"	18"	24"	48"
72"	21"	30"	54"
84"	24"	36"	60"
		42"	72"

72" long & 84" high Add-on units ship in  2

72" long & 84" high Starter units ship in  3

5-Shelf Vented Stationary Starter and Add-On Units

Starter units include 2 factory assembled post kits and shelves.

Add-On units include 1 factory assembled post kit and shelves.

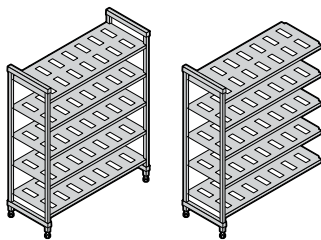

64" and 72" units ship in  1

HEIGHTS	DEPTHS	LENGTHS	
3	3	8	
64"	18"	24"	48"
72"	21"	30"	54"
84"	24"	36"	60"
		42"	72"

72" long & 84" high Add-on units ship in  2

72" long & 84" high Starter units ship in  3

5-Shelf Solid Stationary Starter and Add-On Units

Starter units include 2 factory assembled post kits and shelves.

Add-On units include 1 factory assembled post kit and shelves.

New!

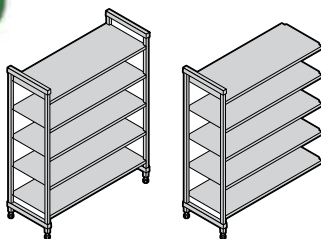

HEIGHT	DEPTHS	LENGTHS	
1	3	8	
84"	18"	24"	48"
	21"	30"	54"
	24"	36"	60"
		42"	72"

84" Add-on units ship in  2

84" Starter units ship in  3

5-Shelf Vented and Solid Stationary Starter And Add-On Units (4 vented + 1 solid)

Starter units include 2 factory assembled post kits and shelves.

Add-On units include 1 factory assembled post kit and shelves.

Install solid shelf on bottom to prevent water/cleaning solutions from sloshing up onto stored products. Install solid shelf on top to protect product stored on lower shelves from condensation in cooler.

New!

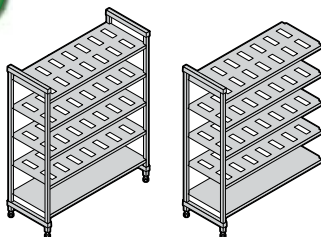

HEIGHT	DEPTHS	LENGTHS	
1	3	8	
84"	18"	24"	48"
	21"	30"	54"
	24"	36"	60"
		42"	72"

84" Add-on units ship in  2

84" Starter units ship in  3

4 or 5-Shelf Vented Mobile Starter Units

Mobile starter units include 2 factory assembled mobile post kits, shelves and 4 premium swivel casters with total locking brake.

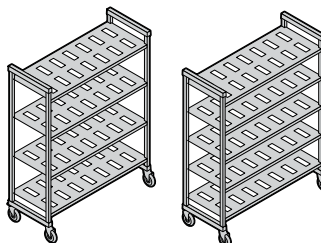

HEIGHTS*	DEPTHS	LENGTHS	
2	3	3	
67"	18"	36"	
75"	21"	42"	
	24"	48"	

* Includes 5" casters.

Ships in  1



Visit the Camshelving Microsite at www.cambro.com/camshelving for product information and pricing on ALL available shelving products. View or download the Camshelving Specification and Price List. Or scan QR code.



Camshelving® Premium Series Components

Stationary Post Kits

Post kit includes 2 unassembled stationary posts and 1 top and bottom post connector.

Stationary Posts cannot be used to build Mobile Units.



HEIGHTS	DEPTHS
5	3
32"	18"
56"	21"
64"	24"
72"	
84"	

Ships in  1

Mobile Post Kits

Mobile post kit includes 2 unassembled mobile posts, 1 top and bottom post connector and 2 premium swivel casters with total locking brake.

Mobile Posts cannot be used to build Stationary Units.



HEIGHTS*	DEPTHS
4	3
35"	18"
59"	21"
67"	24"
75"	

* Includes 5" casters.

Ships in  1

Vented and Solid Shelf Kits

For stationary or mobile units. Available as a single shelf kit or in kits of 4 or 5 shelves in 1 box, all sizes. Each kit includes shelf traverses and vented or solid shelf plates.



DEPTHS	LENGTHS	
3	8	
*18"	24"	*48"
*21"	30"	54"
*24"	*36"	60"
	*42"	72"

* 4 or 5 shelf kits available in these sizes only.

Ships in  1

Shelf Traverses

Available in single or double packs. Use a single set to add an open shelf for divider bars or drying racks. Add single traverses onto back posts for extra support when placing rolling equipment under the first shelf.



Single Pack		Double Pack
LENGTHS		LENGTHS
8		5
24"	48"	36"
30"	54"	42"
36"	60"	48"
42"	72"	54"
		60"

Ships in  1

Camshelving® Premium Series Accessories

Bottom Shelf Dunnage Stands

Increase weight bearing capacity on bottom shelf only. Add to any shelf length. Highly recommended for starter units 54" and longer and all corner units, intermediate units and units specified for heavier load volume on and off bottom shelves.

HEIGHTS*
2
7½"
11⅜"

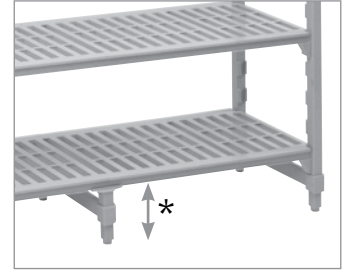
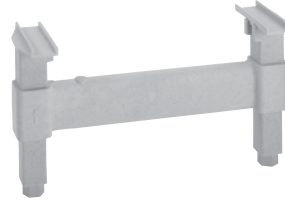

Corner Connectors

Unique patented design ensures maximum shelf space utilization. Use 1 set per shelf to connect starter and add-on units in corners. Connect 4

or 5 intermediate shelves between 2 starter units (2 sets required per shelf). Available as a single set or 8 or 10 set packs.

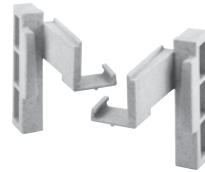

Identification Tags

Clip onto shelf traverses to clearly identify stored product. Made of highly durable plastic with a clear slide in front panel. Labels included.

LENGTHS
2
3"
6"



Wall Fastener

Use to secure stationary shelving unit to a wall for added safety and stability where required. Made of stainless steel. Screws not included.



Camshelving® Premium Series Accessories

Seismic Foot

Secure stationary unit posts directly to the floor for added safety and stability where required. Made of stainless steel. Bolts not included.



Premium Caster

Ideal in all areas of storage, especially coolers, freezers and/or wet areas. Made of highly durable, non-corrosive plastic with a 5" swivel, non-marking

thermoplastic rubber wheel. Total locking brake locks both swivel motion and the wheel.



Donut Bumper

Offers added protection during transport and when maneuvering mobile units into place against walls or alongside other units for storage.

DIAMETER
1
3½"

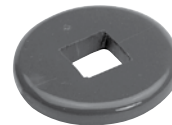

Shelf Divider

Stack and separate items stored on shelves. Made of highly durable ABS plastic. Installs directly onto solid or vented shelves. Easily removable for relocating or washing.

HEIGHT	DEPTHS
1	3
8"	18"
	21"
	24"



Camshelving® Premium Series Accessories

Shelf Divider Bars

Create a custom service or storage station for food pans, boxes or dish racks. Install straight or angled dividers directly onto shelf traverses.

DEPTH
1
24"



Shelf Rails

Install onto traverses and dovetails to prevent items from falling off sides and ends of shelves. Choose from single or double rail side kits and double rail only end kits.

DEPTHS		LENGTHS	
4		8	
14"	24"	48"	
18"	30"	54"	
21"	36"	60"	
24"	42"	72"	



4" High Double Rail



2" High Single Rail



End Rail



Tray Sliding Rack

Holds up to 6 each full size (1826) or 12 half size (1318) sheet pans or trays. Install 1 or more units onto vented shelves, any length. High quality, lightweight aluminum material is safe for use in coolers and freezers. Made from aluminum 6463 (6000 series).

DEPTH
1
24"



Single Shelf Security Cage

Securely store valuable products on a single shelf. Made of heavy duty, 304 stainless steel for use in any environment. Requires 18" height between shelves. Install on vented shelves only. Lock not included.

DEPTH	LENGTH
1	1
24"	42"



Camshelving® Premium Series Accessories

Full-Wrap Security Cage

Store valuable products behind locked doors. Made of heavy-duty 304 stainless steel for use in any environment. Stationary or mobile units ship complete with factory assembled post kits, 2 vented shelves, 4 premium swivel casters with total locking brake for mobile unit and 1 full wrap security cage. Assembly required. Lock not included.

Stationary HEIGHT	Mobile HEIGHT*	DEPTH	LENGTH
1	1	1	1
64"	67"	24"	48"

* Includes 5" casters.



Cage only ships in  1 Units ship in  2

Vertical Drying and Storage Cradle

Modular 7-slot rack designed for drying and storing trays, sheet pans, cutting boards and lids. Installs directly onto shelf traverses. Made of highly durable ABS plastic. Available in single or 3 pack.

DEPTH
1
24"



Vertical Drying and Storage Rack



Promotes sanitary drying, safe handling and efficient product organization with easy access to product.

Units ship complete with factory assembled mobile post kits, 6 traverses, 12 or 15 vertical drying cradles and premium swivel casters with total locking brake. Assembly required.

HEIGHT*	DEPTH	LENGTHS	HOLDS
1	1	2	Trays
75"	24"	48" 60"	84 105

* Includes 5" casters.



48" long unit ships in  5 60" long unit ships in  6

Camshelving® Premium Series Accessories

Dome Drying and Storage Cradle

Use to dry and safely store up to 10 patient meal delivery domes or plate covers upright. Installs directly onto shelf traverses. Made of highly durable ABS plastic. Available in single or 5 pack.

DEPTH
1
21"



Dome Drying and Storage Rack

Promotes sanitary drying, safe handling and efficient product organization with easy access to product.

Unit ships complete with factory assembled mobile post kits, 10 traverses, 10 dome drying cradles and premium swivel casters with total locking brake. Assembly required.

HEIGHT*	DEPTH	LENGTH	HOLDS
1	1	1	Domes
75"	21"	36"	100

* Includes 5" casters.



Ships in



Angled Drying and Storage Cradle

Uniquely designed cradle holds up to 8 each meal delivery pellets. Also can be used to dry, store and transport food pans and other commercial kitchen ware. Installs directly onto shelf traverses. Made of highly durable ABS plastic. Available in single or 4 pack.

DEPTH
1
24"



Angled Drying and Storage Rack

Promotes sanitary drying, safe handling and efficient product organization with easy access to product.

Unit ships complete with factory assembled mobile post kits, 8 traverses, 16 angled drying cradles and premium swivel casters with total locking brake. Assembly required.

HEIGHT*	DEPTH	LENGTH	HOLDS
1	1	1	Pellets, Bases / GN¹/₂ / Food Pans
75"	24"	48"	128 / 16

* Includes 5" casters.



Ships in



Camshelving® Premium Series

High Density Storage Floor Track System

Maximize storage capacity by creating storage aisles in available space. This simple system is composed of stationary starter units anchored to a raised floor track system at both ends with high density mobile units installed in between. Easy to install track requires no drilling or gluing.



High Density Mobile Units are available with factory assembled post kits, vented or solid shelves and high density casters and bumpers. Full track and extension kits ship complete with required hardware. Stationary Starter Units are required to anchor the system at both ends.

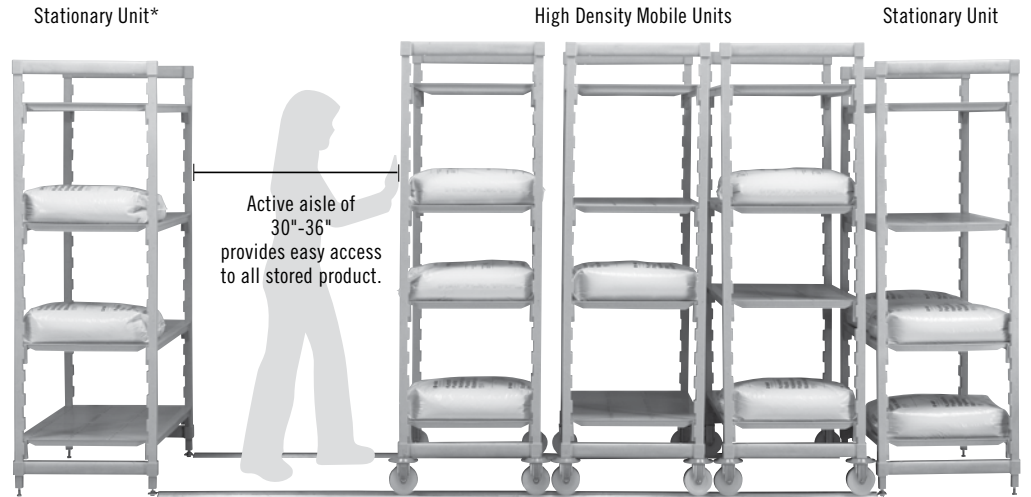

Raised Floor Track provides a smooth and level surface to easily roll mobile units. Raised track ensures dirt will not get trapped and is easy to clean. Aluminum track and stainless steel hardware are rust resistant.



Grooved casters roll easily and securely on raised track.

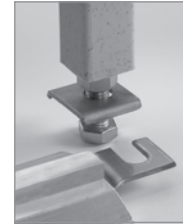

Raised track connects easily to the bottom of a stationary unit that works as a system anchor. No bolts, no glue or drilling into the floor are required. Easy and fast set up.

* It is recommended to use a stationary unit for every 15' of track to further stabilize the system.

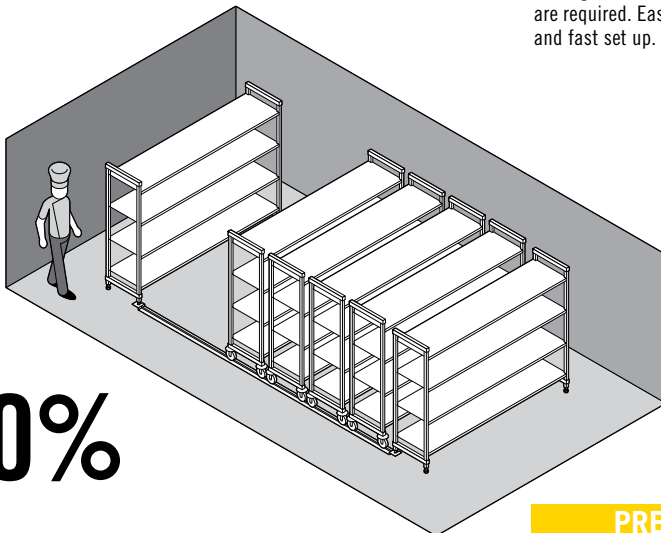
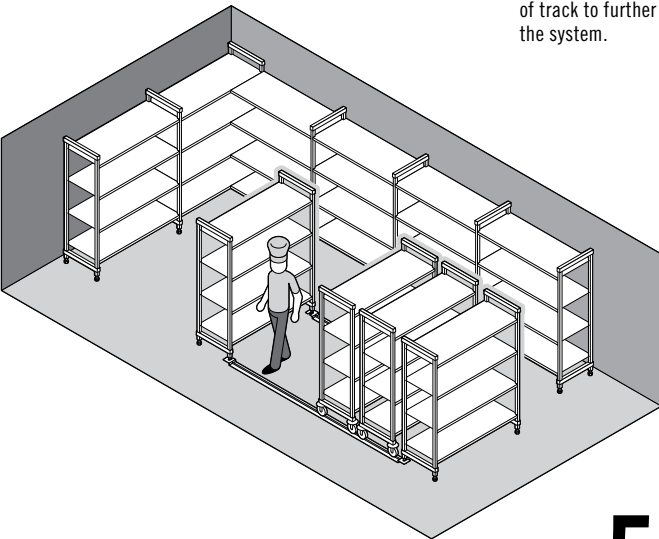

Increases Storage Capacity Up To **50%**

4-Shelf Vented High Density Mobile Starter Units

Units include 2 factory assembled mobile post kits, 4 shelves, 4 high density casters and 4 high density bumpers.

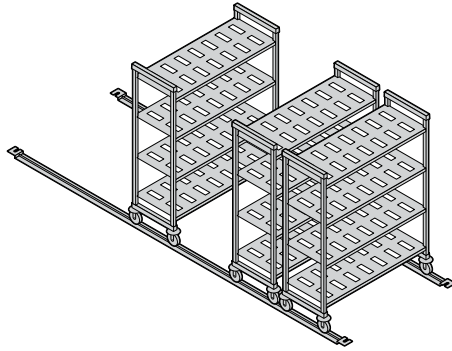

HEIGHTS*	DEPTHS	LENGTHS
2	2	5
67"	18"	36"
75"	21"	42"
	24"	48"
		54"
		60"

* Includes 5" casters.

Ships in  1

4-Shelf Solid High Density Mobile Starter Units

Units include 2 factory assembled mobile post kits, 4 shelves, 4 high density casters and 4 high density bumpers.

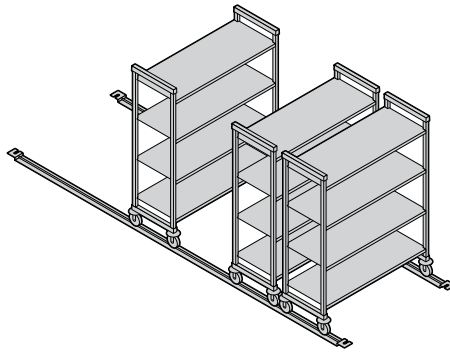

HEIGHTS*	DEPTHS	LENGTHS
2	2	5
67"	18"	36"
75"	21"	42"
	24"	48"
		54"
		60"

* Includes 5" casters.

Ships in  1

Full Track and Extension Kits

Aluminum raised track kits and track extensions ship complete in 1 box. Each kit includes all stainless steel hardware necessary to complete a floor installation.

It is highly recommended to install a stationary starter unit every 15' of track to further stabilize the system.

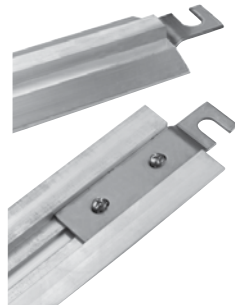

Full Track LENGTHS	Track Extension LENGTHS
3	3
10'	4.5'
12'	5'
14.5'	6'

Ships in  1

High Density Caster with Donut Bumper

Grooved caster rolls easily and securely on raised track. Donut bumper protects mobile units from coming into direct contact with each other.





CAMSHELVING® ELEMENTS series

WHY CHOOSE ELEMENTS?

Made from a revolutionary, extremely strong composite material with a smooth, easy to clean surface. Elements Series is stronger than common wire shelving. It's lighter in weight than Camshelving Premium Series and totally impervious to moisture, chemicals and liquids that can destroy shelving over time. Elements Series is designed for medium to heavy storage use in freezers, coolers, dry storage or warewashing areas. It easily supports the performance demands of a busy foodservice operation.



All Environments
-36°F TO 190°F

Stationary

Mobile

camguard
 ANTIMICROBIAL SHELF PLATES



Post Connectors, Corner Connectors, Seismic Foot, Wall Fastener, Identification Tags, Single Shelf Security Cage, Tray Slide Rack, and Shelf Divider Bars are not NSF Listed.

storage needs

MEDIUM to HEAVY

weekly deliveries

5 – 7

Camshelving® Elements Series
Stationary Unit Sizes

Mobile Unit Sizes

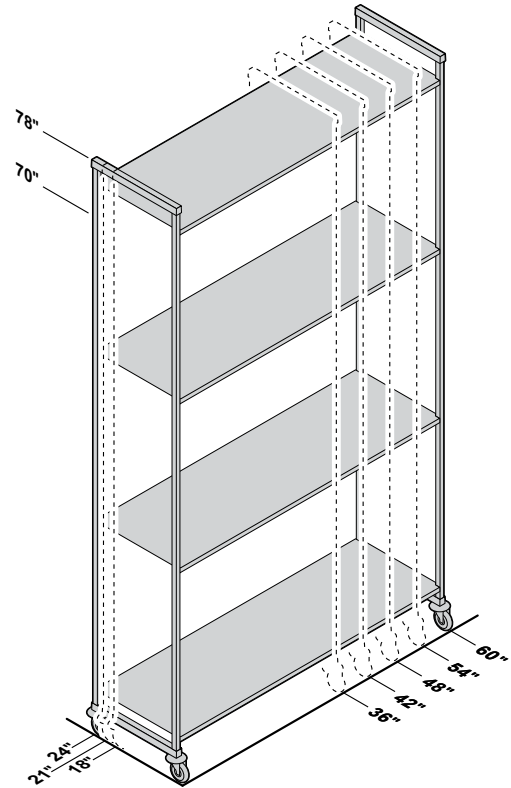
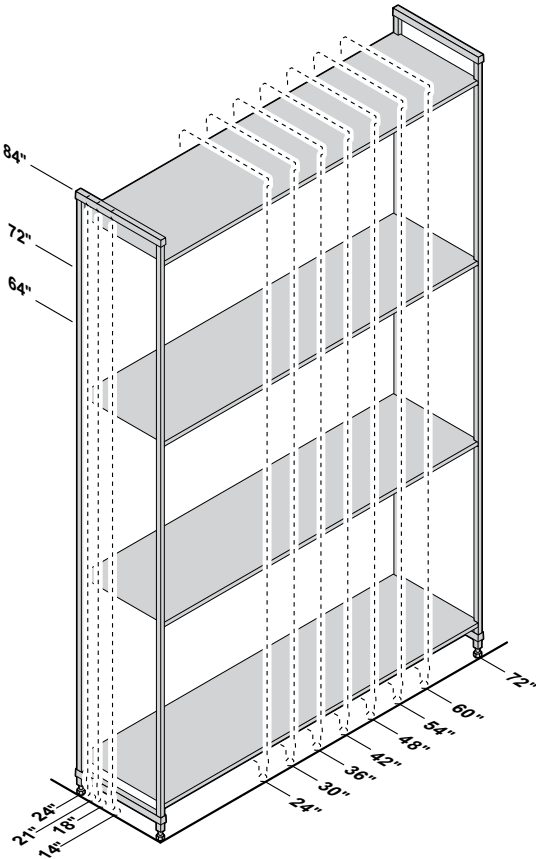

4 Shelf Unit Weight Bearing Chart

Single Unit

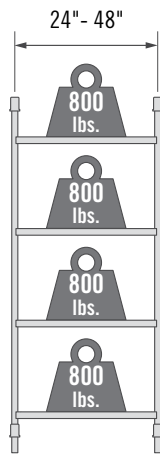

3200 lbs.
 Maximum
 Unit Capacity

Single Unit

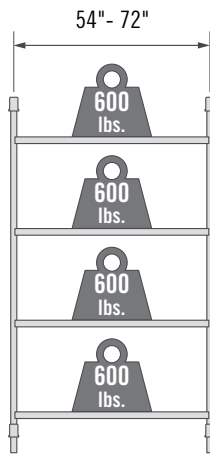

2400 lbs.
 Maximum
 Unit Capacity

**Single Unit with
 Dunnage Stand**

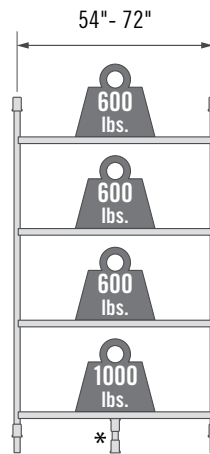

2800 lbs.
 Maximum
 Unit Capacity

**Corner Unit with
 2 Dunnage Stands**

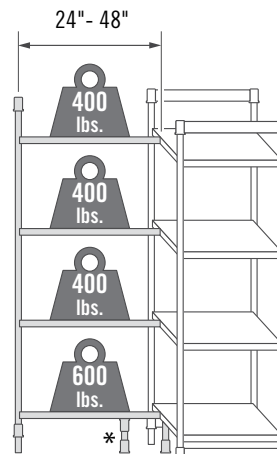

1800 lbs.
 Maximum
 Unit Capacity

Mobile Unit

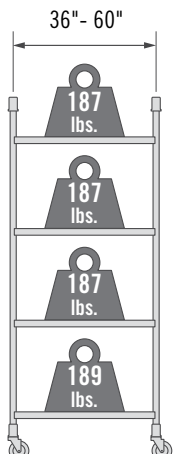

750 lbs.**
 Maximum
 Unit Capacity

* Dunnage Stands add stability and increase weight bearing capacity on bottom shelf only. Add to any shelf length. Highly recommended for Starter Units 54" and longer, all Corner Units, U-Shape Units and units specified for heavier loads (See page 10).

** Due to the weight bearing capacity of casters, maximum weight load on an entire Mobile Unit is 750 lbs.

Camshelving® Elements Series

Starter, Add-On and Mobile Units

These units make ordering easy and saves time and labor during installation. Units ship complete in one box. Post kits are pre-assembled at the factory, speeding up on site set up.



4-Shelf Vented Stationary Starter and Add-On Units

Starter units include 2 factory assembled post kits and shelves.
Add-On units include 1 factory assembled post kit and shelves.

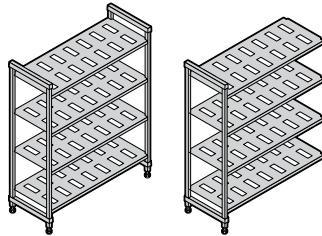

HEIGHTS	DEPTHS	LENGTHS	
3	3	8	
64"	18"	24"	48"
72"	21"	30"	54"
84"	24"	36"	60"
		42"	72"

Ships in  1

4-Shelf Solid Stationary Starter and Add-On Units

Starter units include 2 factory assembled post kits and shelves.
Add-On units include 1 factory assembled post kit and shelves.

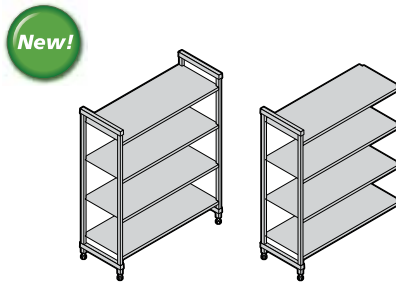

HEIGHTS	DEPTHS	LENGTHS	
3	3	8	
64"	18"	24"	48"
72"	21"	30"	54"
84"	24"	36"	60"
		42"	72"

Ships in  1

4-Shelf Vented and Solid Stationary Starter and Add-On Units (3 vented + 1 solid)

Starter units include 2 factory assembled post kits and shelves.
Add-On units include 1 factory assembled post kit and shelves.
Install solid shelf on bottom to prevent water/cleaning solutions from sloshing up onto stored products. Install solid shelf on top to protect product stored on lower shelves from condensation in cooler.

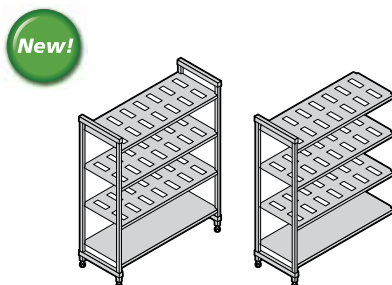

HEIGHTS	DEPTHS	LENGTHS	
3	3	8	
64"	18"	24"	48"
72"	21"	30"	54"
84"	24"	36"	60"
		42"	72"

Ships in  1

5-Shelf Vented Stationary Starter and Add-On Units

Starter units include 2 factory assembled post kits and shelves.

Add-On units include 1 factory assembled post kit and shelves.

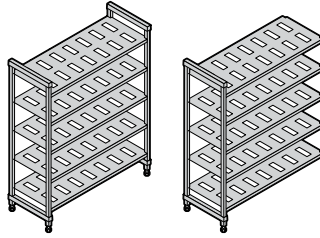

HEIGHTS	DEPTHS	LENGTHS	
3	3	8	
64"	18"	24"	48"
72"	21"	30"	54"
84"	24"	36"	60"
		42"	72"

Ships in  1

5-Shelf Solid Stationary Starter and Add-On Units

Starter units include 2 factory assembled post kits and shelves.

Add-On units include 1 factory assembled post kit and shelves.

New!

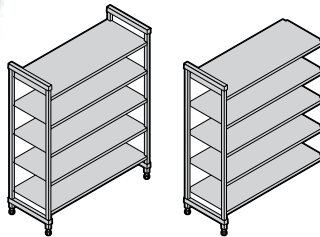

HEIGHT	DEPTHS	LENGTHS	
1	3	8	
84"	18"	24"	48"
	21"	30"	54"
	24"	36"	60"
		42"	72"

Ships in  1

5-Shelf Vented and Solid Stationary Starter And Add-On Units (4 vented + 1 solid)

Starter units include 2 factory assembled post kits and shelves.

Add-On units include 1 factory assembled post kit and shelves.

Install solid shelf on bottom to prevent water/cleaning solutions from sloshing up onto stored products.
Install solid shelf on top to protect product stored on lower shelves from condensation in cooler.

New!

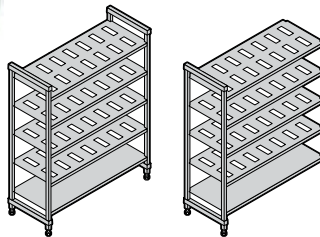

HEIGHT	DEPTHS	LENGTHS	
1	3	8	
84"	18"	24"	48"
	21"	30"	54"
	24"	36"	60"
		42"	72"

Ships in  1

4 or 5-Shelf Vented Mobile Starter Units

Mobile starter units include 2 factory assembled mobile post kits, shelves and 4 premium swivel casters with total locking brake.

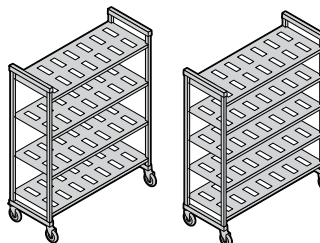

HEIGHTS*	DEPTHS	LENGTHS	
2	3	5	
70"	18"	36"	54"
78"	21"	42"	60"
	24"	48"	

* Includes 5" casters.

Ships in  1



Visit the Camshelving Microsite at www.cambro.com/camshelving for product information and pricing on ALL available shelving products. View or download the Camshelving Specification and Price List. Or scan QR code.



Camshelving® Elements Series Components

Stationary Post Kits

Post kit includes 2 unassembled stationary posts, 1 top and bottom post connector and post connector wedges.

Stationary Posts cannot be used to build Mobile Units.



HEIGHTS	DEPTHS
3	4
64"	14"
72"	18"
84"	21"
	24"

Ships in 1

Mobile Post Kits

Mobile post kit includes 2 unassembled mobile posts, 1 top and bottom post connector, post connector wedges, and 2 premium swivel casters with total locking brake.

Mobile Posts cannot be used to build Stationary Units.

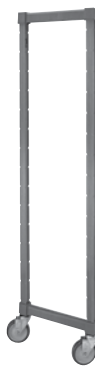

HEIGHTS	DEPTHS
2	3
70"	18"
78"	21"
	24"

Ships in 1

Vented and Solid Shelf Kits

For stationary or mobile units. Available as a single shelf or kits of 4 or 5 shelves. Each kit includes stationary or mobile shelf traverses, stationary or mobile shelf traverse dovetails and vented or solid shelf plates.



Stationary		Mobile	
DEPTHS	LENGTHS	DEPTHS	LENGTHS
4	8	3	5
14"	24" *48"	18"	36"
*18"	30" 54"	21"	42"
*21"	*36" 60"	24"	48"
*24"	*42" 72"		54"
			60"

* 4 or 5 shelf kits available in these sizes only.

Ships in 1

Shelf Traverses

Available in single or double packs, stationary or mobile. Use two traverses to add an open shelf for divider bars or drying cradles. Add one stationary traverse onto back posts of a stationary unit for extra support when placing rolling equipment under the first shelf. Traverse dovetails included.



Stationary		Mobile	
Single Pack LENGTHS	Double Pack LENGTHS	Single Pack LENGTHS	Double Pack LENGTHS
8	5	5	5
24"	48"	36"	36"
30"	54"	42"	42"
36"	60"	48"	48"
42"	72"	54"	54"
	60"	60"	60"

Ships in 1

Camshelving® Elements Series Accessories

Bottom Shelf Dunnage Stands

Increase weight bearing capacity on bottom shelf only. Add to any shelf length. Highly recommended for starter units 54" and longer and all corner units, intermediate units and units specified for heavier load volume on and off bottom shelves.

HEIGHTS*

2

New!
6½"
10½"

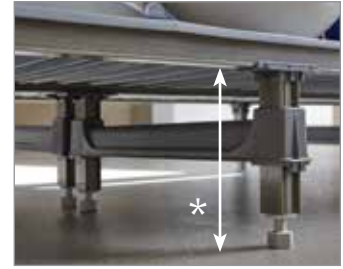

Corner Connectors

Unique patented design ensures maximum shelf space utilization. Use 1 set per shelf to connect starter and add-on units in corners. Connect 4

or 5 intermediate shelves between 2 starter units (2 sets required per shelf). Available as a single set or 8 or 10 set packs.



Identification Tags

Clip onto shelf traverses to clearly identify stored product. Made of highly durable plastic with a clear slide in front panel. Labels included.

LENGTHS

2

3"
6"



Wall Fastener

Use to secure stationary shelving unit to a wall for added safety and stability where required. Made of stainless steel. Screws not included.



Seismic Foot

Secure stationary unit posts directly to the floor for added safety and stability where required. Made of stainless steel. Bolts not included.



Camshelving® Elements Series Accessories

Premium Caster

Ideal in all areas of storage, especially coolers, freezers and/or wet areas. Made of highly durable, non-corrosive plastic with a 5" swivel, non-marking

thermoplastic rubber wheel. Total locking brake locks both swivel motion and the wheel.



Donut Bumper

Offers added protection during transport and when maneuvering mobile units into place against walls or alongside other units for storage.

DIAMETER
1
5"

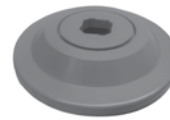

Shelf Divider

Stack and separate items stored on shelves. Made of highly durable ABS plastic. Installs directly onto solid or vented shelves. Easily removable for relocating or washing.

HEIGHT	DEPTHS
1	3
8"	18"
	21"
	24"



Shelf Divider Bars

Create a custom service or storage station for food pans, boxes or dish racks. Install straight or angled dividers directly onto shelf traverses.

DEPTH
1
24"



Tray Sliding Rack

Holds up to 6 each full size (1826) or 12 half size (1318) sheet pans or trays. Install 1 or more units onto vented shelves, any length. High quality, lightweight aluminum material is safe for use in coolers and freezers. Made from aluminum 6463 (6000 series).

DEPTH
1
24"



Camshelving® Elements Series Accessories

Single Shelf Security Cage

Securely store valuable products on a single shelf. Made of heavy duty, 304 stainless steel for use in any environment. Requires 18" height between shelves. Install on vented shelves only. Lock not included.

DEPTH	LENGTH
1	1
24"	42"



Vertical Drying and Storage Cradle

Modular 7-slot rack designed for drying and storing trays, sheet pans, cutting boards and lids. Installs directly onto shelf traverses. Made of highly durable ABS plastic. Available in single or 3 pack.

DEPTH
1
24"



Vertical Drying and Storage Rack

Promotes sanitary drying, safe handling and efficient product organization with easy access to product.

HEIGHT*	DEPTH	LENGTHS	HOLDS
1	1	2	Trays
78"	24"	48"	84
		60"	105

* Includes 5" casters.

Units ship complete with factory assembled mobile post kits, 6 mobile shelf traverses, mobile shelf traverse dovetails, 12 or 15 vertical drying cradles and premium swivel casters with total locking brake. Assembly required.

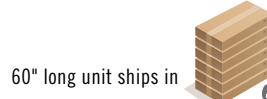
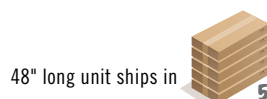

Camshelving® Elements Series Accessories

Dome Drying and Storage Cradle

Use to dry and safely store up to 10 patient meal delivery domes or plate covers upright. Installs directly onto shelf traverses. Made of highly durable ABS plastic. Available in single or 5 pack.

DEPTH
1
21"



Angled Drying and Storage Cradle

Uniquely designed cradle holds up to 8 each meal delivery pellets. Also can be used to dry, store and transport food pans and other commercial kitchen ware. Installs directly onto shelf traverses. Made of highly durable ABS plastic. Available in single or 4 pack.

DEPTH
1
24"



Angled Drying and Storage Rack

Promotes sanitary drying, safe handling and efficient product organization with easy access to product.

Unit ships complete with factory assembled mobile post kits, 8 mobile shelf traverses, mobile shelf traverse dovetails, 16 angled drying cradles and premium swivel casters with total locking brake. Assembly required.

HEIGHT*	DEPTH	LENGTH	HOLDS
1	1	1	Pellets, Bases / GN'/ Food Pans
78"	24"	48"	128 / 16

* Includes 5" casters.



Ships in 5

CAMSHELVING® **BASICS** series

WHY CHOOSE BASICS?

Just because the budget is tight and storage needs are less rigorous, it doesn't mean that shelving performance and storage efficiencies should be compromised. Basics Series is made from the same high performing, strong composite material as Elements Series and has the same design features. It's lighter in weight and less in cost but still strong enough to handle light to medium storage demands.



All Environments
-36°F TO 190°F

Stationary



storage needs

LIGHT to MEDIUM

weekly deliveries

2 – 5

Camshelving® Basics Series Stationary Unit Sizes

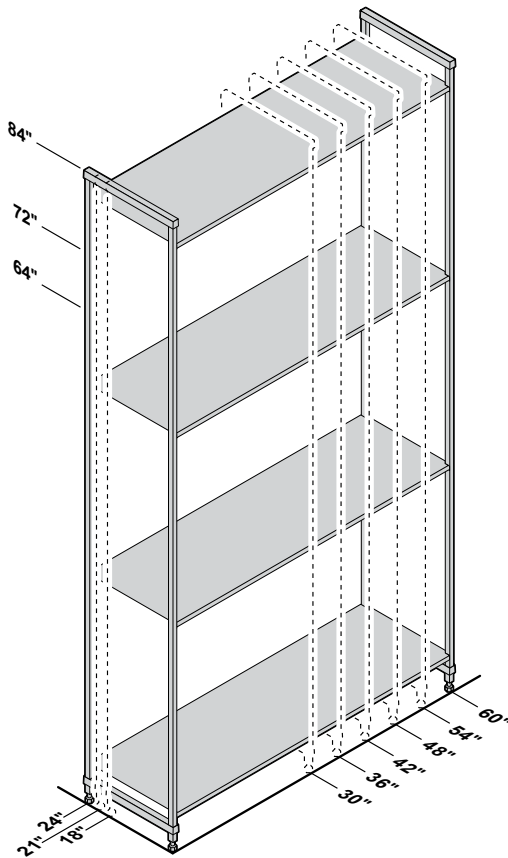

4 Shelf Unit Weight Bearing Chart

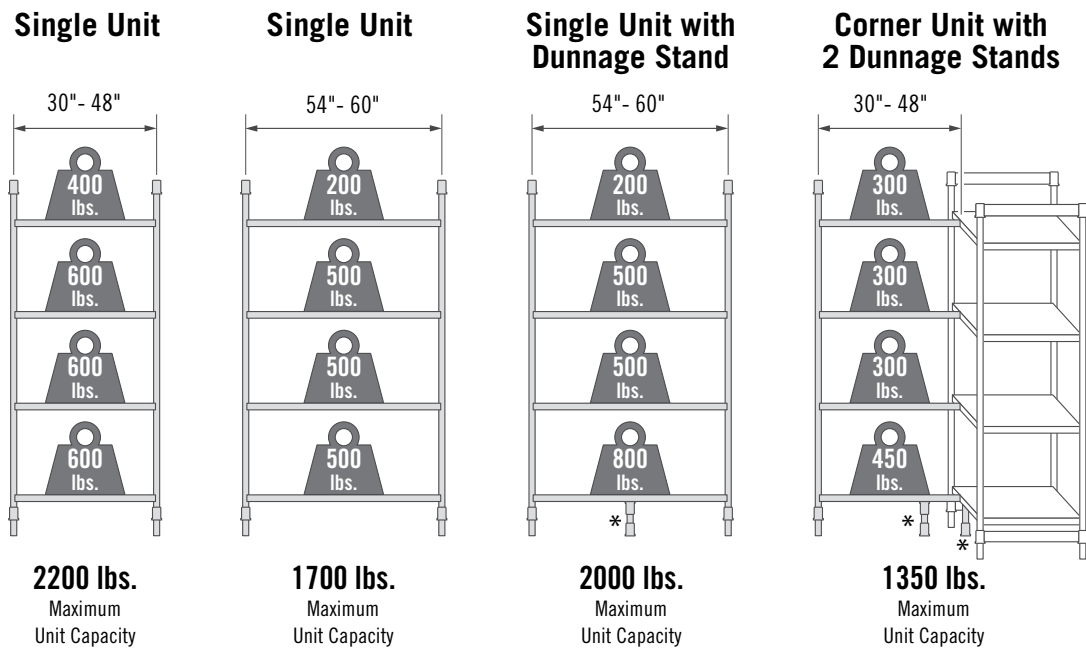

* Dunnage Stands add stability and increase weight bearing capacity on bottom shelf only. Add to any shelf length. Highly recommended for Starter Units 54" and longer, all Corner Units, U-Shape Units and units specified for heavier loads (see page 10).

Camshelving® Basics Series

Starter, and Add-On Units

These units make ordering easy and saves time and labor during installation. Units ship complete in one box. Post kits are pre-assembled at the factory, speeding up on site set up.



4-Shelf Vented Stationary Starter and Add-On Units

Starter units include 2 factory assembled post kits and shelves.

Add-On units include 1 factory assembled post kit and shelves.

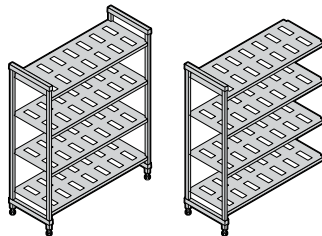

HEIGHTS	DEPTHS	LENGTHS
3	3	6
64"	18"	30" 48"
72"	21"	36" 54"
84"	24"	42" 60"

Ships in  1

4-Shelf Solid Stationary Starter and Add-On Units

Starter units include 2 factory assembled post kits and shelves.

Add-On units include 1 factory assembled post kit and shelves.

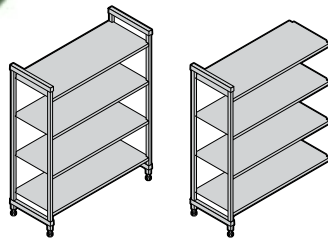

HEIGHTS	DEPTHS	LENGTHS
3	3	6
64"	18"	30" 48"
72"	21"	36" 54"
84"	24"	42" 60"

Ships in  1

4-Shelf Vented and Solid Stationary Starter and Add-On Units (3 vented + 1 solid)

Starter units include 2 factory assembled post kits and shelves.

Add-On units include 1 factory assembled post kit and shelves.

Install solid shelf on bottom to prevent water/cleaning solutions from sloshing up onto stored products. Install solid shelf on top to protect product stored on lower shelves from condensation in cooler.

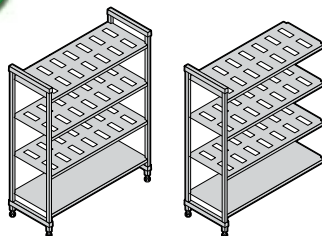

HEIGHTS	DEPTHS	LENGTHS
3	3	6
64"	18"	30" 48"
72"	21"	36" 54"
84"	24"	42" 60"

Ships in  1

5-Shelf Vented Stationary Starter and Add-On Units

Starter units include 2 factory assembled post kits and shelves.

Add-On units include 1 factory assembled post kit and shelves.

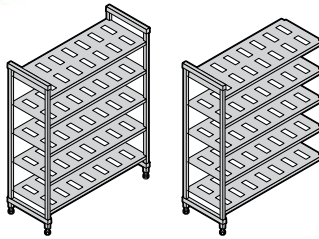

HEIGHTS	DEPTHS	LENGTHS	
3	3	6	
64"	18"	30"	48"
72"	21"	36"	54"
84"	24"	42"	60"

Ships in 1

5-Shelf Solid Stationary Starter and Add-On Units

Starter units include 2 factory assembled post kits and shelves.

Add-On units include 1 factory assembled post kit and shelves.

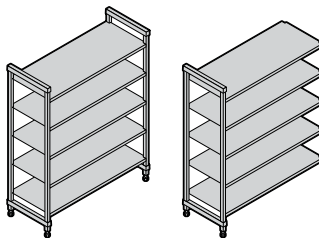

HEIGHT	DEPTHS	LENGTHS	
1	3	6	
84"	18"	30"	48"
	21"	36"	54"
	24"	42"	60"

Ships in 1

5-Shelf Vented and Solid Stationary Starter And Add-On Units (4 vented + 1 solid)

Starter units include 2 factory assembled post kits and shelves.

Add-On units include 1 factory assembled post kit and shelves.

Install solid shelf on bottom to prevent water/cleaning solutions from sloshing up onto stored products.

Install solid shelf on top to protect product stored on lower shelves from condensation in cooler.

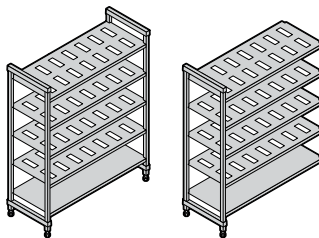

HEIGHT	DEPTHS	LENGTHS	
1	3	6	
84"	18"	30"	48"
	21"	36"	54"
	24"	42"	60"

Ships in 1



Visit the Camshelving Microsite at www.cambro.com/camshelving for product information and pricing on ALL available shelving products. View or download the Camshelving Specification and Price List. Or scan QR code.



Camshelving® Basics Series Components

Stationary Post Kits

Post kit includes 2 unassembled stationary posts, 1 top and bottom post connector and post connector wedges.

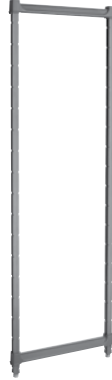

HEIGHTS	DEPTHS
3	3
64"	18"
72"	21"
84"	24"

Ships in  4

Vented and Solid Shelf Kits

Available as a single shelf or kits of 4 or 5 shelves. Each kit includes shelf traverses, shelf traverse dovetails and vented or solid shelf plates.



DEPTHS	LENGTHS
3	6
*18"	30"
*21"	*36"
*24"	*42"
	*48"
	54"
	60"

* 4 or 5 shelf kits available in these sizes only.

Ships in  4

Shelf Traverses

Add one traverse onto back posts for extra support when placing rolling equipment under the first shelf. Traverse dovetails included.



Single Pack

LENGTHS

6

30"
36"
42"
48"
54"
60"

Ships in  4

Camshelving® Basics Series Accessories

Bottom Shelf Dunnage Stands

Increase weight bearing capacity on bottom shelf only. Add to any shelf length. Highly recommended for starter units 54" and longer and all corner units, intermediate units and units specified for heavier load volume on and off bottom shelves.

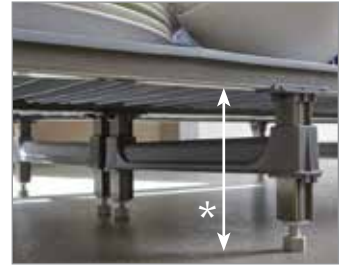
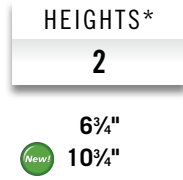

Corner Connectors

Unique patented design ensures maximum shelf space utilization. Use 1 set per shelf to connect starter and add-on units in corners. Connect 4

or 5 intermediate shelves between 2 starter units (2 sets required per shelf). Available as a single set or 8 or 10 set packs.



Identification Tag

Clip onto shelf traverses to clearly identify stored product. Made of highly durable plastic with a clear slide in front panel. Labels included.

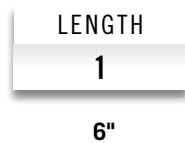

Wall Fastener

Use to secure stationary shelving unit to a wall for added safety and stability where required. Made of stainless steel. Screws not included.



Seismic Foot

Secure stationary unit posts directly to the floor for added safety and stability where required. Made of stainless steel. Bolts not included.

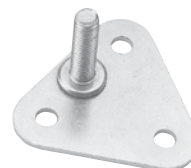

Additional Camshelving® Accessories

Camrack® Open End Tray Rack

Open end on one side for easy placement and removal of shelf plates.

HOLDS
Shelf Plates
9



Camshelving® Wall Shelves

Features virtually indestructible I-beam supports that hold up to 150 lbs. per shelf. Durable polypropylene withstands temperatures up to 190°F, and will not rust or corrode. Includes all hardware for installation. Easy to remove and clean without tools.

DEPTHS	LENGTHS
2	2
14"	36"
18"	48"



COMPONENT



Shelf Extenders

Convert empty wall space into a functional, vertical storage area. Peg strips withstand temperatures up to 190°F, and will not rust or corrode.

LENGTHS
2
36"
48"



S-Series Dunnage Racks

Keep frozen, cold or dry inventory 12" safely off the floor. Heavy duty polypropylene is safe to -36°F, and will not rust, corrode or bend.

HEIGHT	DEPTH	LENGTHS	Weight CAPACITY
1	1	4	LBS
12"	21"	30"	1500
		36"	3000
		48"	
		60"	



Camlink® Connectors

Securely lock dunnage racks together for greater stability.



CAMBRO
TRUSTED FOR GENERATIONS™

Camshelving

STORAGE

REDEFINED

INTRODUCTION

NEW TO SHELVING?



START HERE



BASICS

PREMIUM

ELEMENTS

COMPARE ALL 3

STRENGTH



MAX WEIGHT

Which shelf carries the right load for you?

CHECK IT OUT



CODE LOOKUP



SHELVING LAYOUTS



WATCH VIDEOS



VIEW GALLERY

SHELVING DESIGN SERVICE. ON THE HOUSE.
Connect with our design center to launch your Shelving For Life experience.

- Home
- Compare All Three
- New To Shelving?
- Weight Test
- Code Lookup
- Shelving Layouts
- Videos
- Gallery
- Assembly
- The Shelf Life: Tips & Ideas
- Shelving For Life Customers
- FREE Design Service
- Warranty
- Cambro Blog

Visit the Camshelving Microsite at www.cambro.com/camshelving for product information and pricing on ALL available shelving products. View or download the Camshelving Specification and Price List. Or scan QR code.

